



US00D534172S

(12) **United States Design Patent**
Chen et al.

(10) **Patent No.:** **US D534,172 S**

(45) **Date of Patent:** **** Dec. 26, 2006**

(54) **COMPUTER FRONT BEZEL**

(75) Inventors: **Yun-Lung Chen**, Tu-Cheng (TW);
Hong-Jin Wu, Shen-Zhen (CN)

(73) Assignee: **Hon Hai Precision Industry Co. Ltd.**,
Taipei Hsien (TW)

(**) Term: **14 Years**

(21) Appl. No.: **29/243,461**

(22) Filed: **Nov. 23, 2005**

(30) **Foreign Application Priority Data**

Jul. 21, 2005 (CN) 200530064864

(51) **LOC (8) Cl.** **14-02**

(52) **U.S. Cl.** **D14/444**

(58) **Field of Classification Search** D14/441-446;
D13/162, 184, 199; 312/223.2; 360/99.01-99.12;
361/680-686, 690-696; 369/34.01, 36.01
See application file for complete search history.

(56) **References Cited**

U.S. PATENT DOCUMENTS

5,547,272 A * 8/1996 Paterson et al. 312/223.2

D431,825 S * 10/2000 Jean et al. D14/444
D432,135 S * 10/2000 Jean et al. D14/444
D439,254 S * 3/2001 Zhao D14/441
D491,569 S * 6/2004 Chen et al. D14/444

* cited by examiner

Primary Examiner—Freda S. Nunn

(74) *Attorney, Agent, or Firm*—Jeffrey T. Knapp

(57) **CLAIM**

The ornamental design for a computer front bezel, as shown and described.

DESCRIPTION

FIG. 1 is a perspective view of a computer front bezel of our new design;

FIG. 2 is a front elevational view thereof;

FIG. 3 is a rear elevational view thereof;

FIG. 4 is a left side elevational view thereof;

FIG. 5 is a right side elevational view thereof;

FIG. 6 is a top plan view thereof;

FIG. 7 is a bottom plan view thereof; and,

FIG. 8 is a perspective view thereof being mounted to a computer case which is shown in broken lines for illustrative purposes only and forms no part of the claimed design.

1 Claim, 6 Drawing Sheets

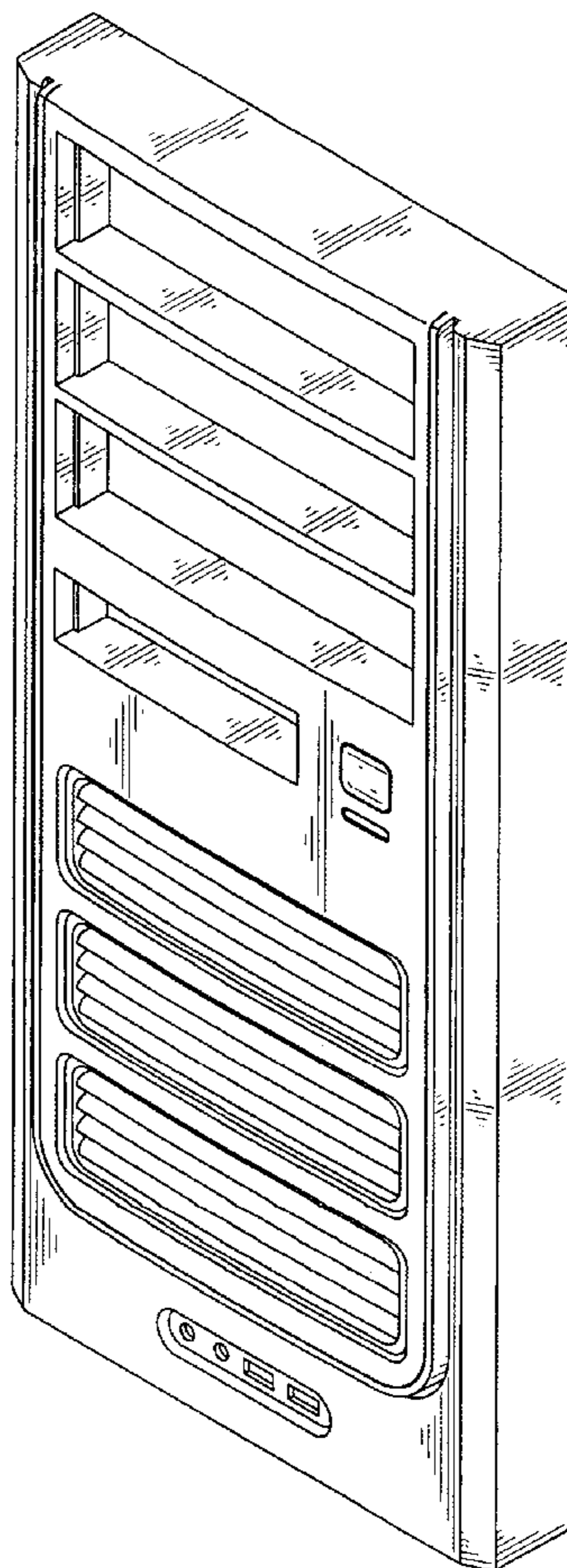

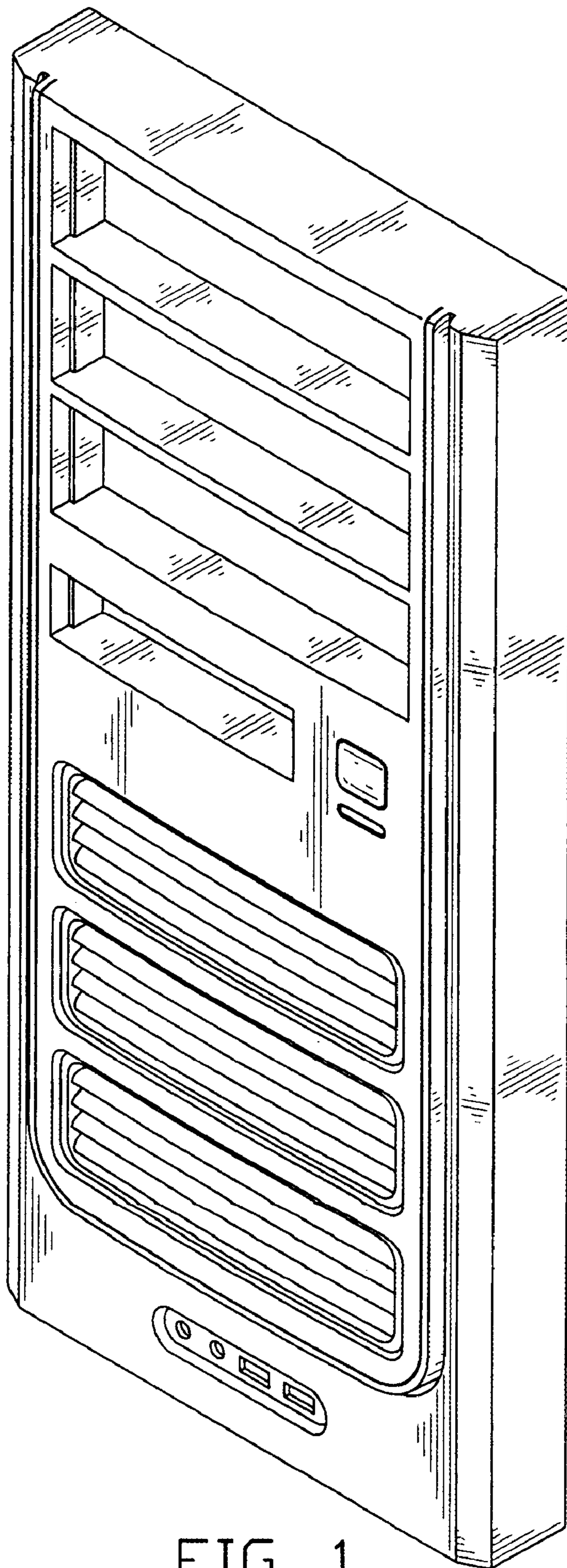

FIG. 1

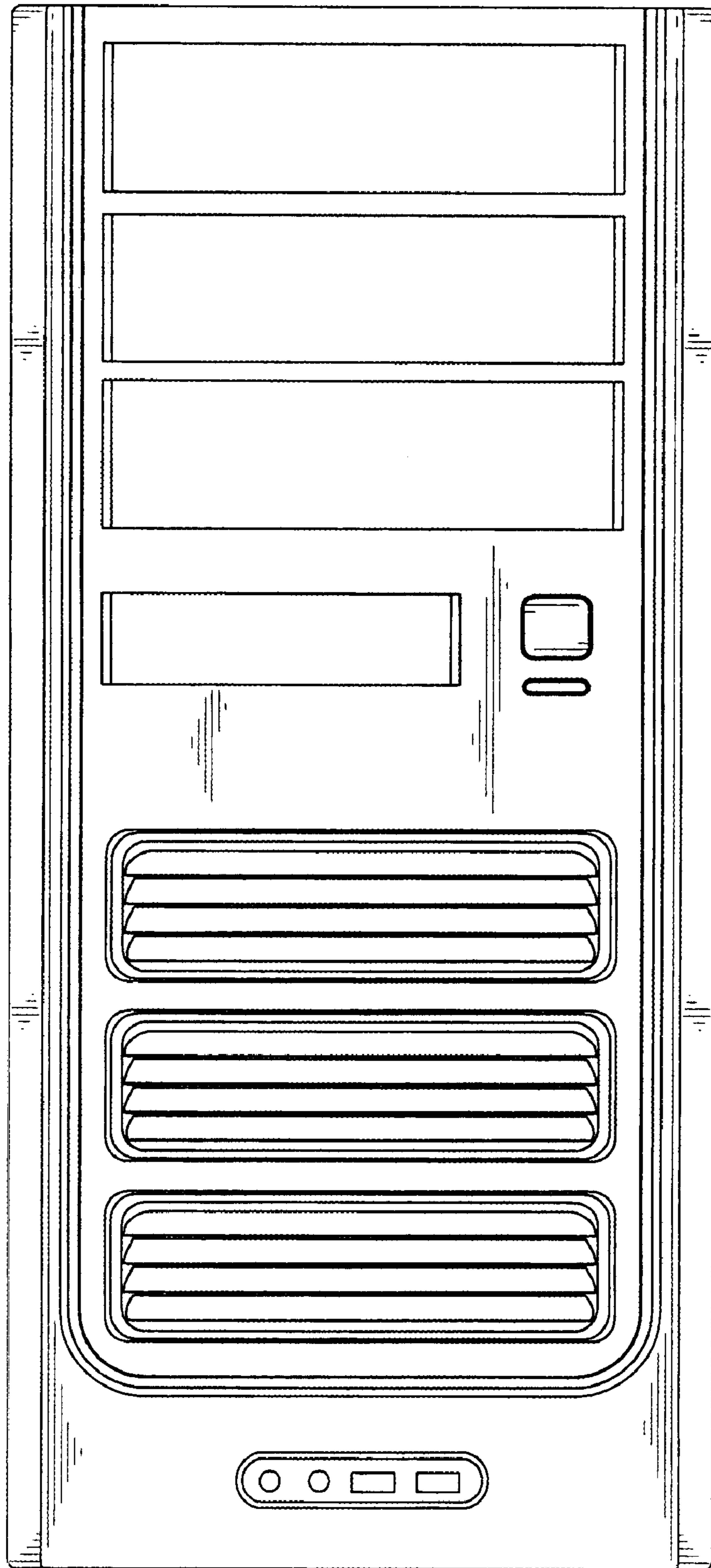

FIG. 2

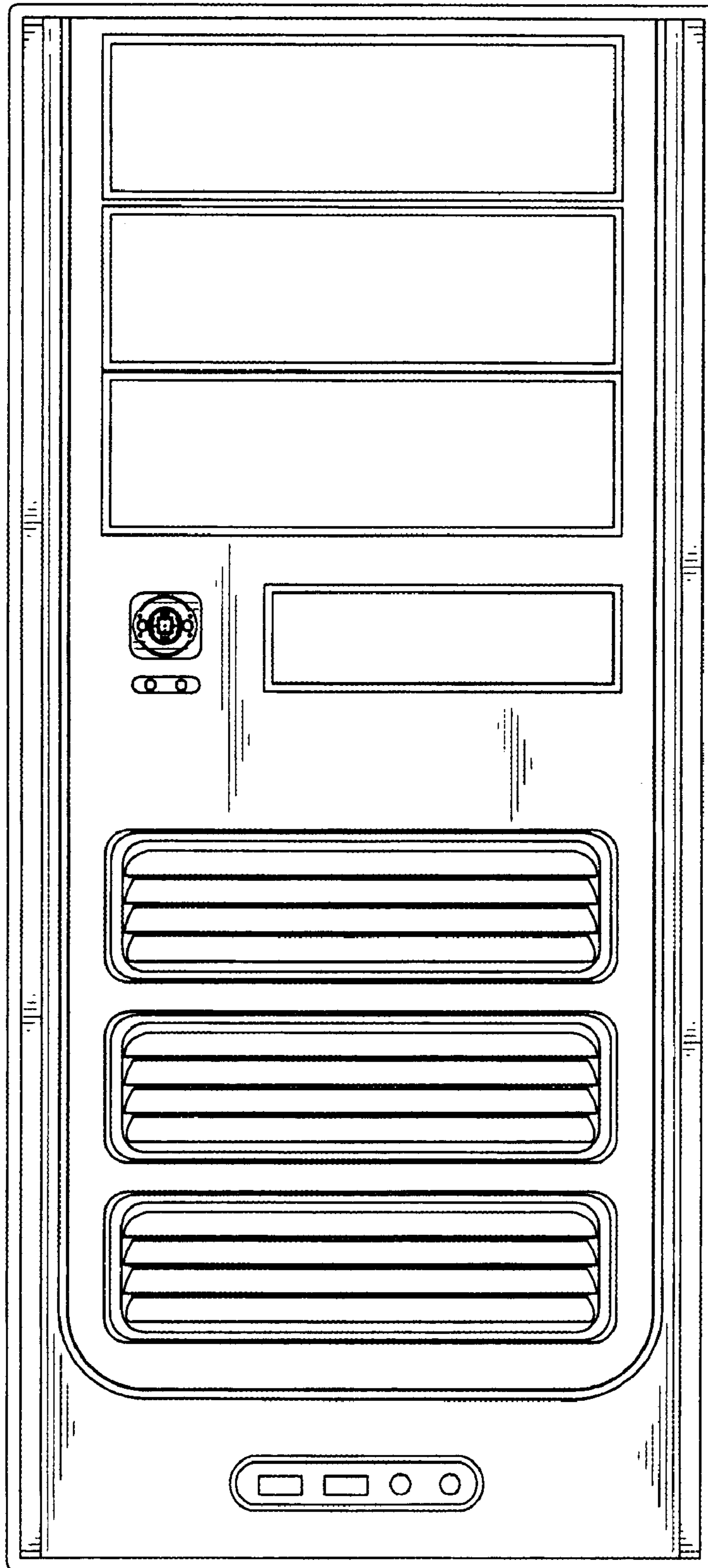

FIG. 3

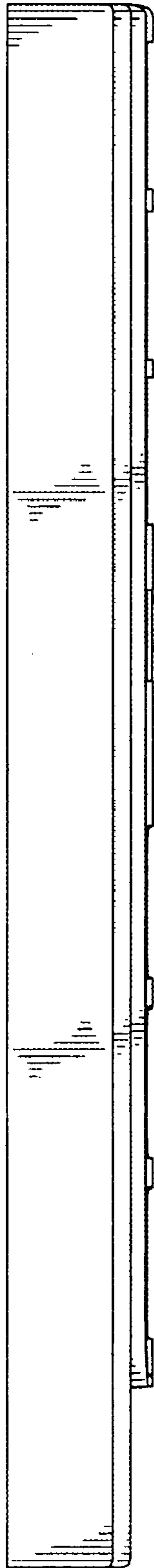

FIG. 4

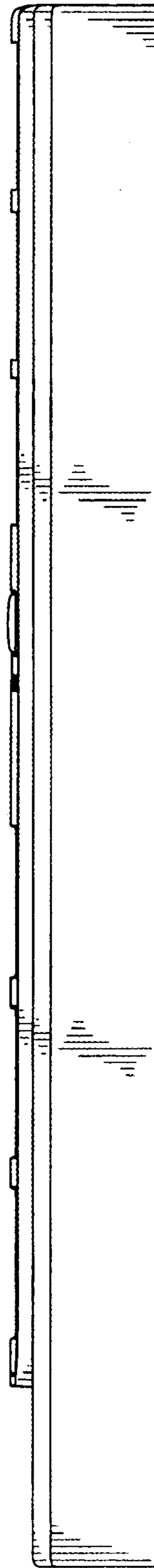

FIG. 5

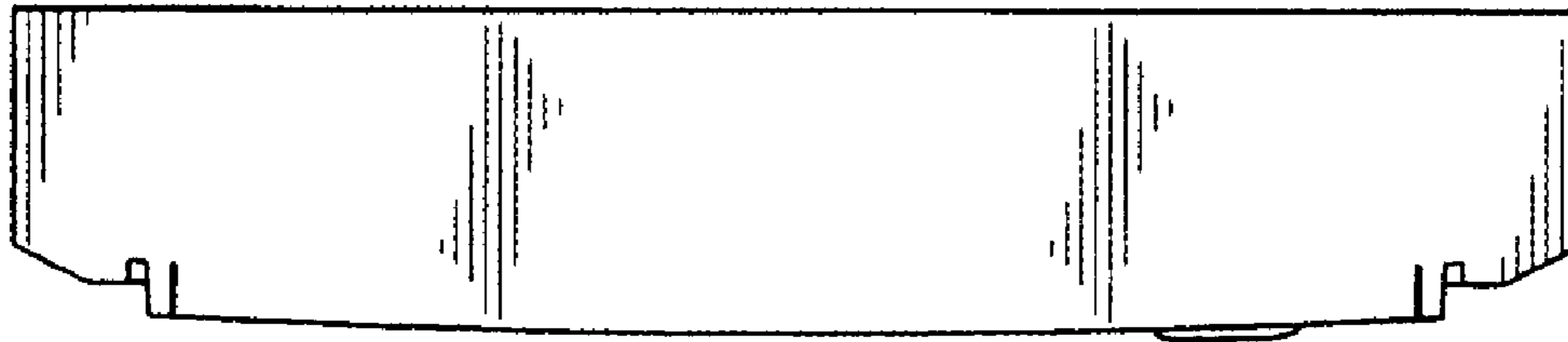

FIG. 6

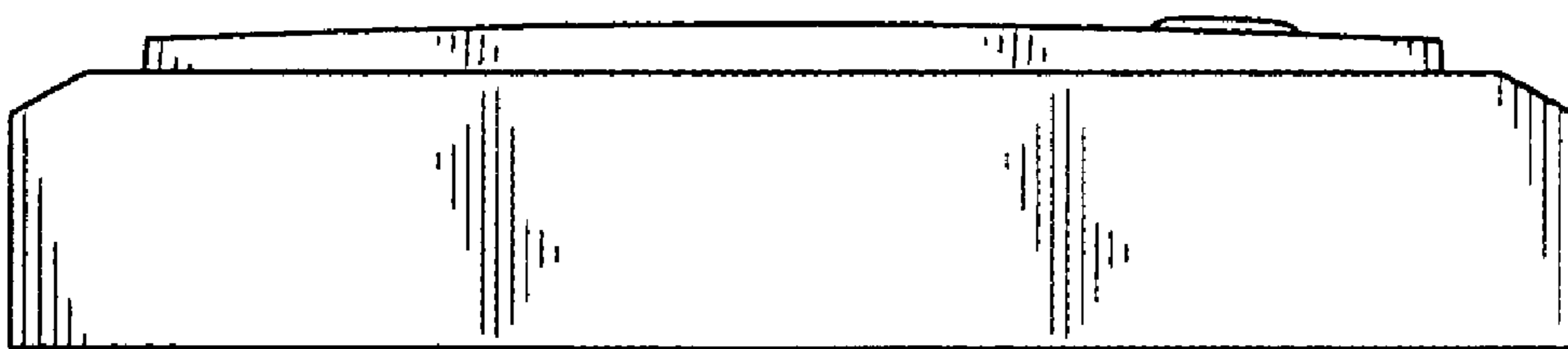

FIG. 7

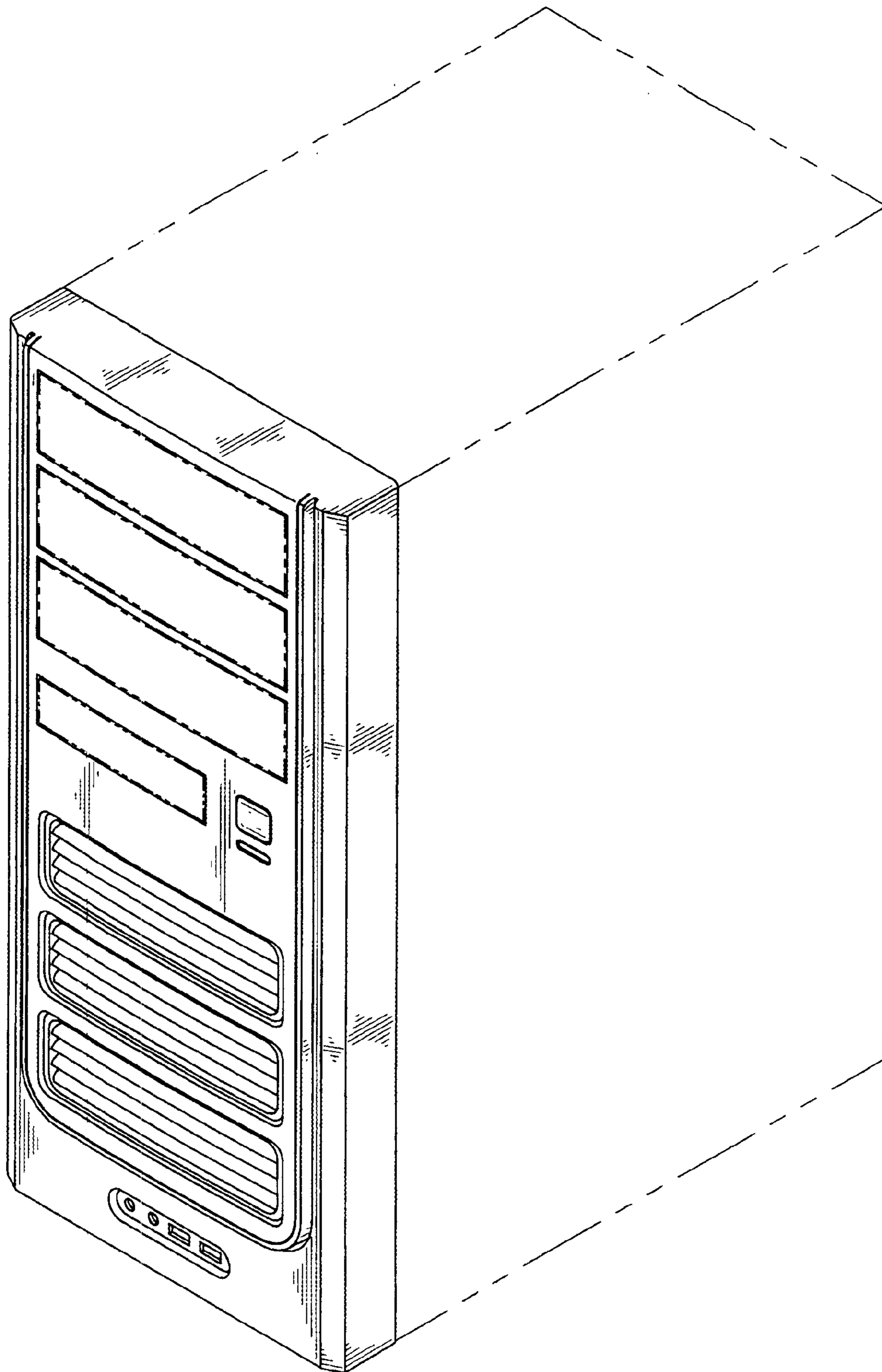

FIG. 8