



US00D534168S

(12) **United States Design Patent**
Wada

(10) **Patent No.:** **US D534,168 S**

(45) **Date of Patent:** **** Dec. 26, 2006**

(54) **MOUSE**

(75) Inventor: **Jo Wada**, Tokyo (JP)

(73) Assignee: **Sony Corporation**, Tokyo (JP)

(**) Term: **14 Years**

(21) Appl. No.: **29/251,400**

(22) Filed: **Jan. 9, 2006**

(51) **LOC (8) Cl.** **14-02**

(52) **U.S. Cl.** **D14/407**

(58) **Field of Classification Search** D14/402-410,
D14/417; 235/472.01; 345/156-167; 365/49;
463/36-38; 200/5 A, 5 R, 6 A, 6 R; 273/148 B
See application file for complete search history.

(56) **References Cited**

U.S. PATENT DOCUMENTS

D284,284 S	*	6/1986	Manock et al.	D14/407
D301,142 S	*	5/1989	Chu	D14/407
D305,331 S	*	1/1990	Esslinger	D14/407
D313,981 S	*	1/1991	Yang	D14/410
D340,923 S	*	11/1993	Tso	D14/407
5,581,277 A	*	12/1996	Tajiri	345/163
D380,463 S	*	7/1997	Wu	D14/407
D386,163 S	*	11/1997	Cheng	D14/407
D460,071 S	*	7/2002	Sheehan et al.	D14/402

D464,350 S	*	10/2002	Kerestegian et al.	D14/402
D483,764 S		12/2003	Masamitsu et al.		
D484,882 S	*	1/2004	Wu	D14/407
D505,956 S		6/2005	Mouri		

FOREIGN PATENT DOCUMENTS

JP	D1153528 S	9/2002
JP	D1223732 S	11/2004
JP	D1223733 S	11/2004

* cited by examiner

Primary Examiner—Pamela J. Burgess

(74) *Attorney, Agent, or Firm*—Rader, Fishman & Grauer PLLC

(57) **CLAIM**

The ornamental design for a mouse, as shown.

DESCRIPTION

FIG. 1 is a perspective view of a mouse showing my new design;

FIG. 2 is a front elevational view thereof;

FIG. 3 is a rear elevational view thereof;

FIG. 4 is a left side elevational view thereof;

FIG. 5 is a right side elevational view thereof;

FIG. 6 is a top plan view thereof; and,

FIG. 7 is a bottom plan view thereof.

1 Claim, 7 Drawing Sheets

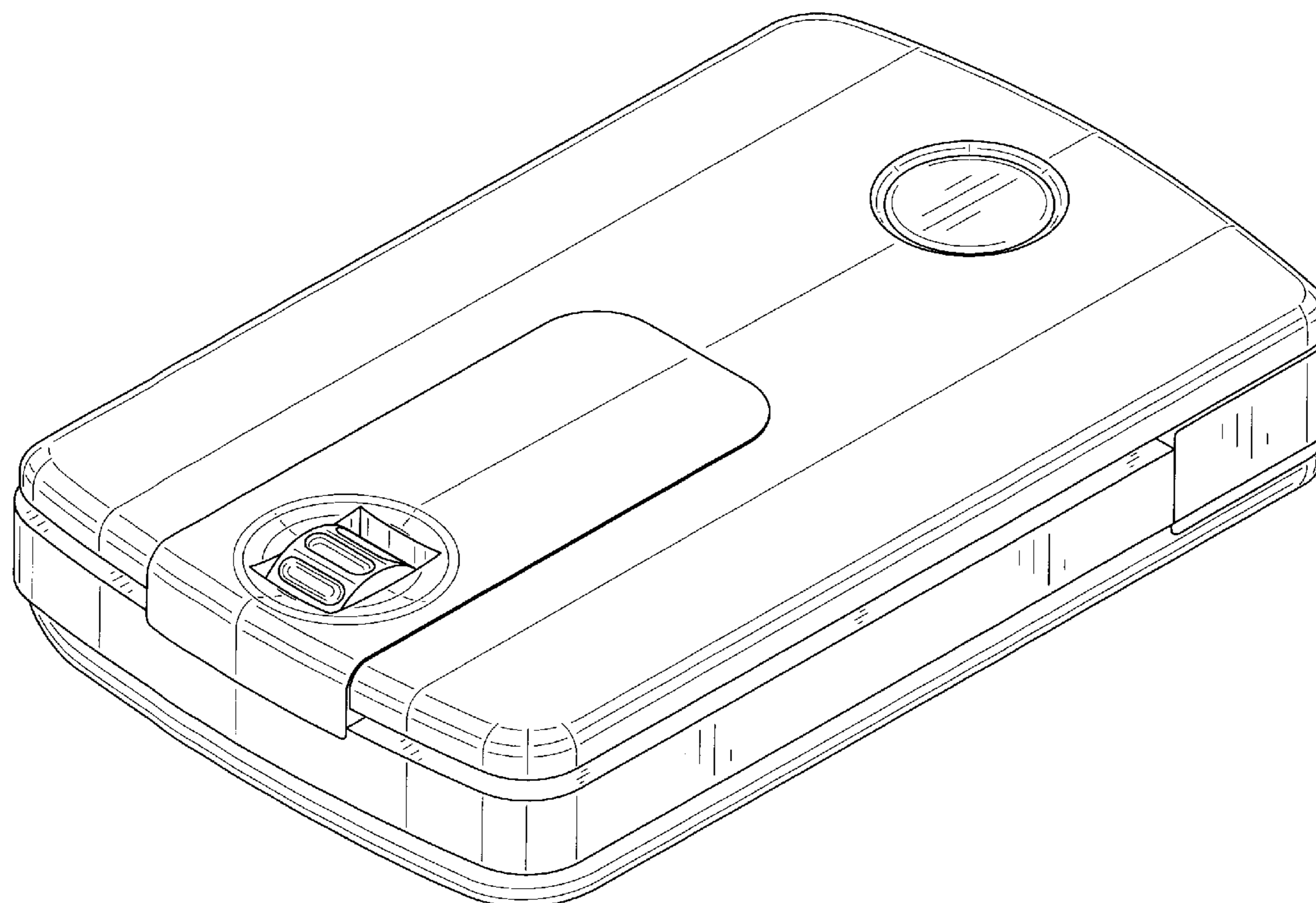

Fig. 1

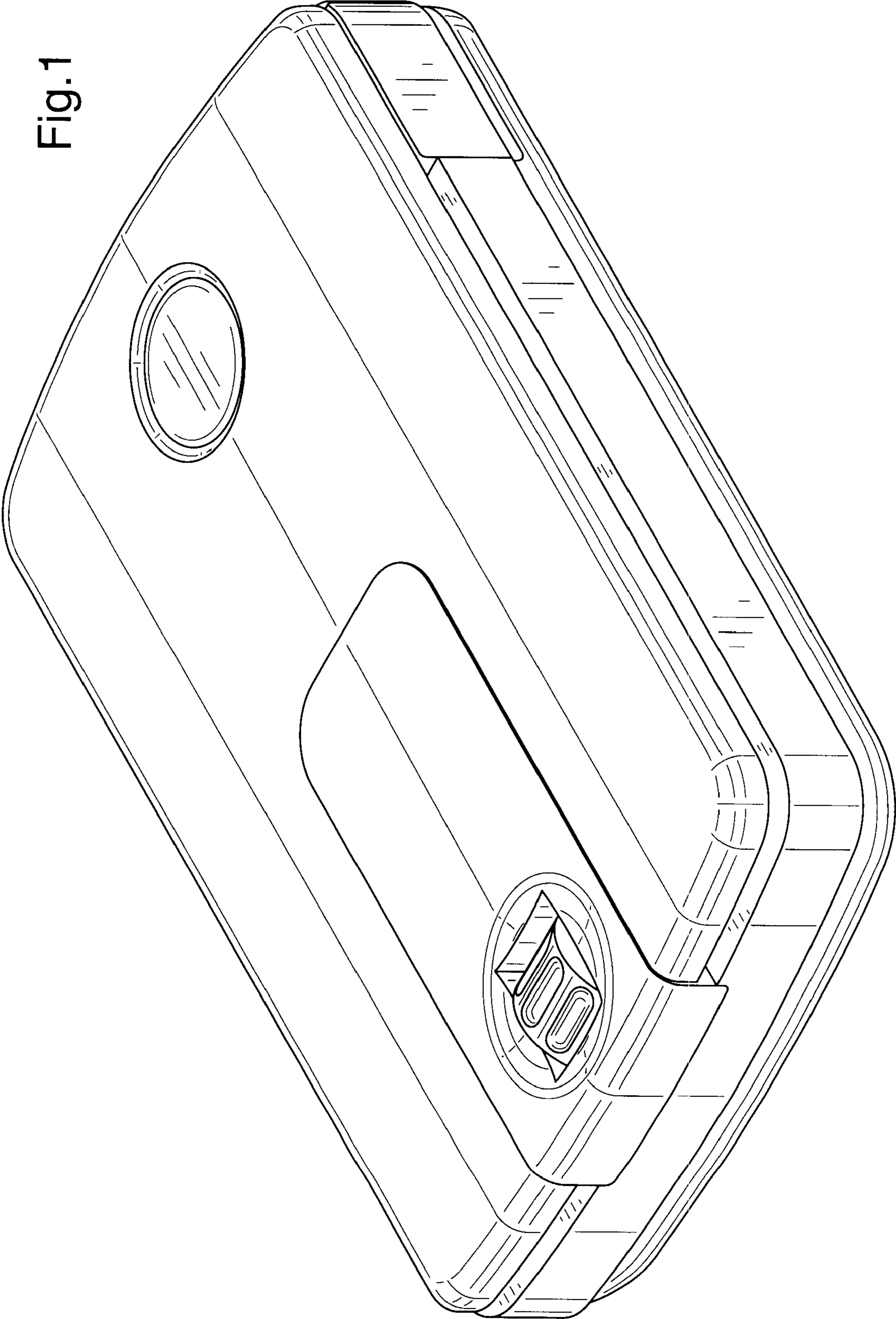

Fig.2

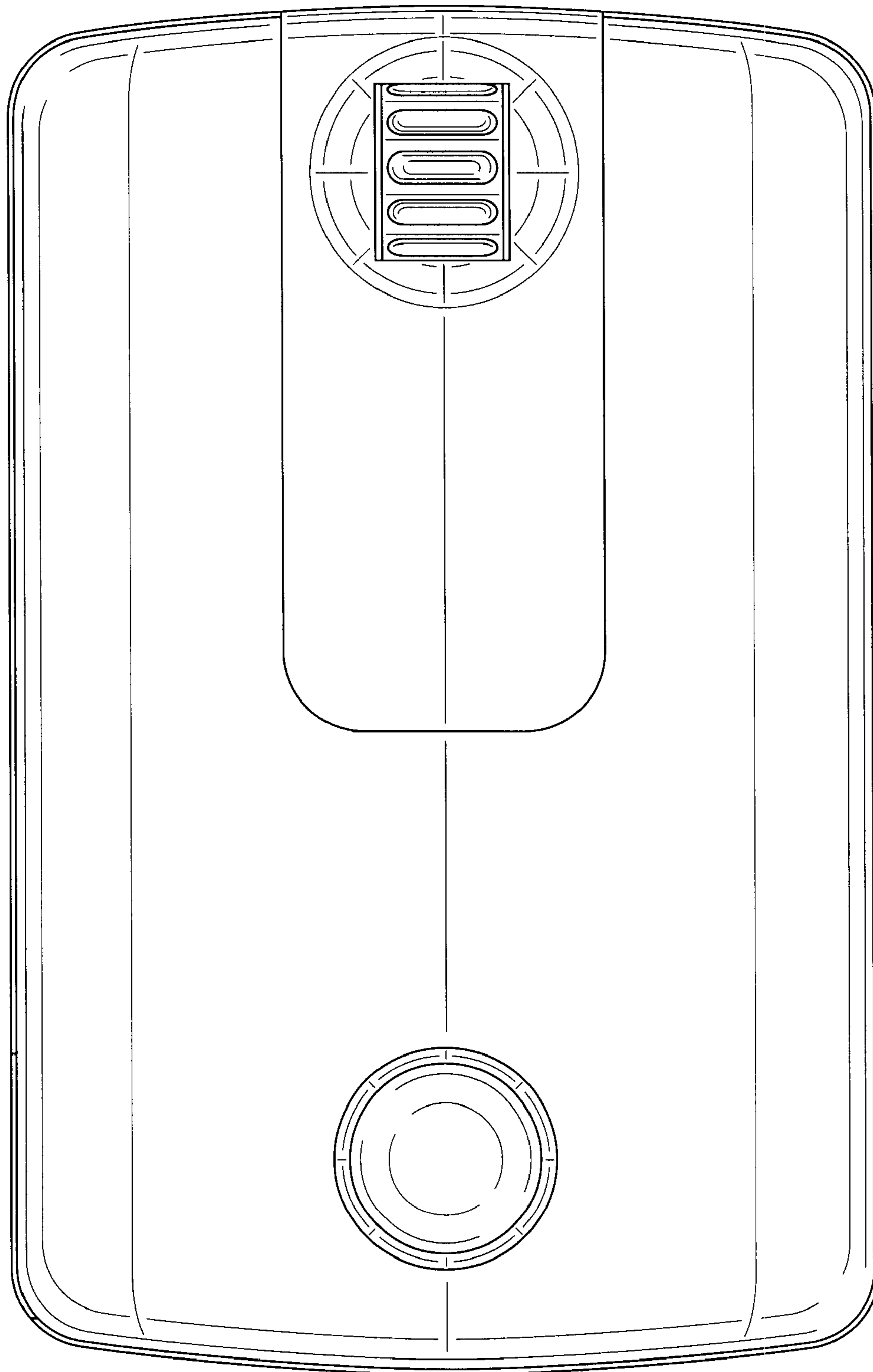

Fig.3

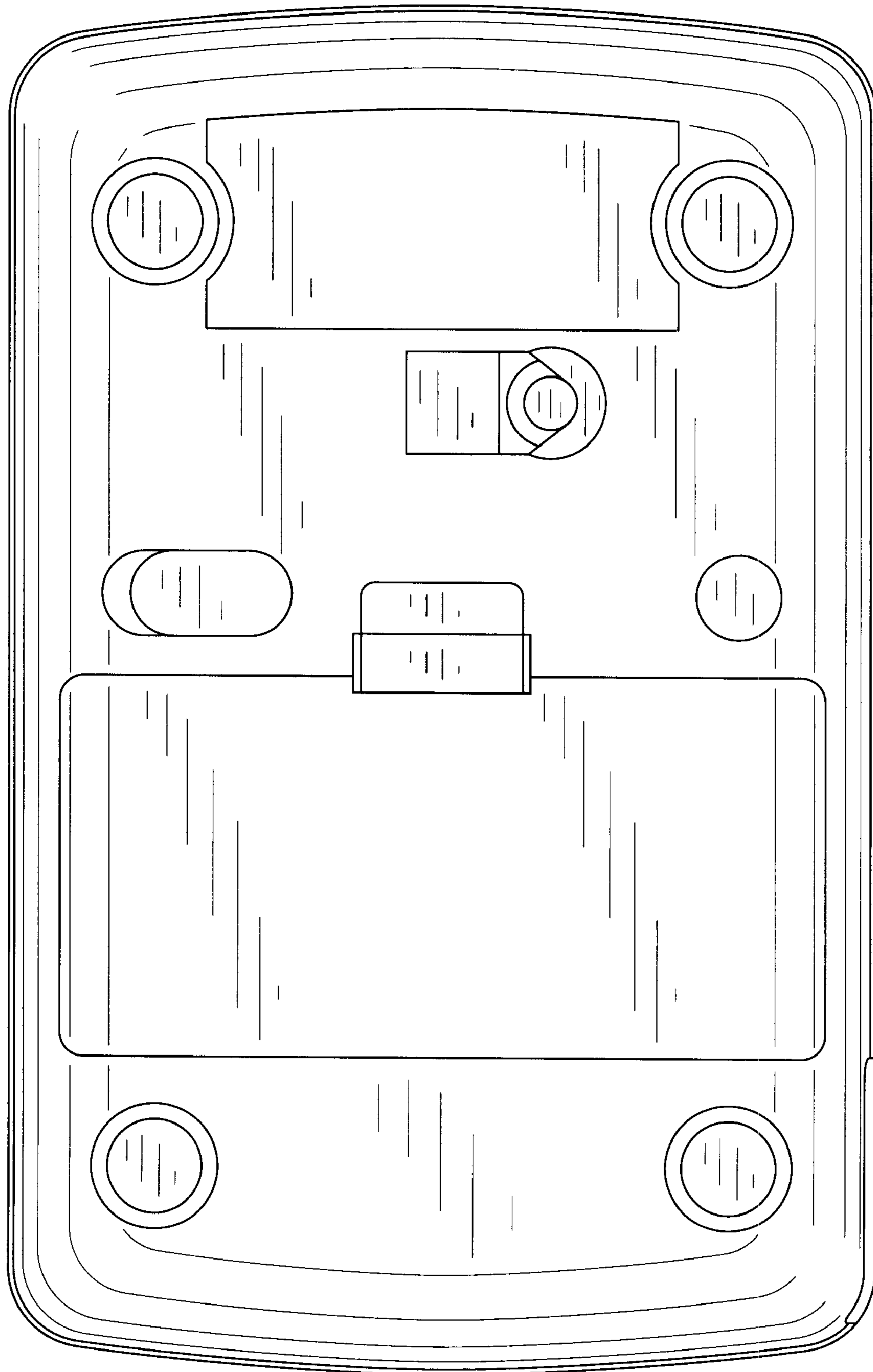

Fig.4

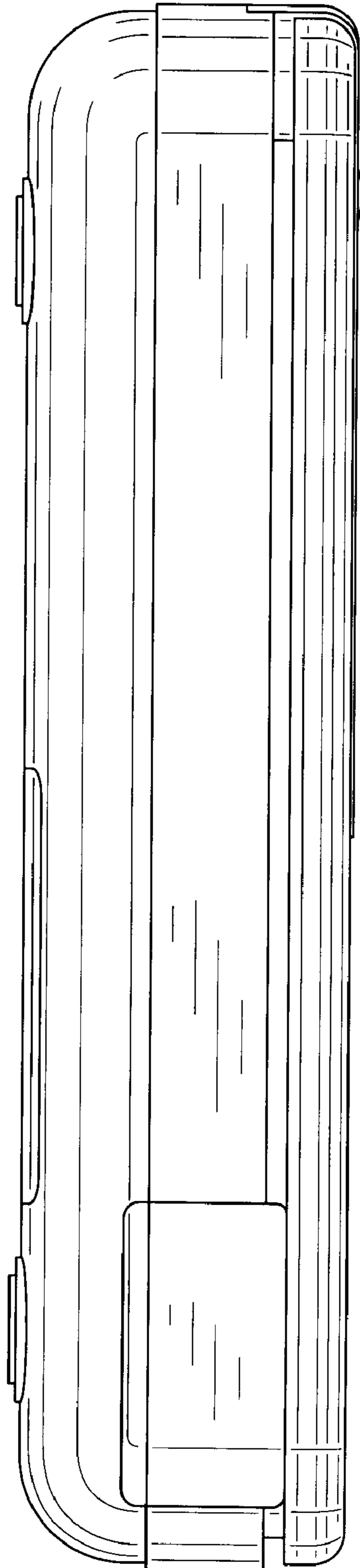

Fig.5

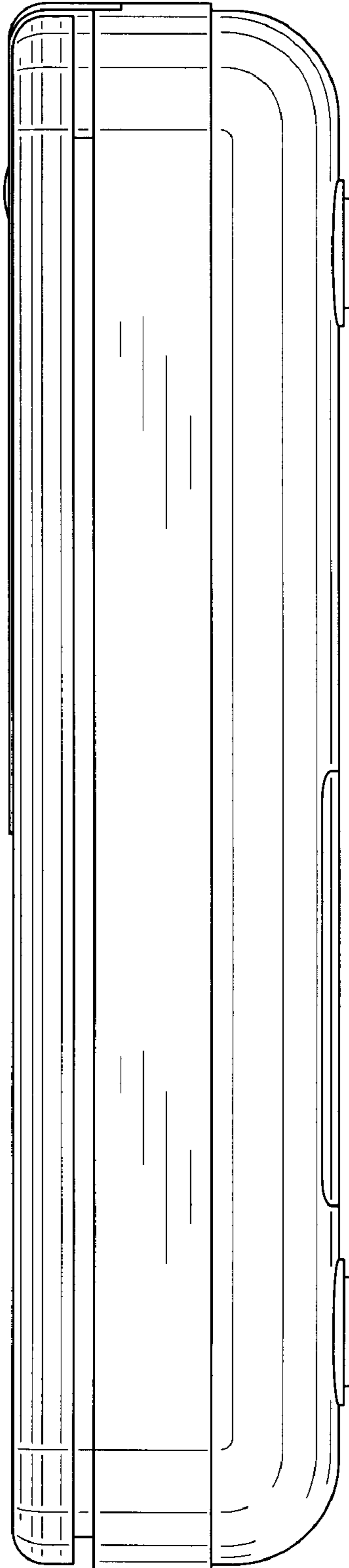

Fig.6

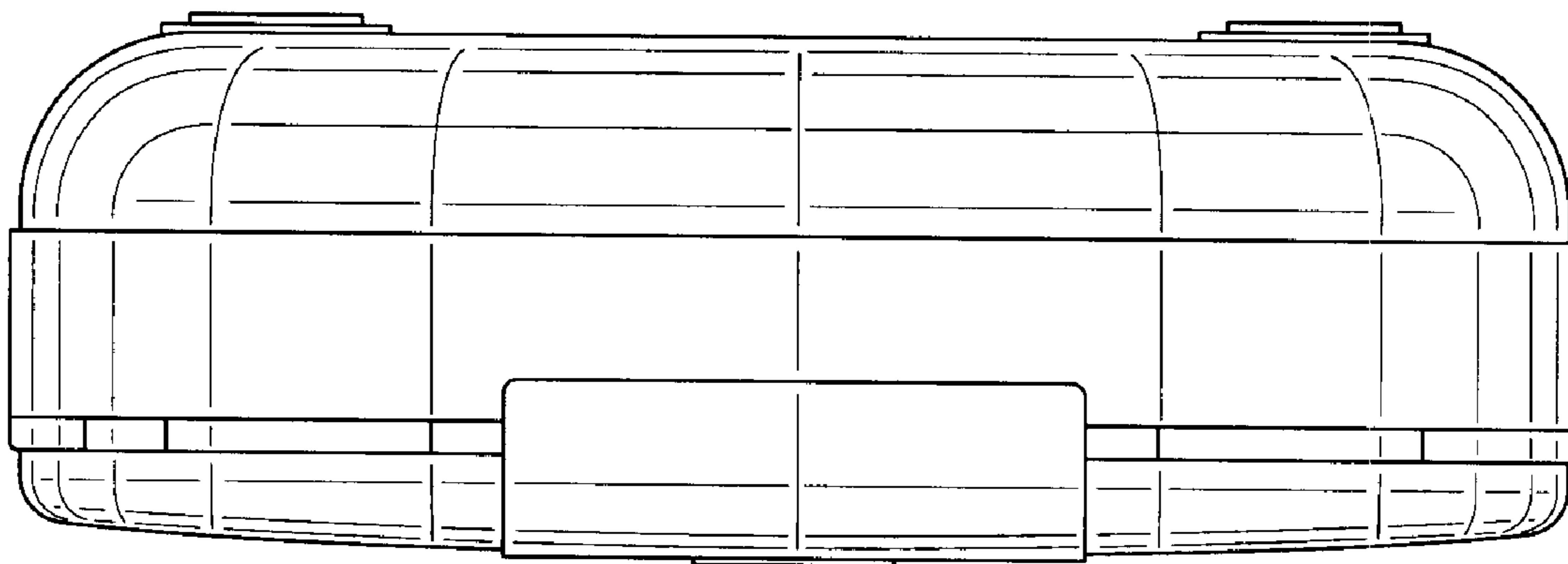

Fig.7

