

US00D534151S

(12) **United States Design Patent**
Marquez

(10) **Patent No.:** **US D534,151 S**

(45) **Date of Patent:** **** Dec. 26, 2006**

(54) **INTERPRETERS CONSOLE**

(75) Inventor: **Lacides Marquez**, Re Nuenen (NL)

(73) Assignee: **Robert Bosch GmbH**, Stuttgart (DE)

(**) Term: **14 Years**

(21) Appl. No.: **29/228,785**

(22) Filed: **Apr. 28, 2005**

(30) **Foreign Application Priority Data**

Dec. 30, 2004 (EM) 000275110

(51) **LOC (8) Cl.** **14-01**

(52) **U.S. Cl.** **D14/158; D14/159**

(58) **Field of Classification Search** D14/149,
D14/154-155, 158-159, 226, 229, 240; 379/388.02,
379/419, 420.03, 428.01, 440; 455/90
See application file for complete search history.

(56) **References Cited**

U.S. PATENT DOCUMENTS

D349,286 S * 8/1994 Robertus D14/159

D371,784 S * 7/1996 Gertz D14/226

D429,231 S * 8/2000 Johnsson D14/159

D450,308 S * 11/2001 Benders D14/226

D494,152 S * 8/2004 Sabick et al. D14/149

* cited by examiner

Primary Examiner—Nanda Bondade

(74) *Attorney, Agent, or Firm*—Michael J. Striker

(57) **CLAIM**

I claim the ornamental design for an interpreters console, as shown and described.

DESCRIPTION

FIG. 1 is a top perspective view of a interpreters console showing my new design;

FIG. 2 is a rear view thereof;

FIG. 3 is a front view thereof;

FIG. 4 is a top view thereof;

FIG. 5 is a bottom view thereof;

FIG. 6 is a right side elevational view thereof; and,

FIG. 7 is a left side elevational view thereof.

1 Claim, 7 Drawing Sheets

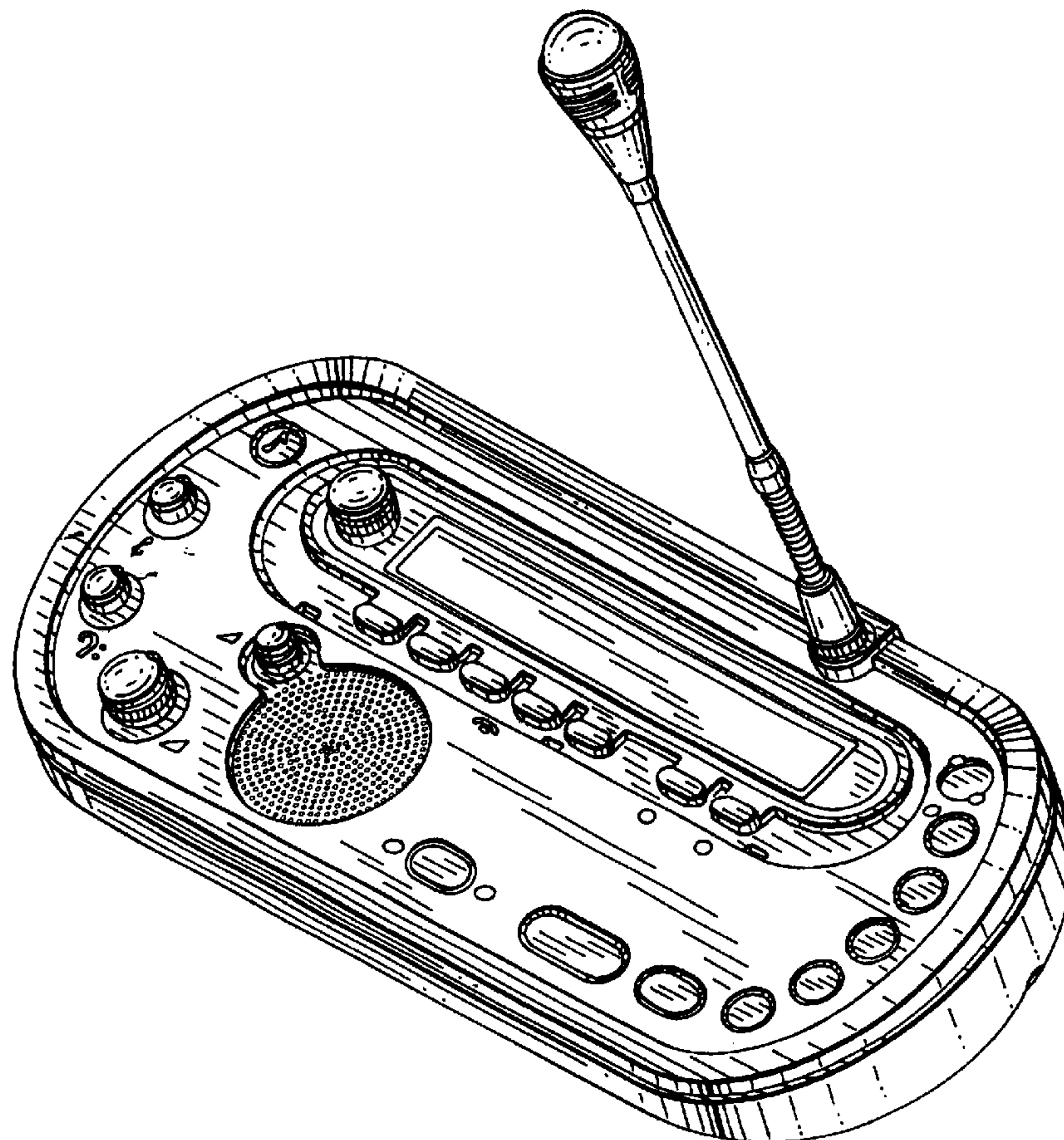

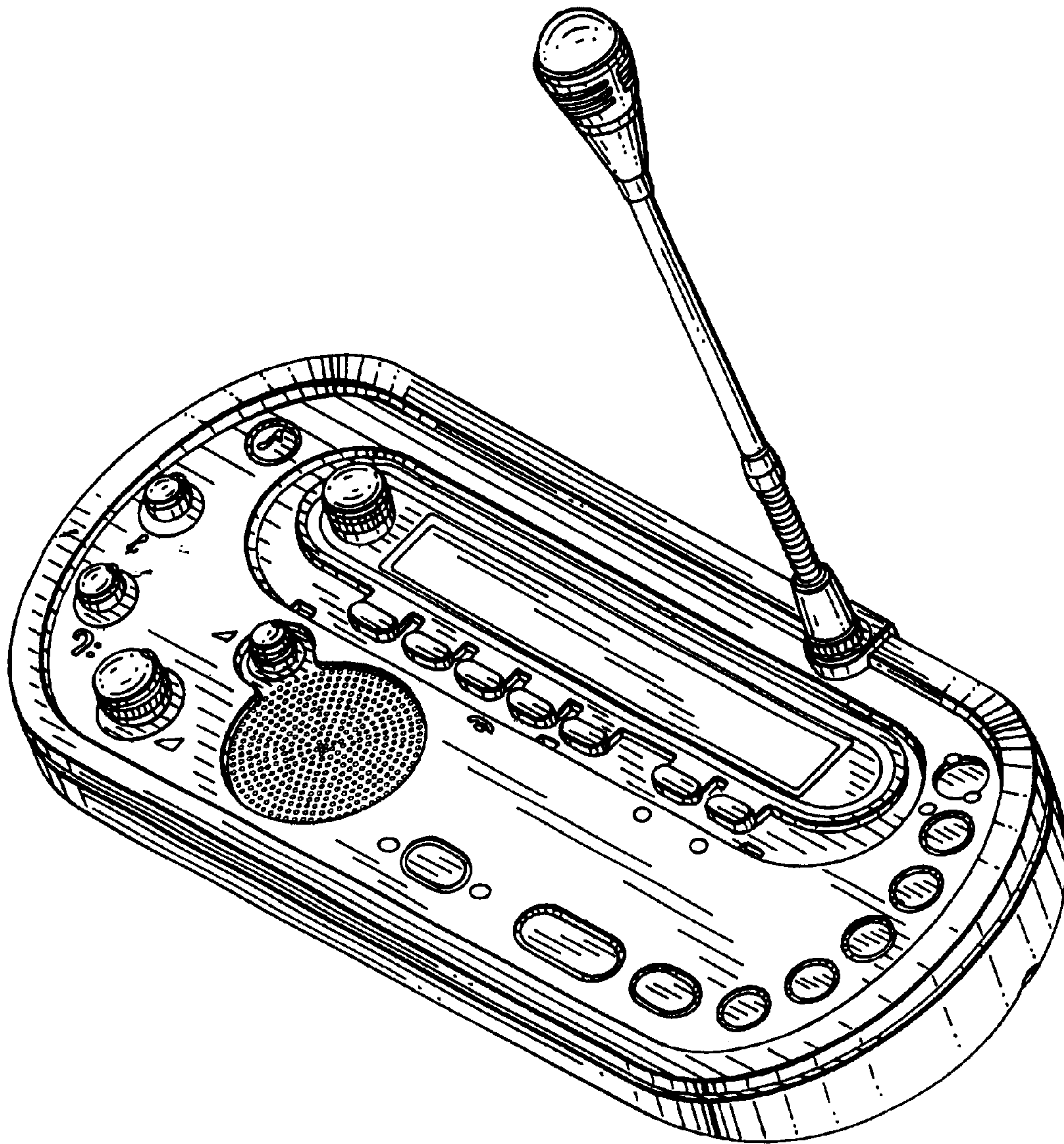

FIG. 1

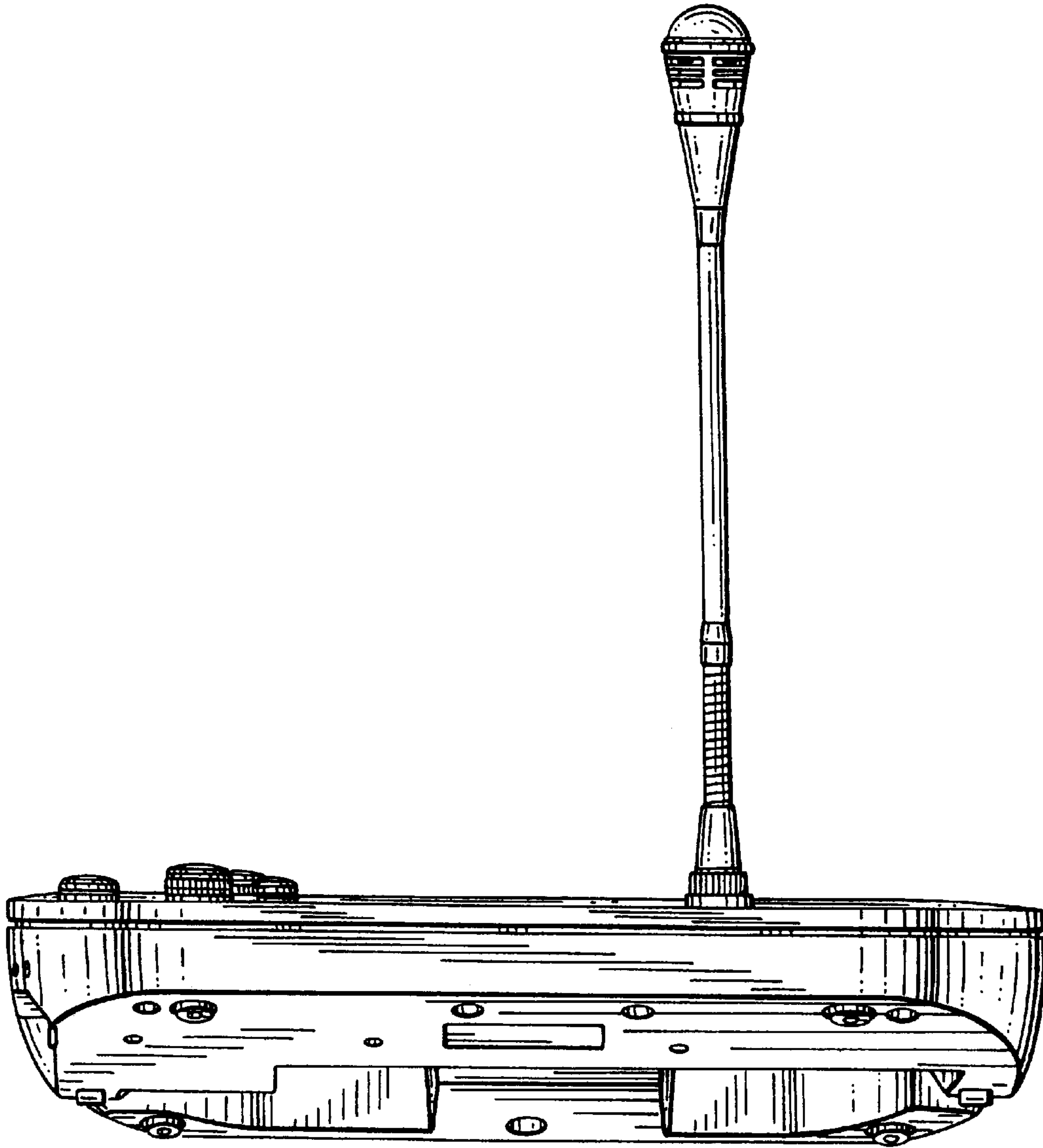

FIG. 2

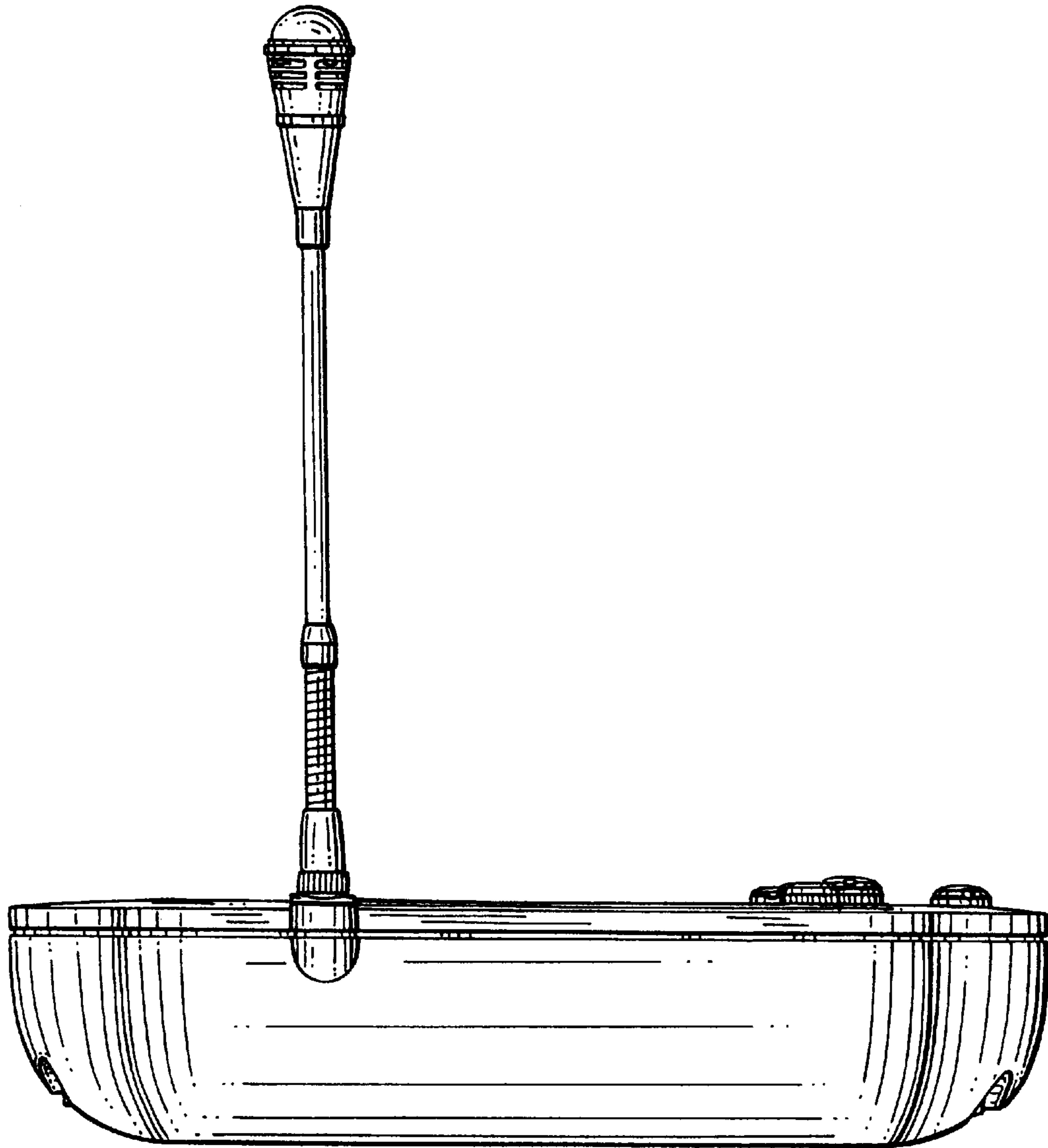

FIG. 3

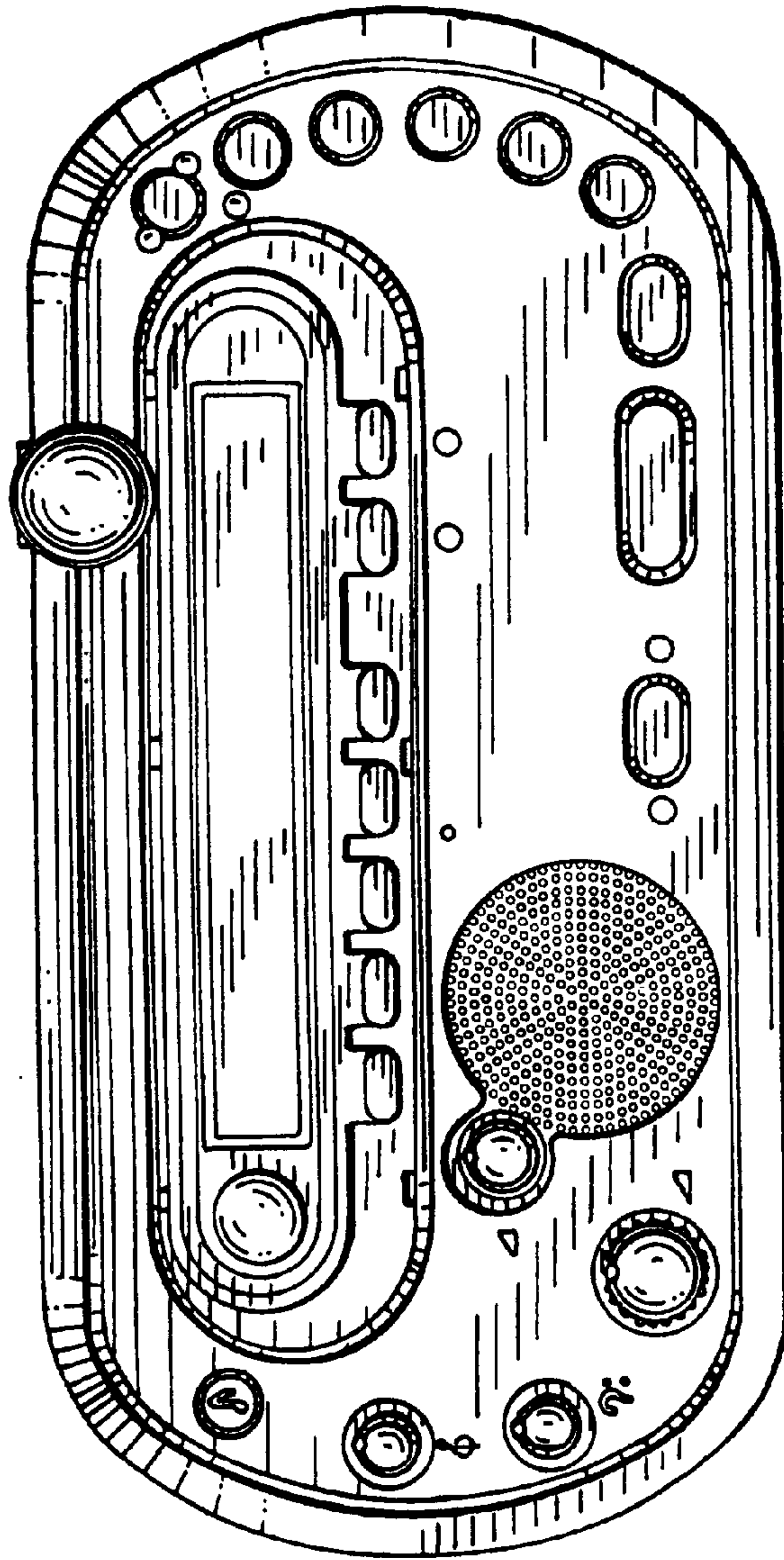

FIG. 4

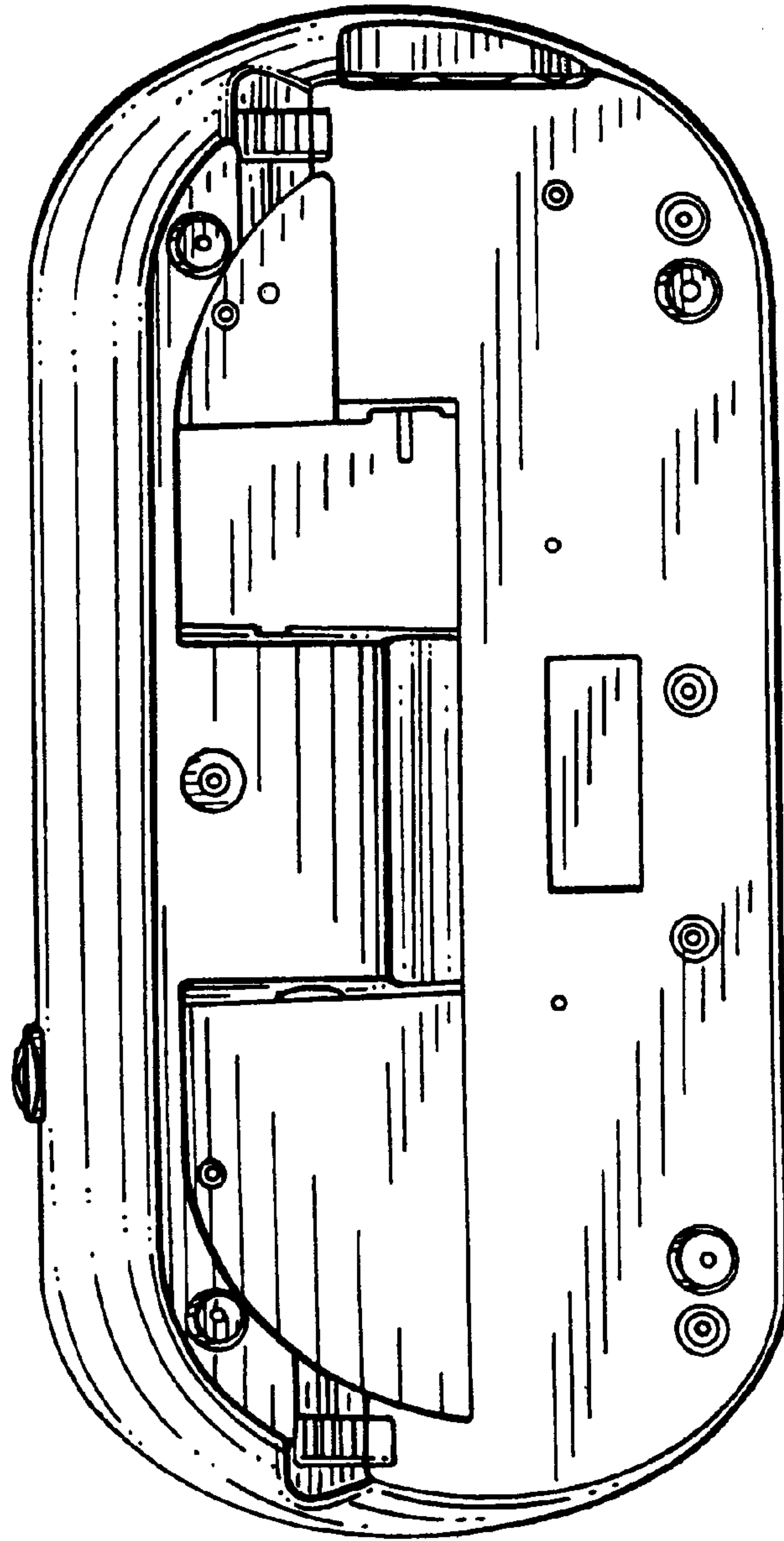

FIG. 5

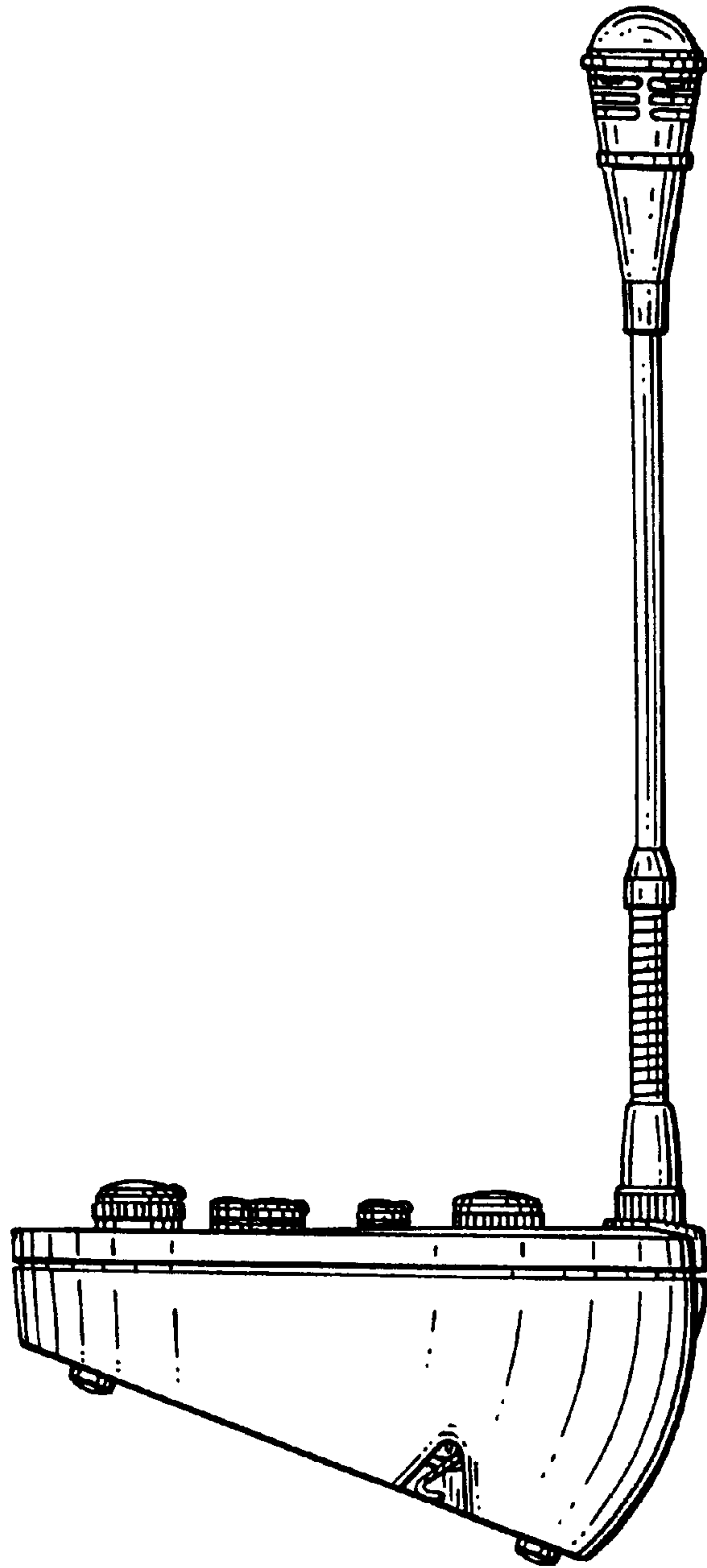

FIG. 6

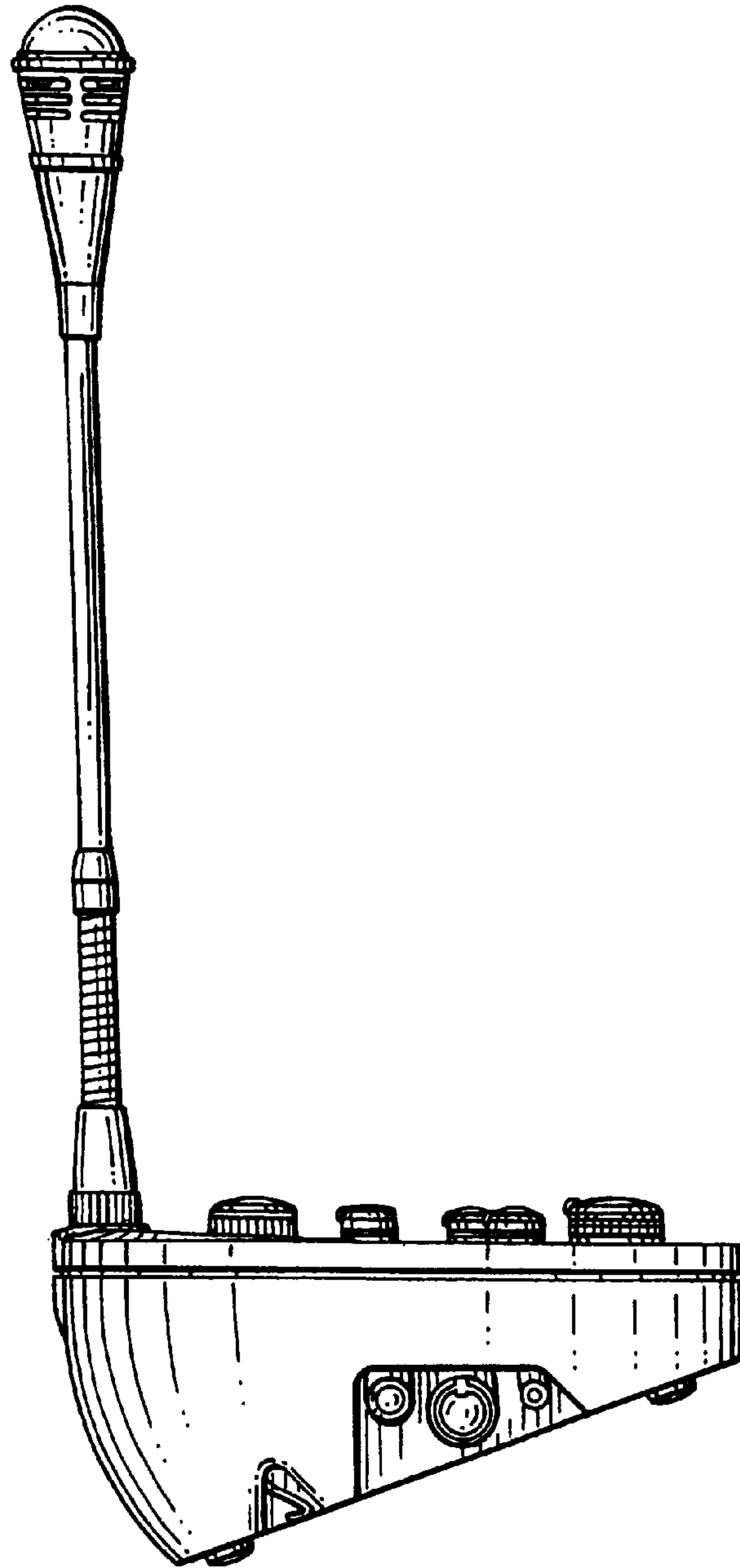

FIG. 7