



US00D534071S

(12) **United States Design Patent**
Hoff

(10) **Patent No.:** **US D534,071 S**

(45) **Date of Patent:** **** Dec. 26, 2006**

(54) **PACKAGE**

(75) **Inventor:** **Petrus Mattheus Maria Hoff,**
Roosendaal (NL)

(73) **Assignee:** **Holding P.M.M. Hoff B.V.,** Roosendahl
(NL)

(**) **Term:** **14 Years**

(21) **Appl. No.:** **29/241,865**

(22) **Filed:** **Nov. 1, 2005**

(30) **Foreign Application Priority Data**

Jun. 10, 2005 (EM) 000353792

(51) **LOC (8) Cl.** **09-03**

(52) **U.S. Cl.** **D9/430**

(58) **Field of Classification Search** D9/414,
D9/416, 423, 425, 427, 430-433; 229/116.1,
229/117, 100, 125.19, 137, 138, 165, 920,
229/922

See application file for complete search history.

(56) **References Cited**

U.S. PATENT DOCUMENTS

2,050,894 A * 8/1936 Paige 229/116.1
3,076,589 A * 2/1963 Medijam 229/100
D211,564 S * 7/1968 Bailey D9/433

4,313,556 A * 2/1982 Boyle et al. 229/116.1
D394,385 S * 5/1998 Laughlin D9/431
D397,294 S * 8/1998 Saulas D9/430
D436,315 S * 1/2001 Bentolila D9/430

* cited by examiner

Primary Examiner—Stella Reid

Assistant Examiner—Mark Goodwin

(74) *Attorney, Agent, or Firm*—Collen IP; Donald J. Ranft

(57) **CLAIM**

The ornamental design for a package, as shown and described.

DESCRIPTION

FIG. 1 is a front perspective view of my new and ornamental design for a package, in a closed state;

FIG. 2 is a side perspective view thereof, the opposite side perspective view being a mirror image thereof;

FIG. 3 is a front view thereof; the rear view, left side, and right side being a mirror image thereof;

FIG. 4 is a front perspective view thereof in a semi-opened state;

FIG. 5 is a top view thereof in a semi-opened state;

FIG. 6 is a front perspective view thereof in a fully opened state; and,

FIG. 7 is a side perspective view thereof in a closed state.

1 Claim, 2 Drawing Sheets

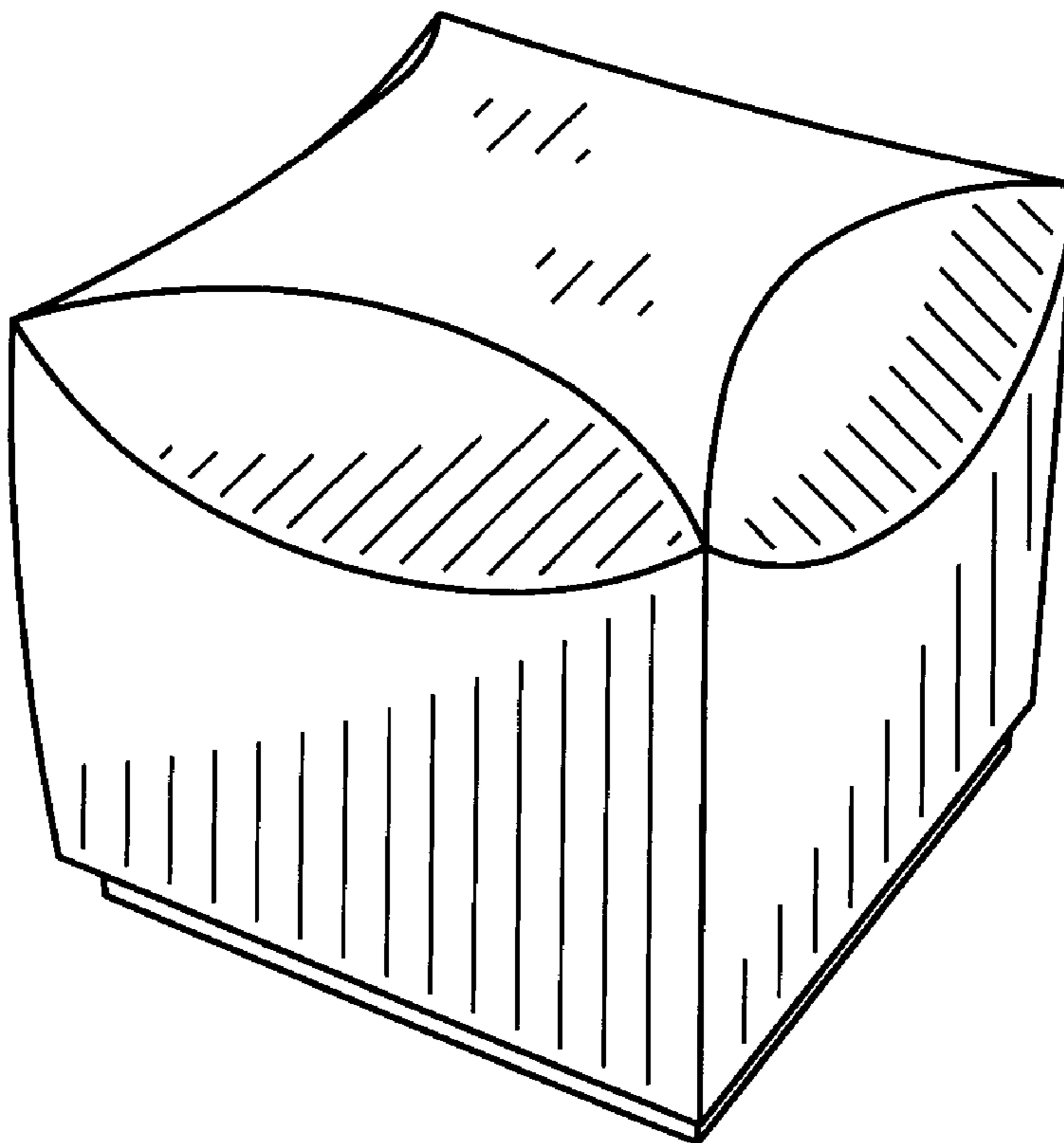

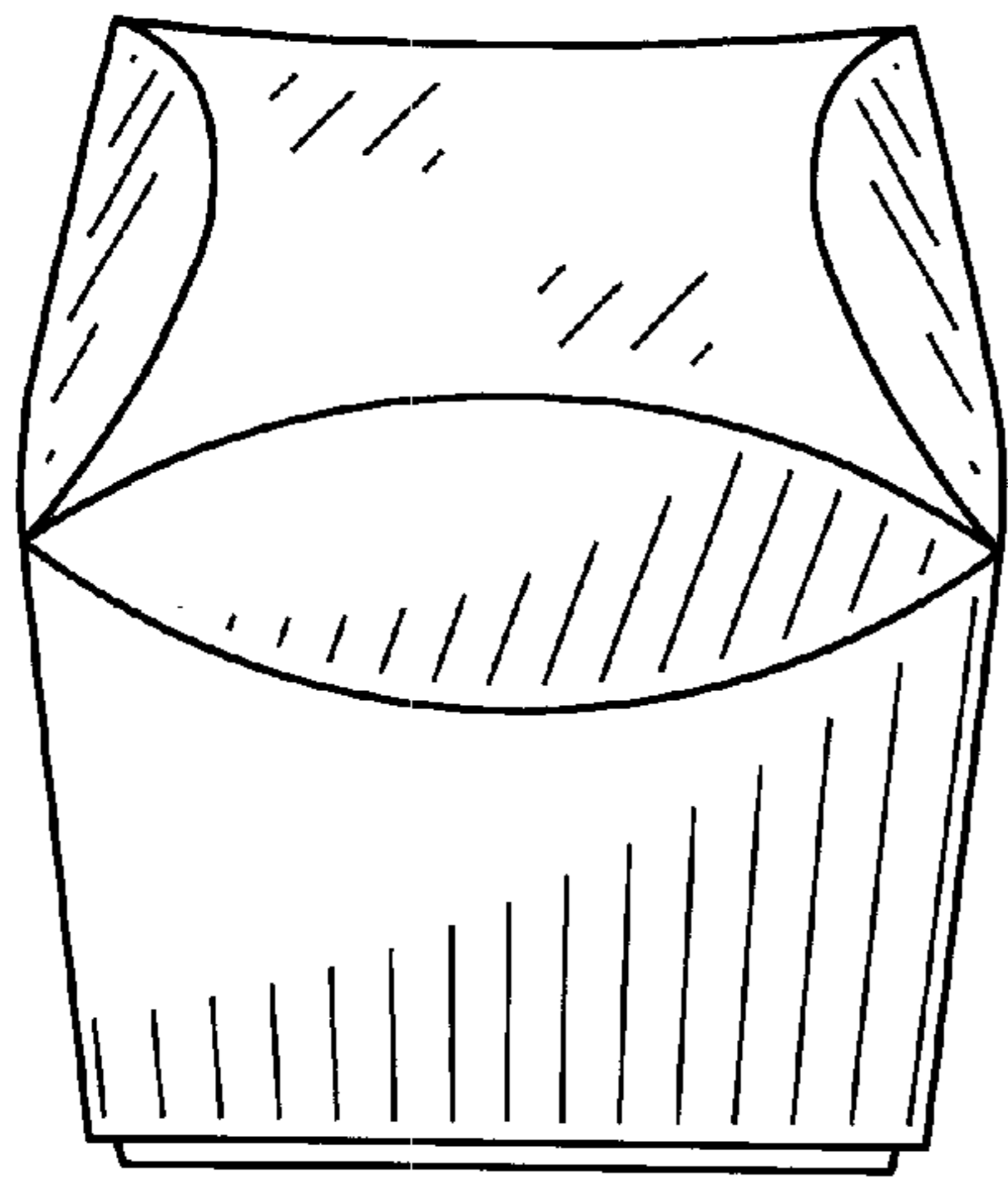

FIG. 1

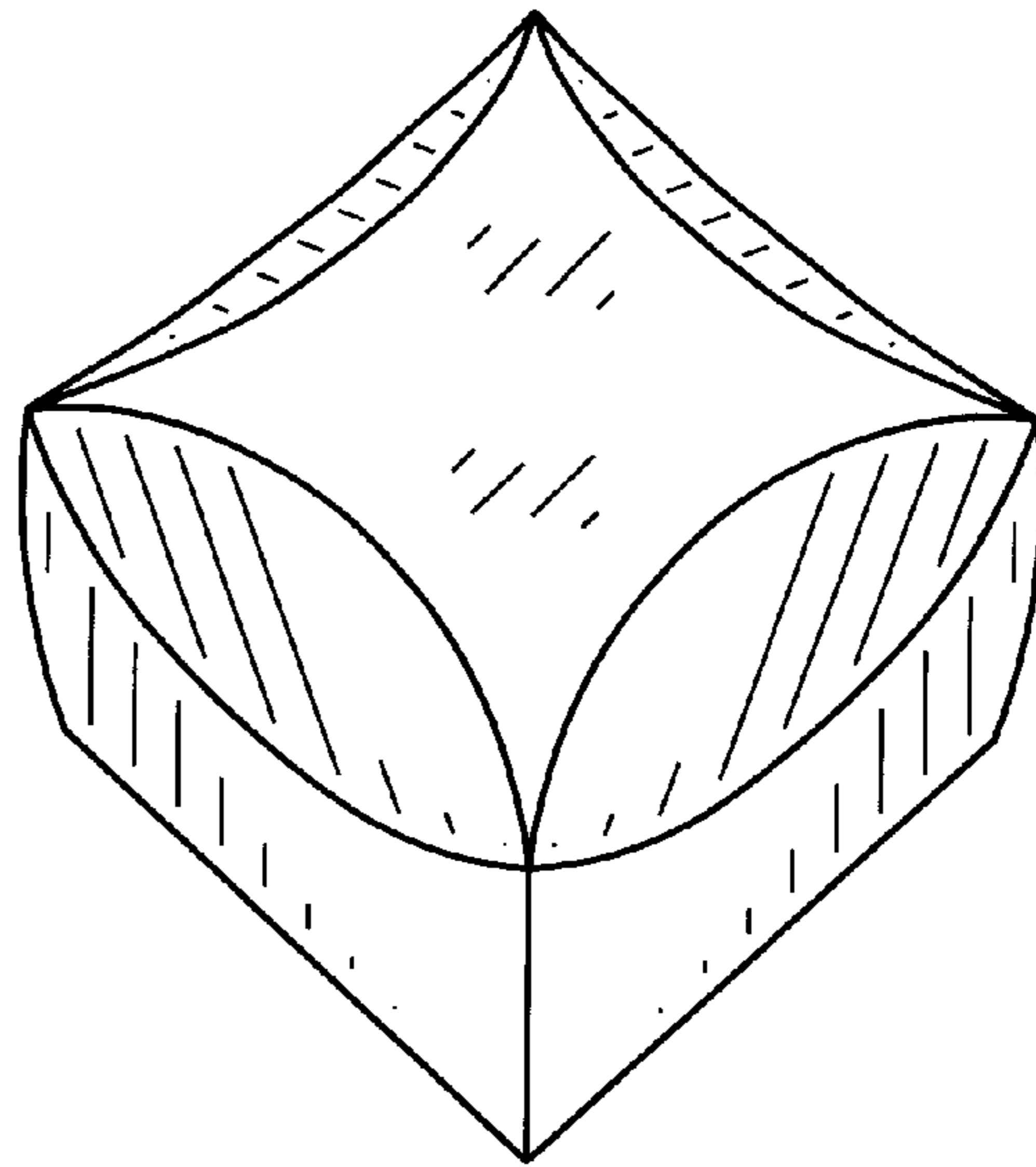

FIG. 2

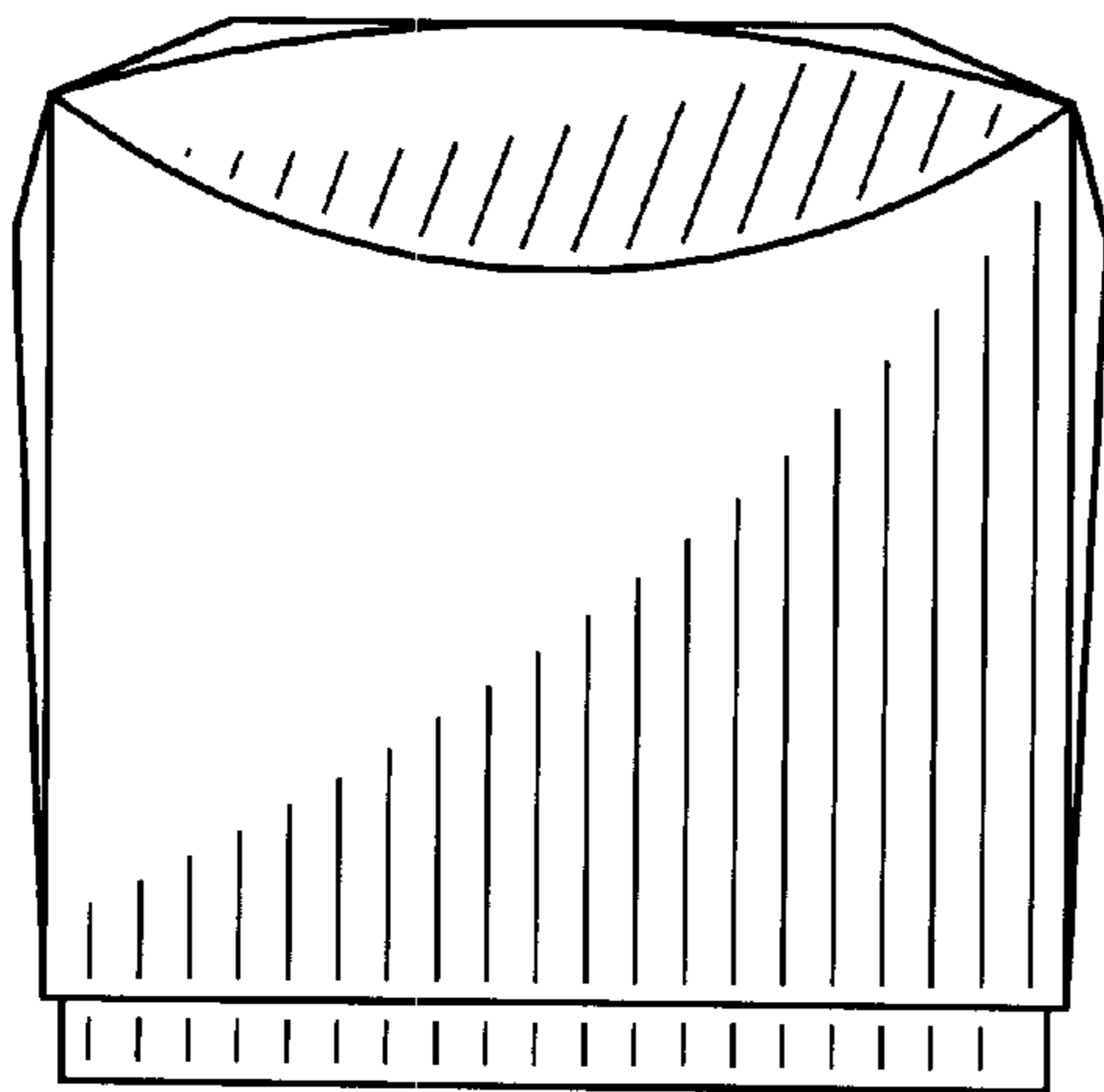

FIG. 3

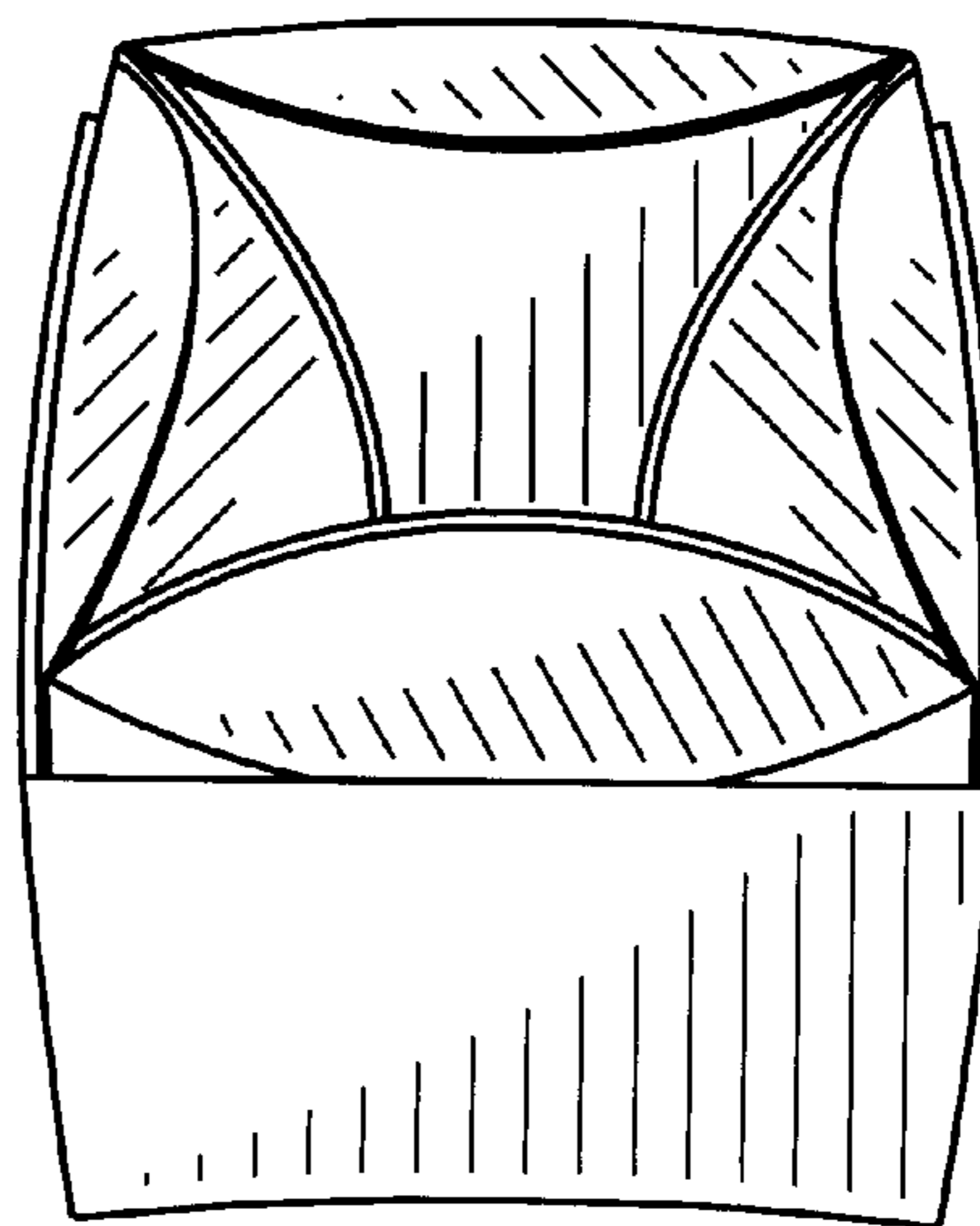

FIG. 4

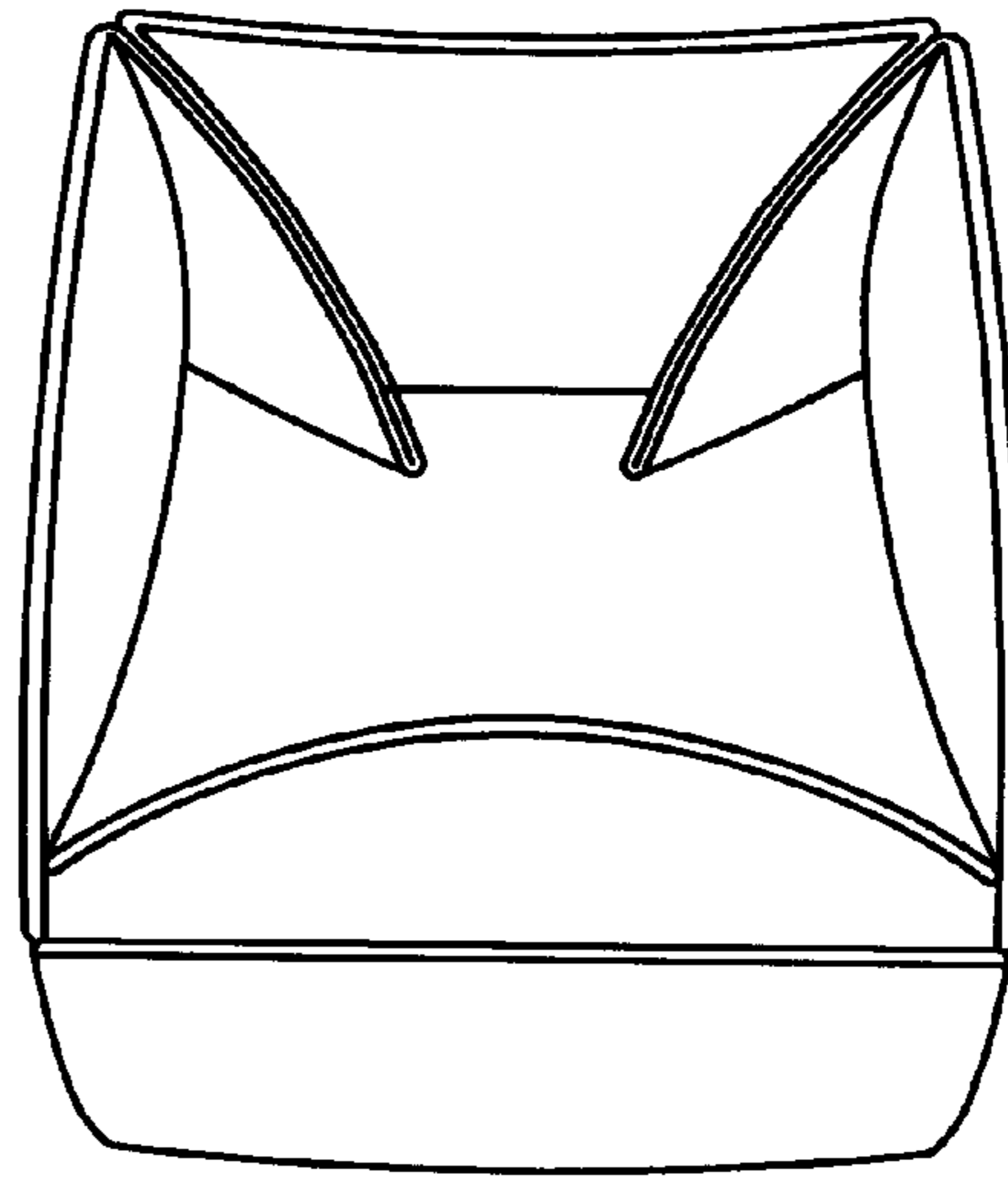

FIG. 5

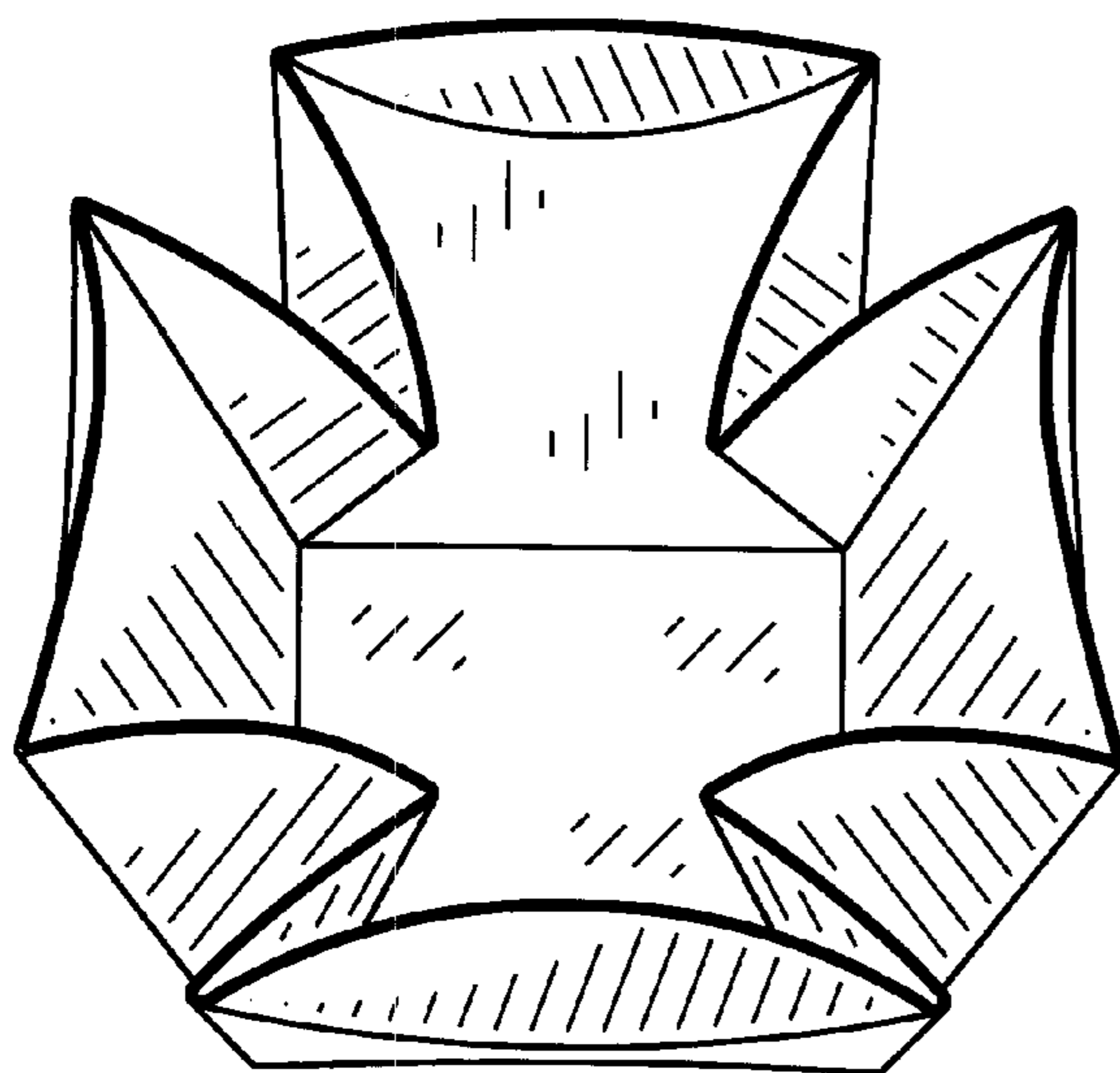

FIG. 6

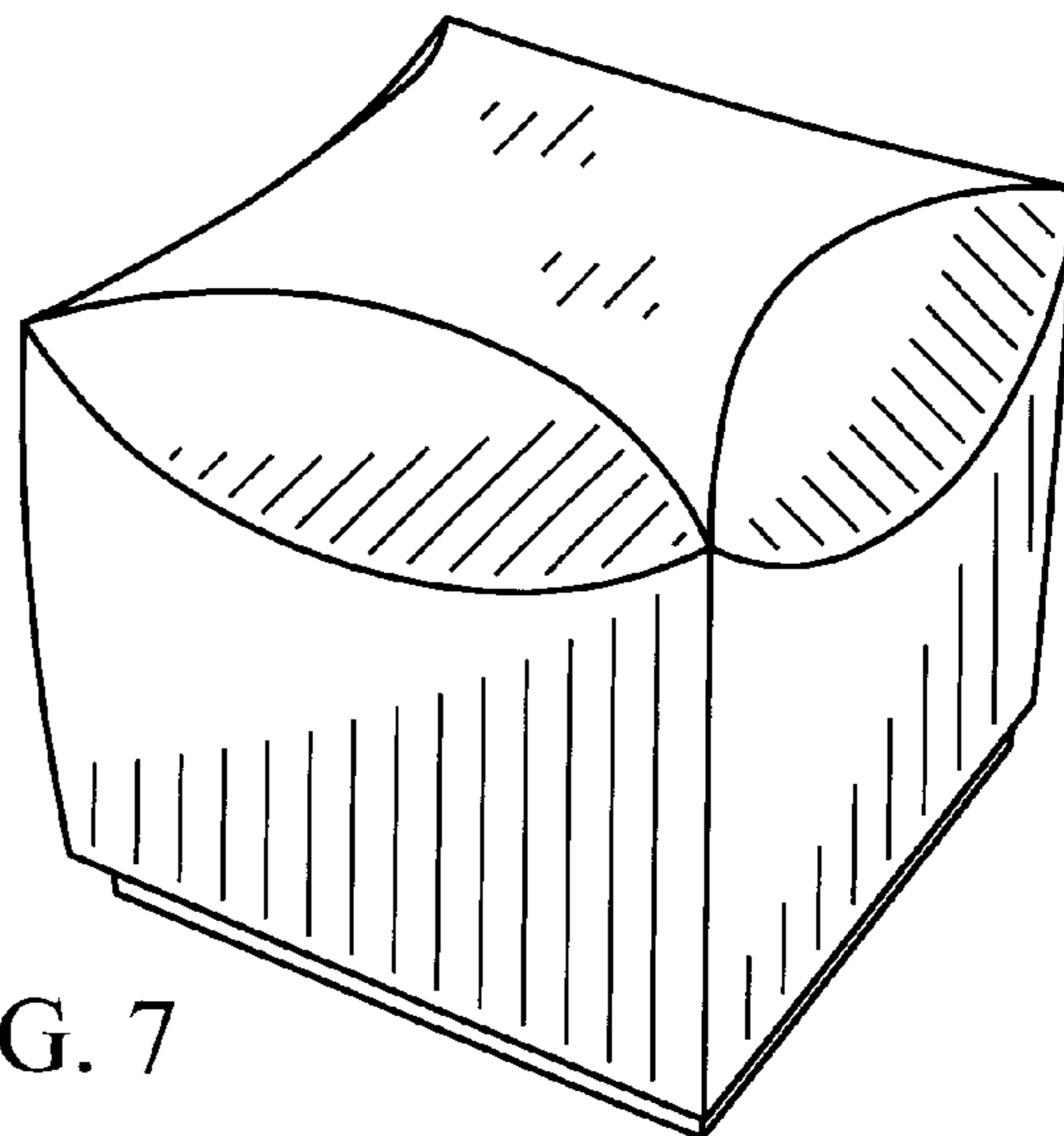

FIG. 7