



US00D534069S

(12) **United States Design Patent** (10) **Patent No.:** **US D534,069 S**
Ohno et al. (45) **Date of Patent:** **** Dec. 26, 2006**

(54) **PACKAGING CONTAINER**

(75) Inventors: **Masahiro Ohno**, Saitama (JP); **Hiroshi Kitsutaka**, Chiba (JP); **Kenichi Noguchi**, Tokyo-to (JP)

(73) Assignee: **Otsuka Pharmaceutical Co. Ltd.**, Tokyo (JP)

(**) Term: **14 Years**

(21) Appl. No.: **29/226,848**

(22) Filed: **Apr. 4, 2005**

(30) **Foreign Application Priority Data**

Oct. 4, 2004 (JP) 2004-030030

(51) **LOC (8) Cl.** **09-03**

(52) **U.S. Cl.** **D9/425; D9/424**

(58) **Field of Classification Search** D9/414,
D9/423, 424, 426, 432; D3/201, 203.2; 206/530,
206/538, 539, 815

See application file for complete search history.

(56) **References Cited**

U.S. PATENT DOCUMENTS

- 2,295,747 A * 9/1942 Mills 220/351
- 3,833,143 A * 9/1974 Starkermann et al. 220/351
- D432,911 S * 10/2000 Clarke et al. D9/415
- D446,718 S * 8/2001 Anderson D9/422
- 6,341,710 B1 * 1/2002 Danielson et al. 220/281
- D465,729 S * 11/2002 Nishimura D9/422
- D479,462 S * 9/2003 Chan D9/422
- 2001/0001674 A1 * 5/2001 Simpson et al. 426/107

FOREIGN PATENT DOCUMENTS

JP 2527511 3/1997

* cited by examiner

Primary Examiner—Stella Reid
Assistant Examiner—Derrick Holland
(74) *Attorney, Agent, or Firm*—Finnegan, Henderson, Farabow, Garrett & Dunner, L.L.P.

(57) **CLAIM**

The ornamental design for a packaging container, as shown and described.

DESCRIPTION

FIG. 1 is a perspective view of a packaging container showing our new design which consists of a lid member and a body member;

FIG. 2 is a front elevational view thereof;

FIG. 3 is a rear elevational view thereof;

FIG. 4 is a top plan view thereof;

FIG. 5 is a bottom plan view thereof;

FIG. 6 is a right side elevational view thereof;

FIG. 7 is a left side elevational view thereof;

FIG. 8 is a front elevational view of the lid member of the packaging container of FIG. 1;

FIG. 9 is a rear elevational view of FIG. 8;

FIG. 10 is a top plan view of FIG. 8;

FIG. 11 is a bottom plan view of FIG. 8;

FIG. 12 is a right side elevated view of FIG. 8;

FIG. 13 is a left side elevational view of FIG. 8;

FIG. 14 is a front elevational view of the body member of the packaging container of FIG. 1;

FIG. 15 is a rear elevational view of FIG. 14;

FIG. 16 is a top plan view of FIG. 14;

FIG. 17 is a bottom plan view of FIG. 14;

FIG. 18 is a right side elevational view of FIG. 14;

FIG. 19 is a left side elevational view of FIG. 14; and,

FIG. 20 is a sectional view taken along the line 20—20 of FIG. 4 with the lid member in a closed position.

The broken lines showing a plate spring in FIGS. 16 and 20 are for illustrative purposes only and form no part of the claimed design.

1 Claim, 6 Drawing Sheets

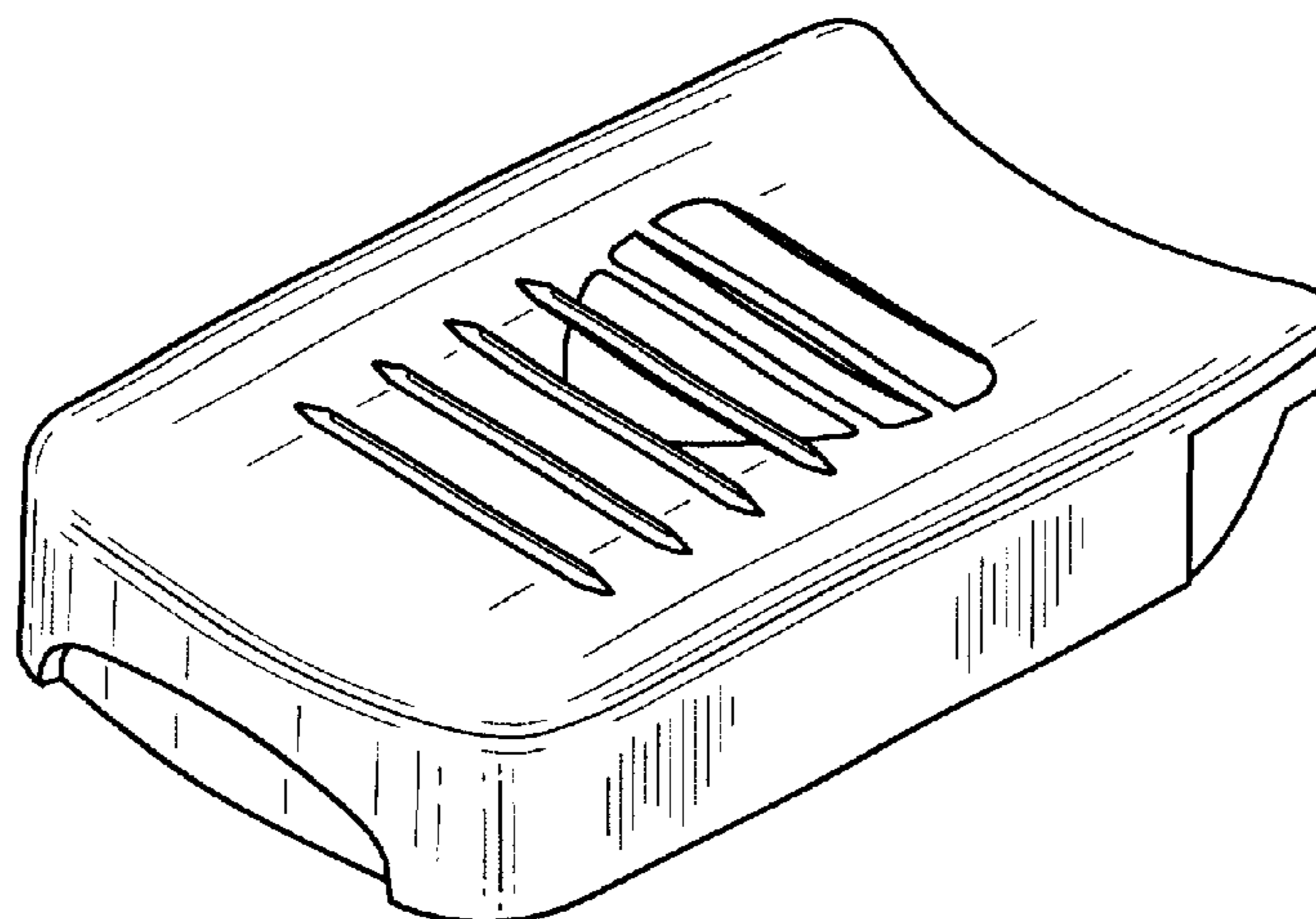

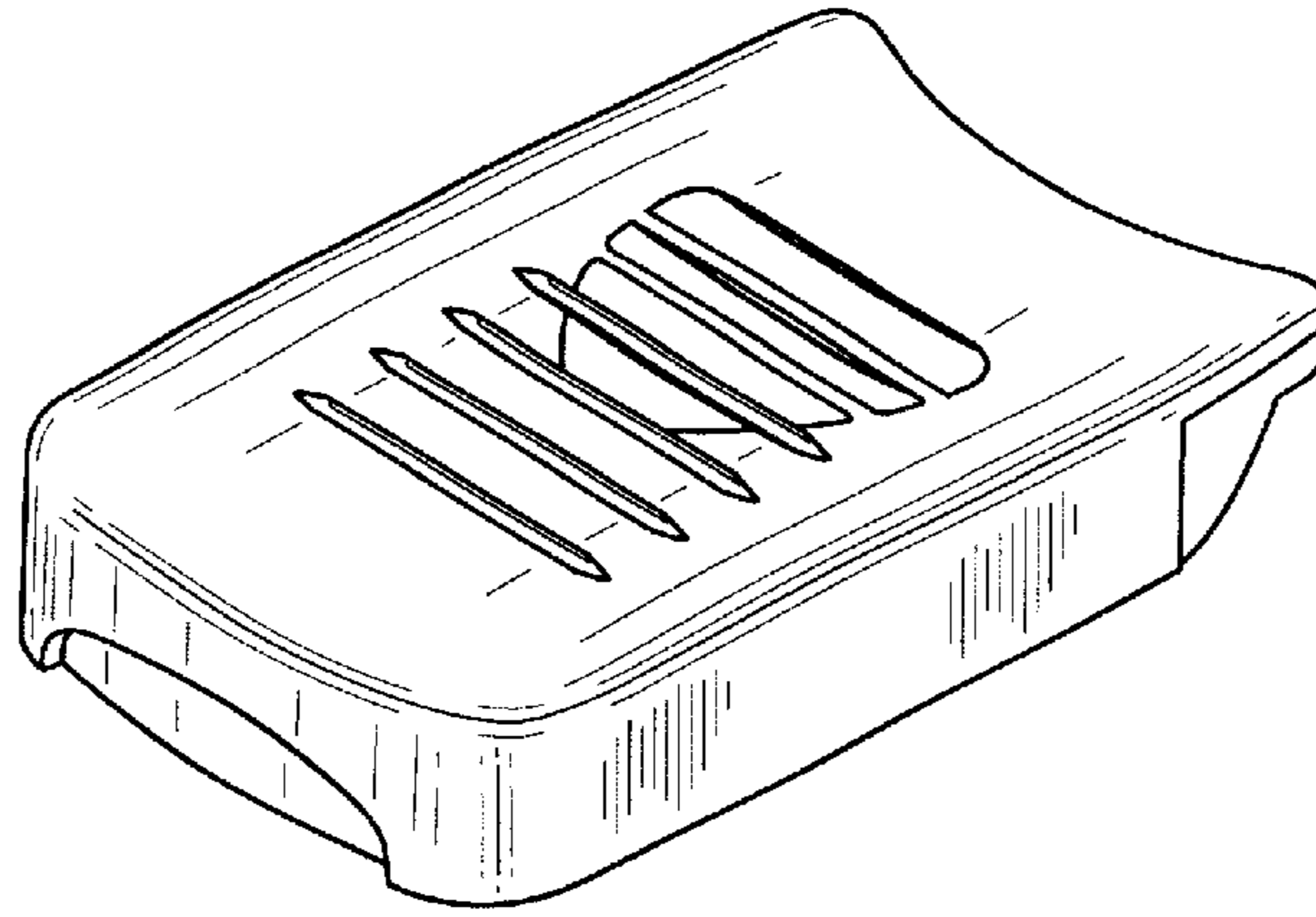

FIG. 1

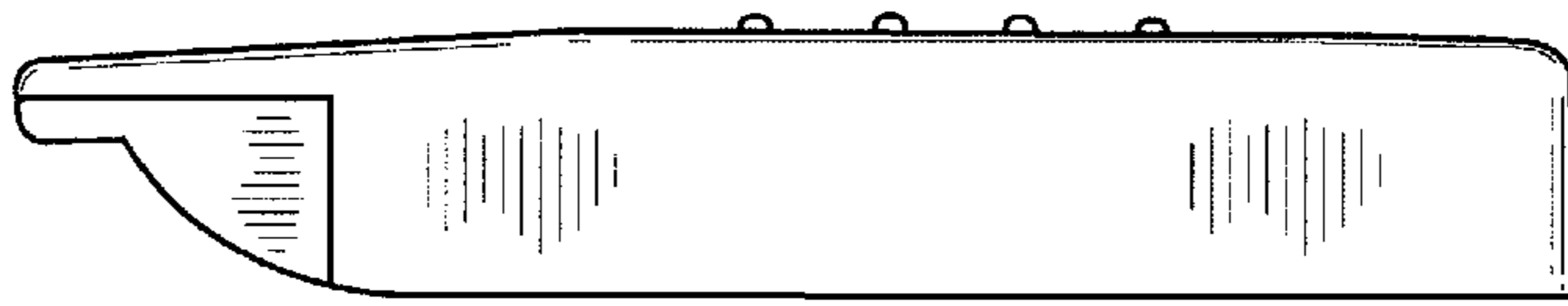

FIG. 2

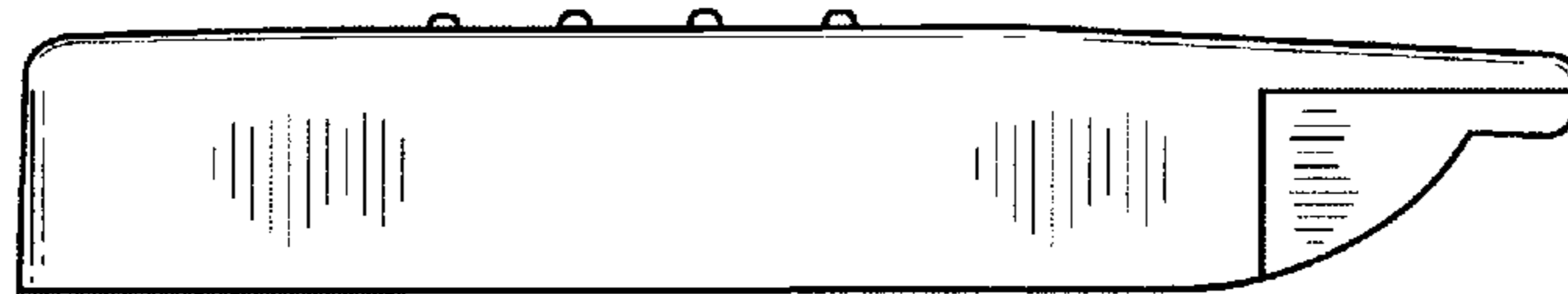

FIG. 3

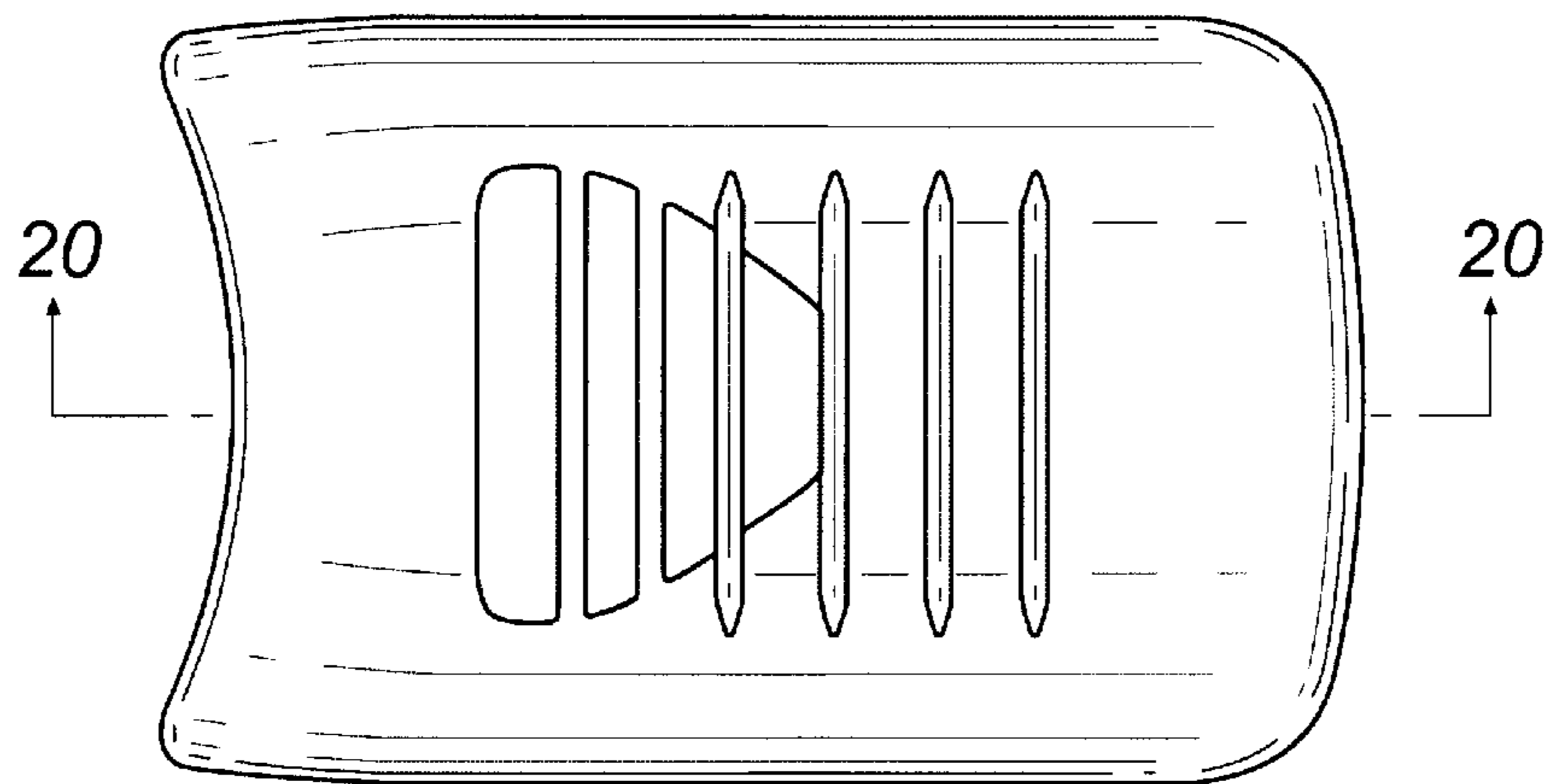

FIG. 4

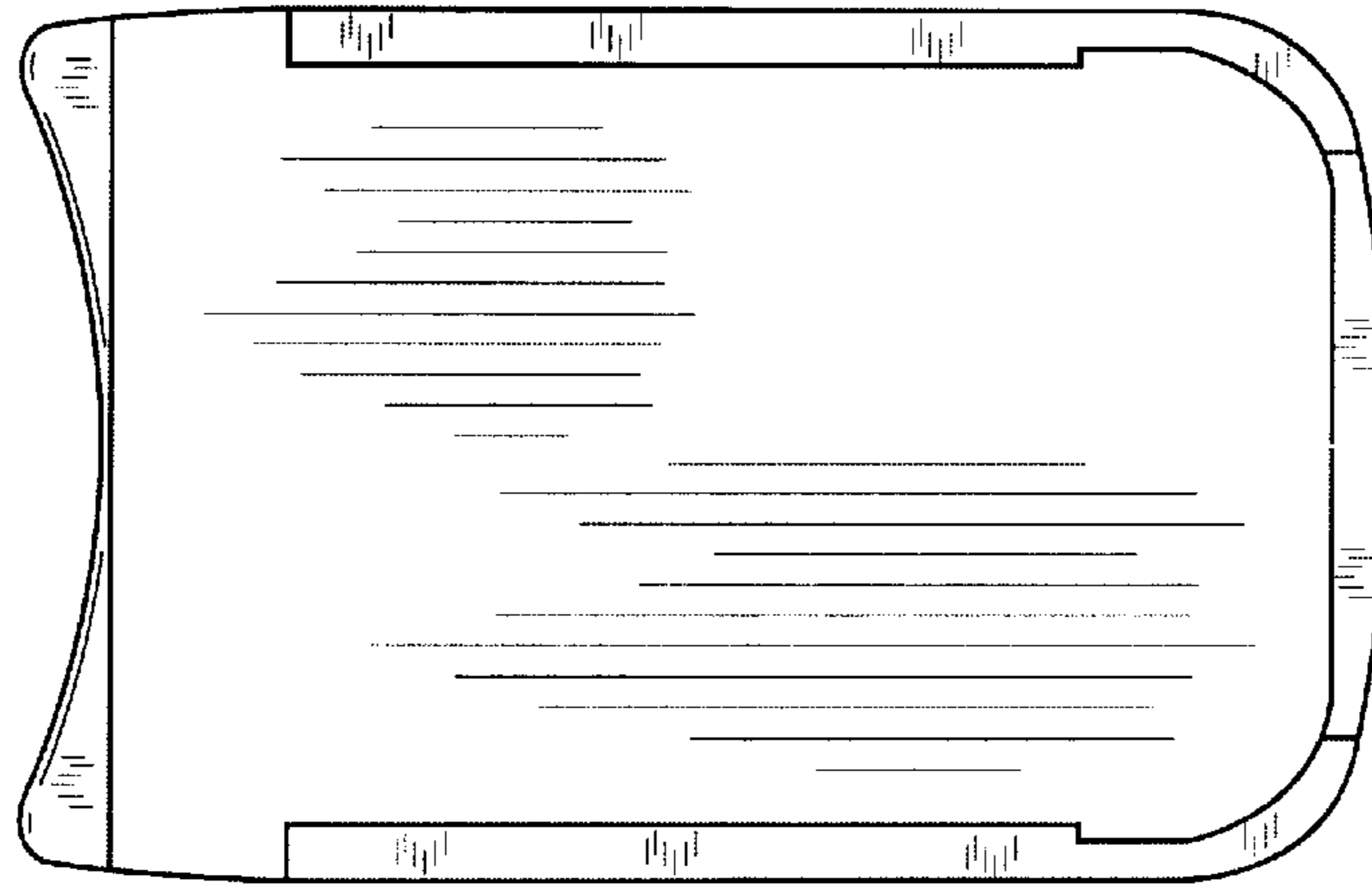

FIG. 5

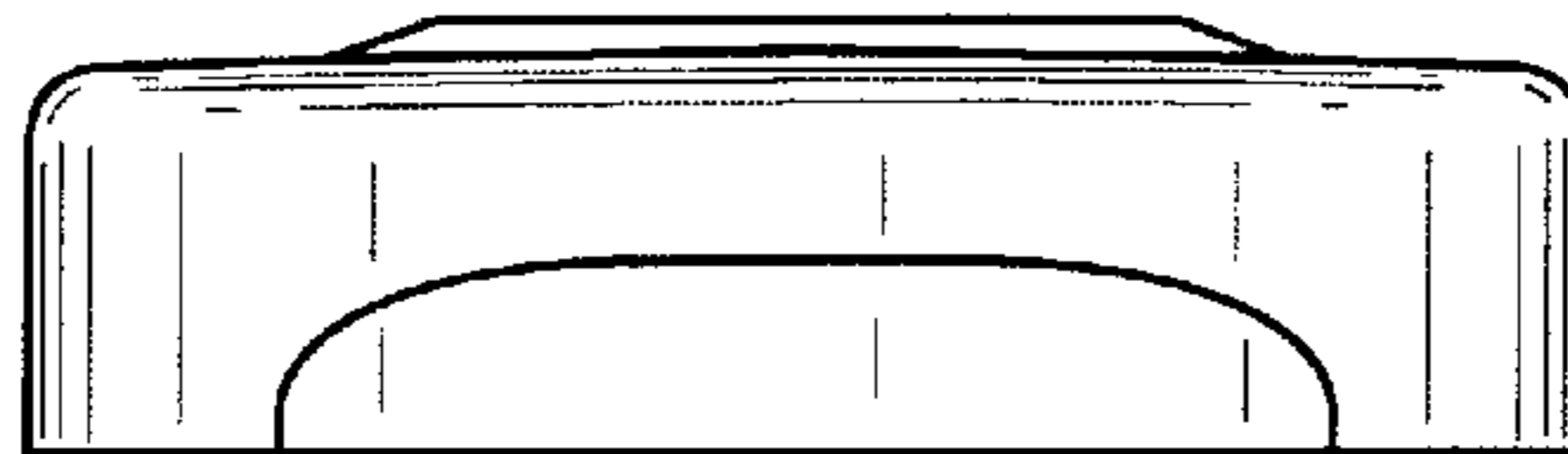

FIG. 6

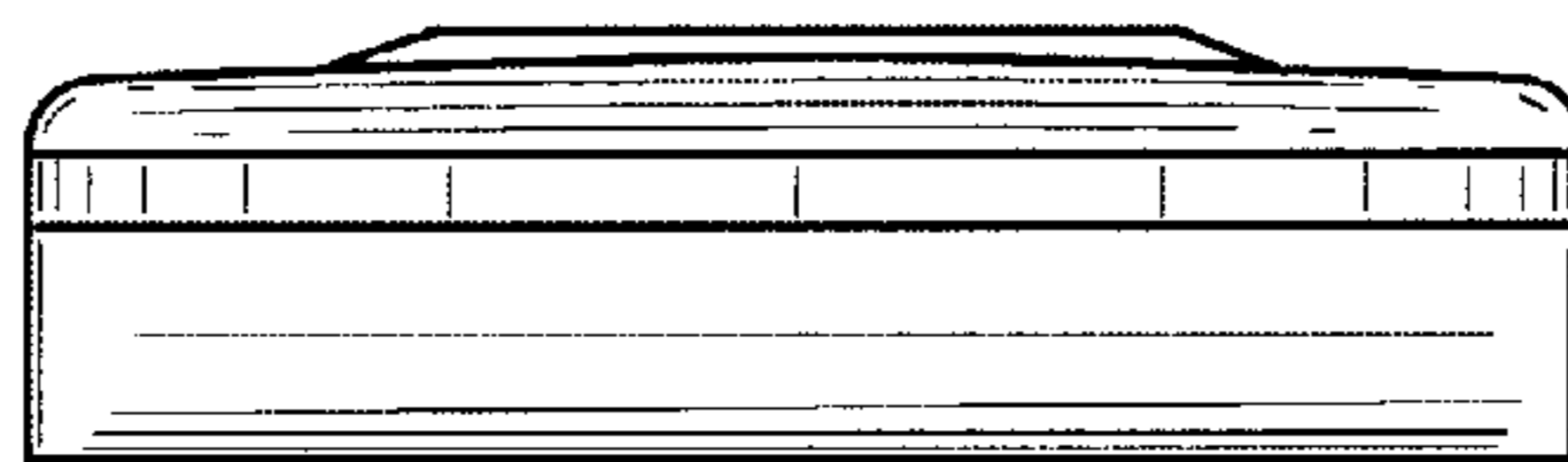

FIG. 7

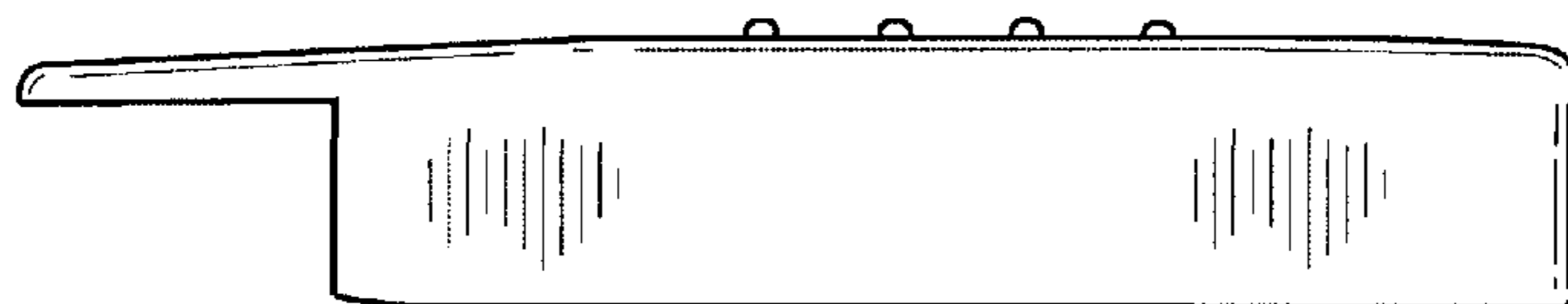

FIG. 8

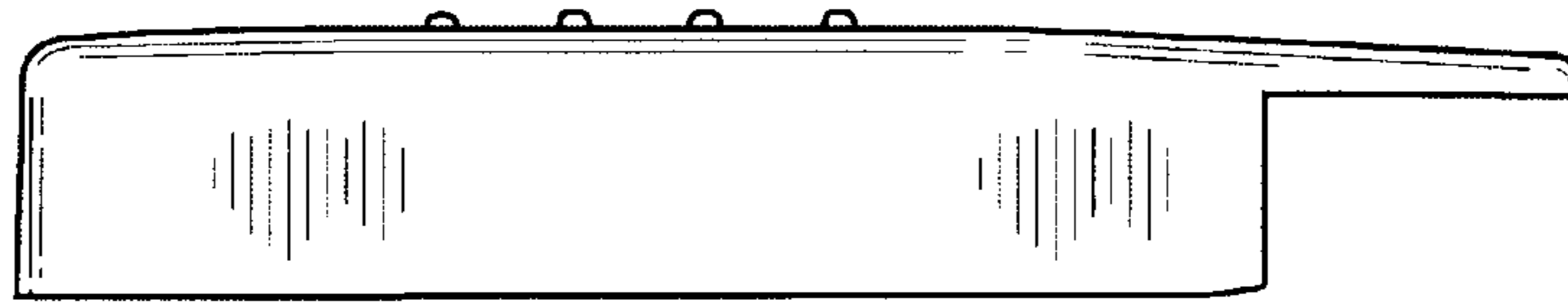

FIG. 9

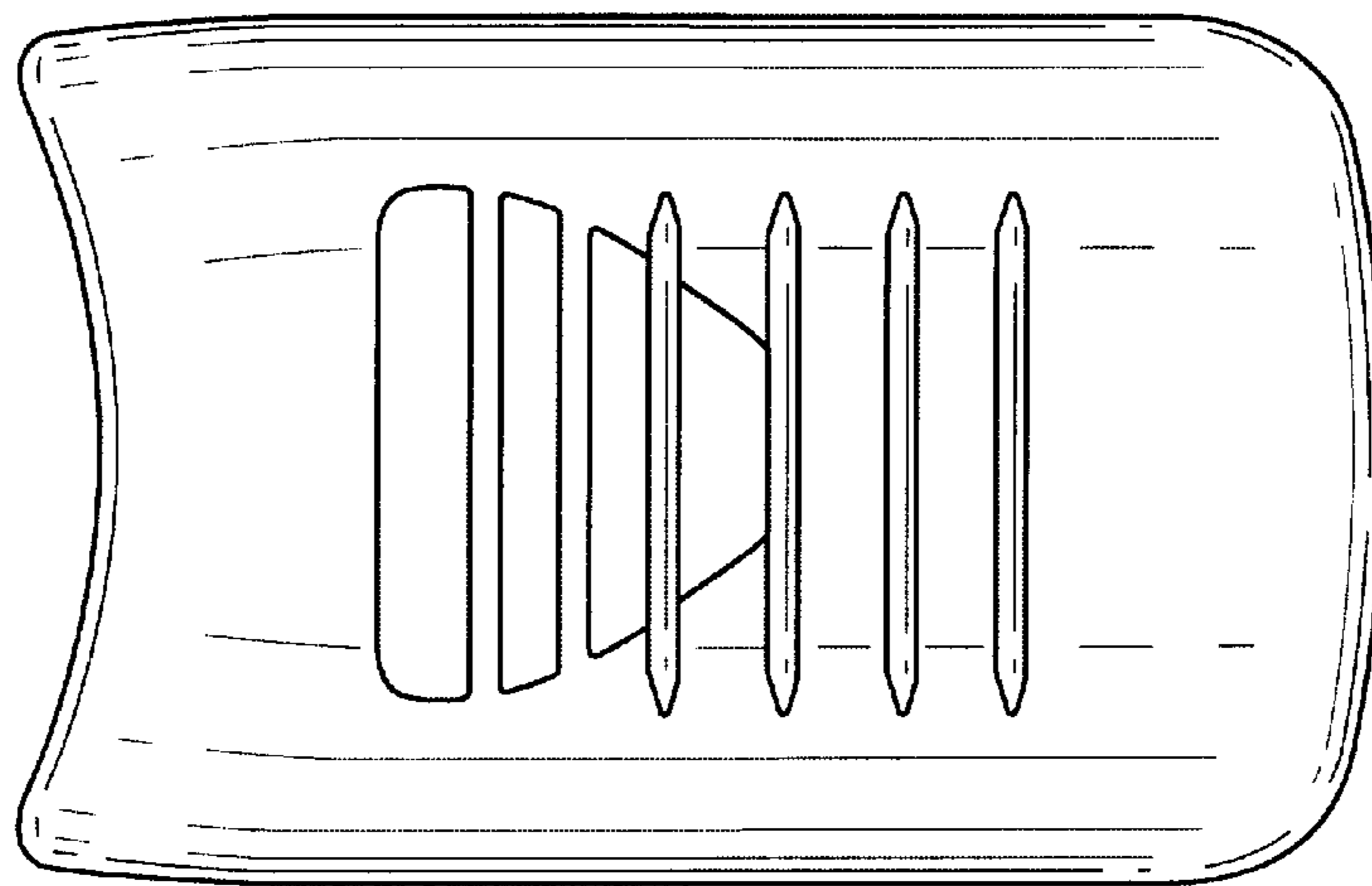

FIG. 10

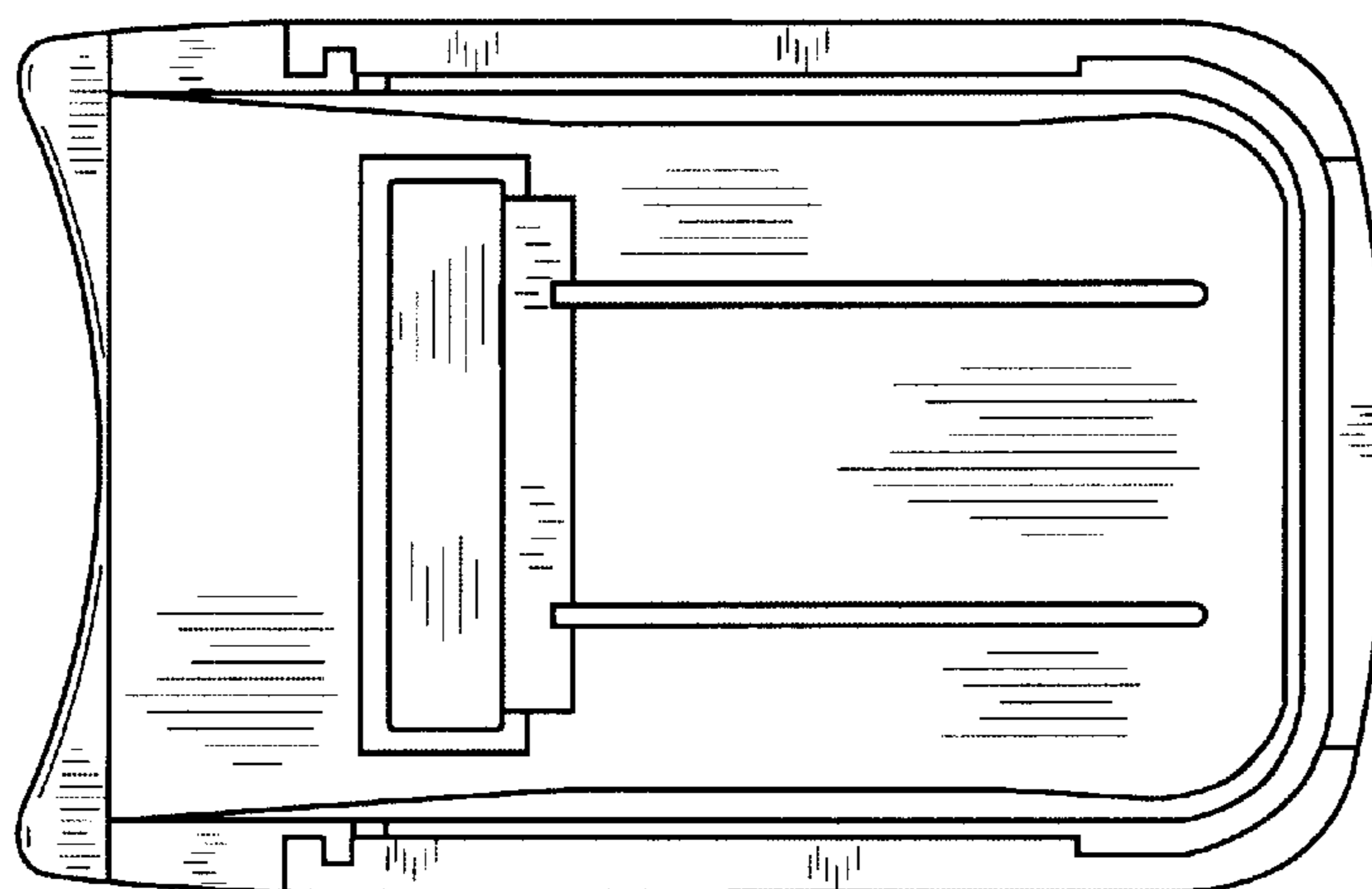

FIG. 11

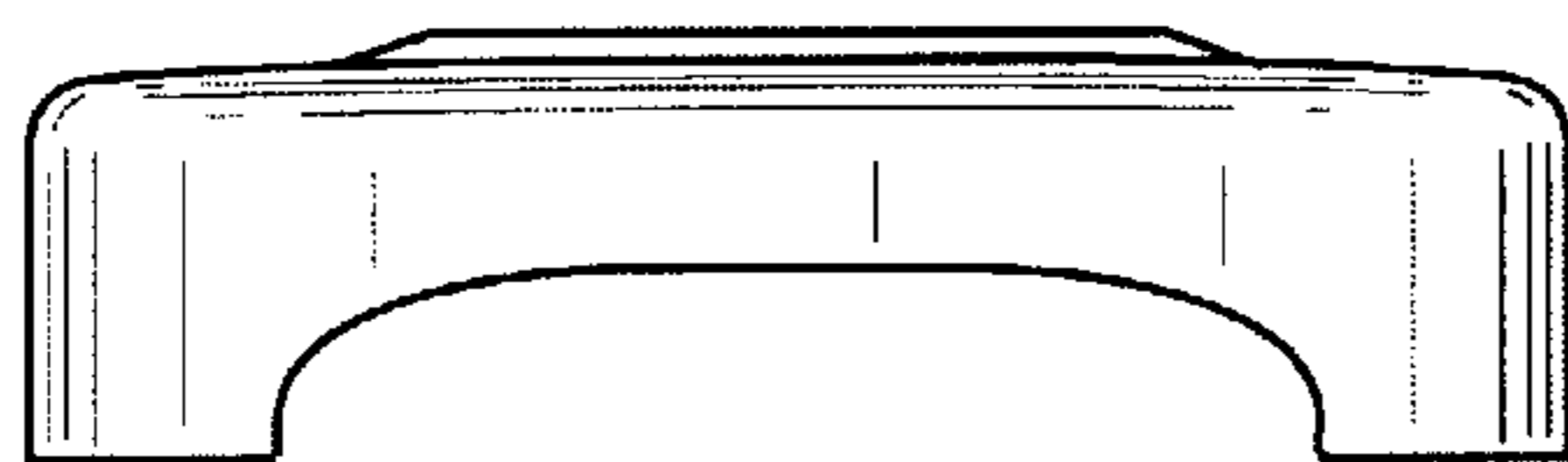

FIG. 12

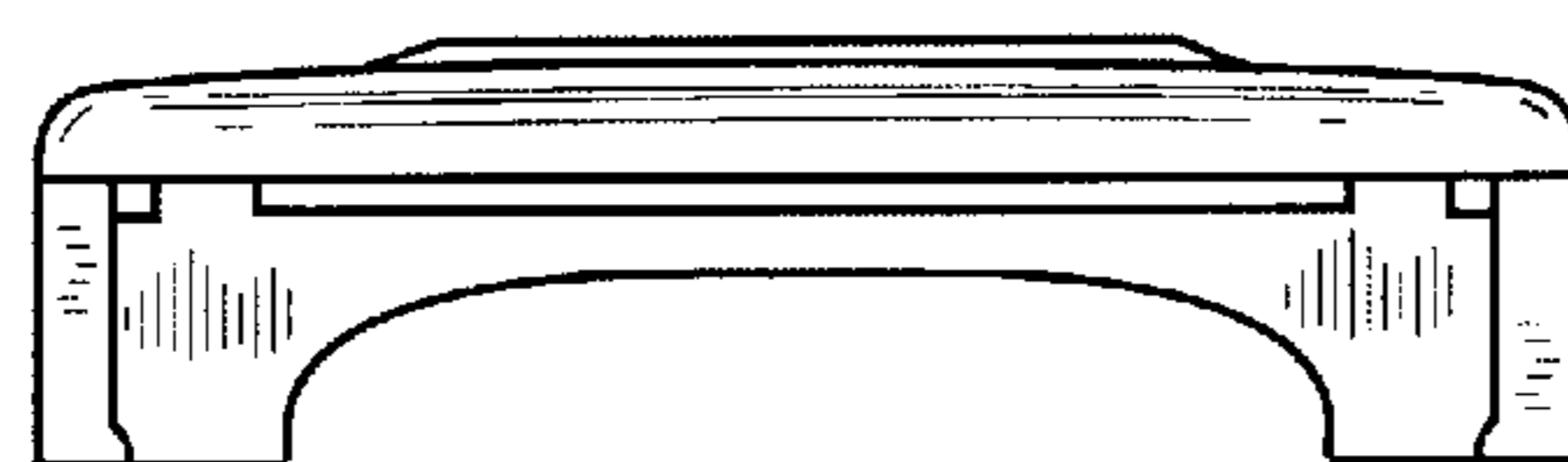

FIG. 13

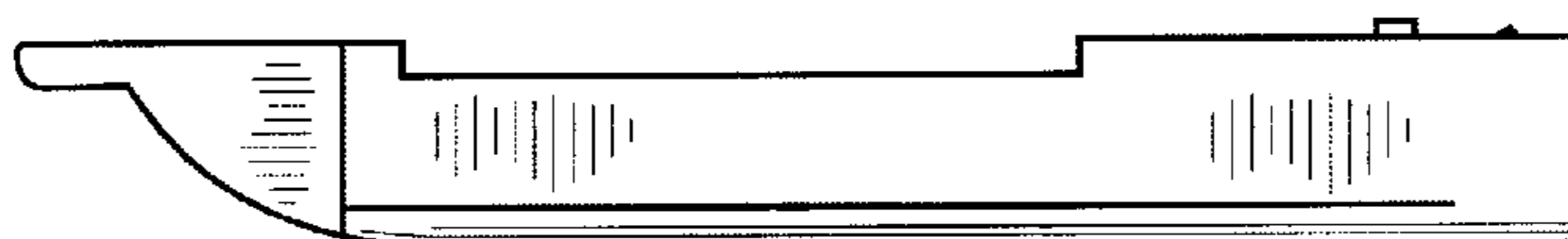

FIG. 14

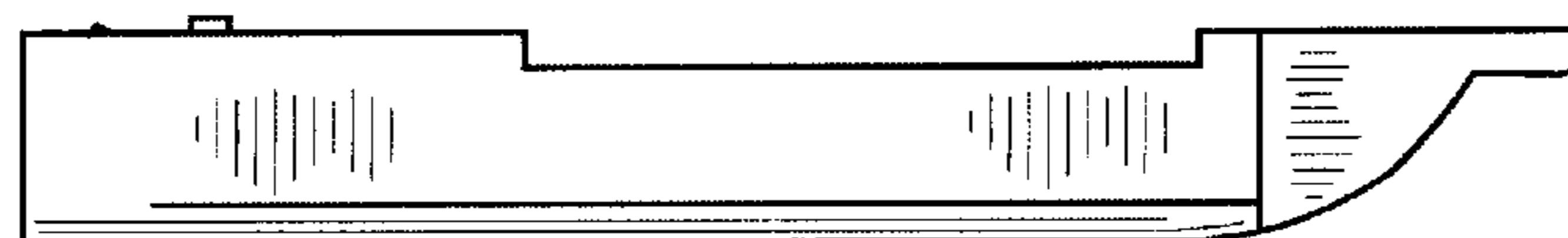

FIG. 15

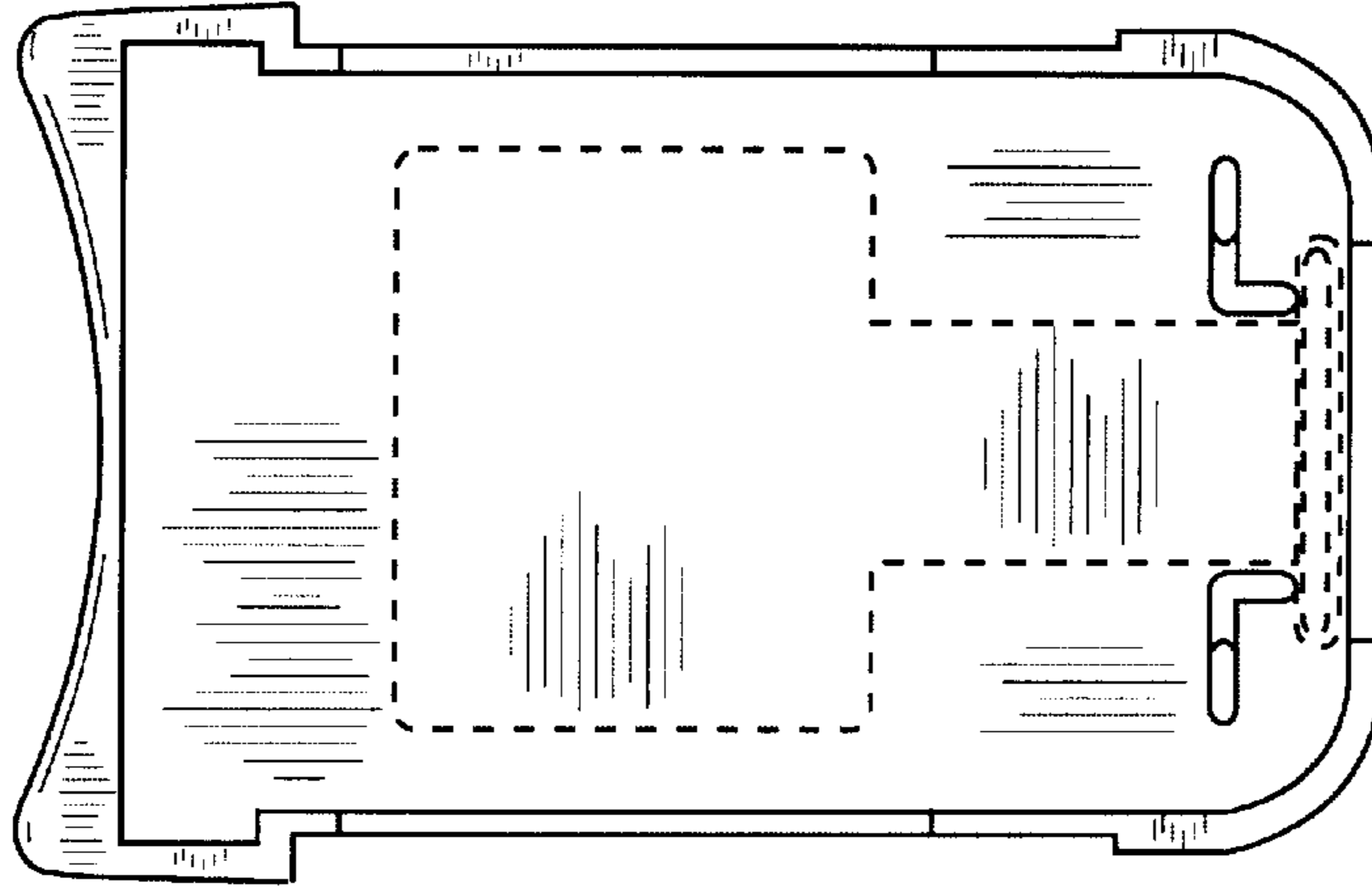

FIG. 16

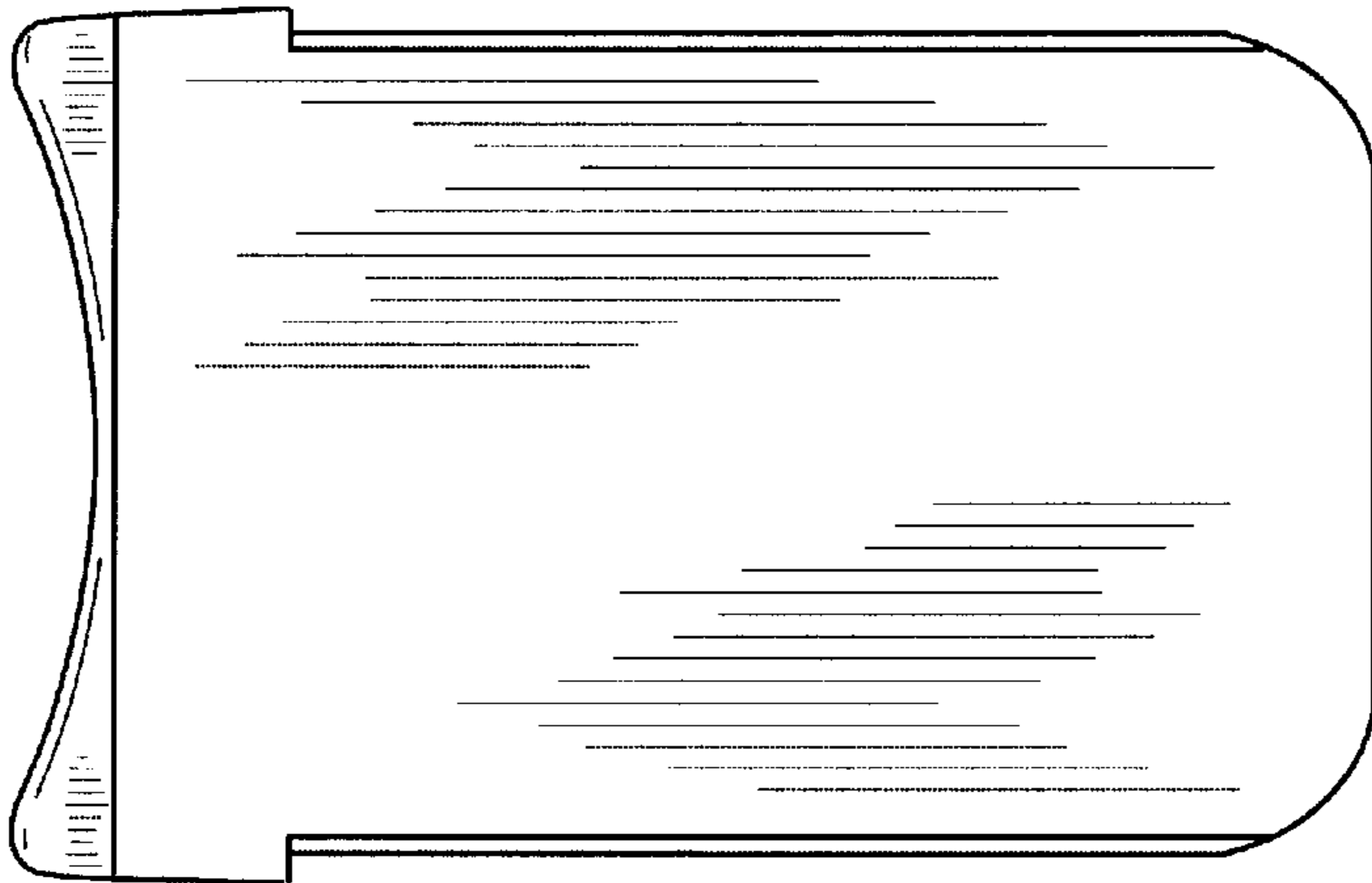

FIG. 17

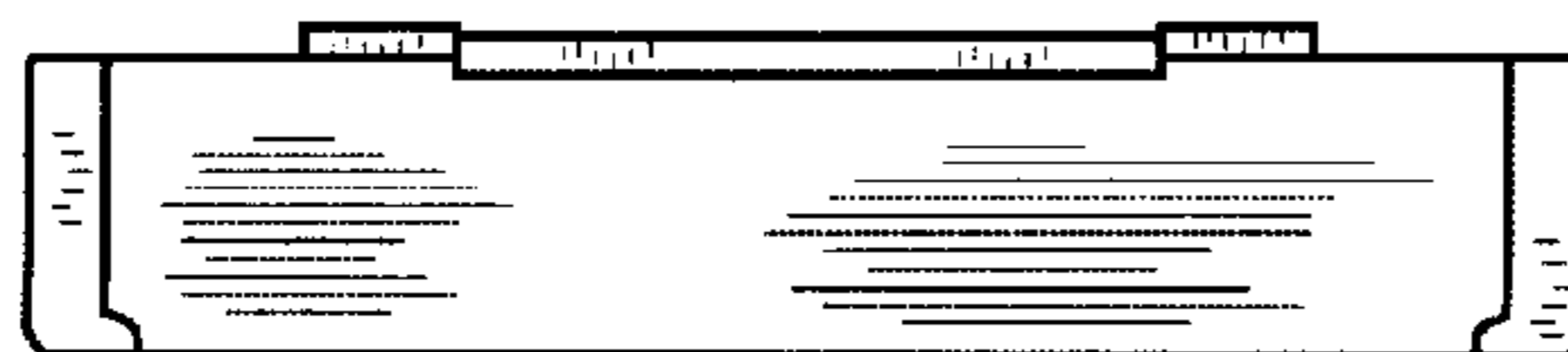

FIG. 18

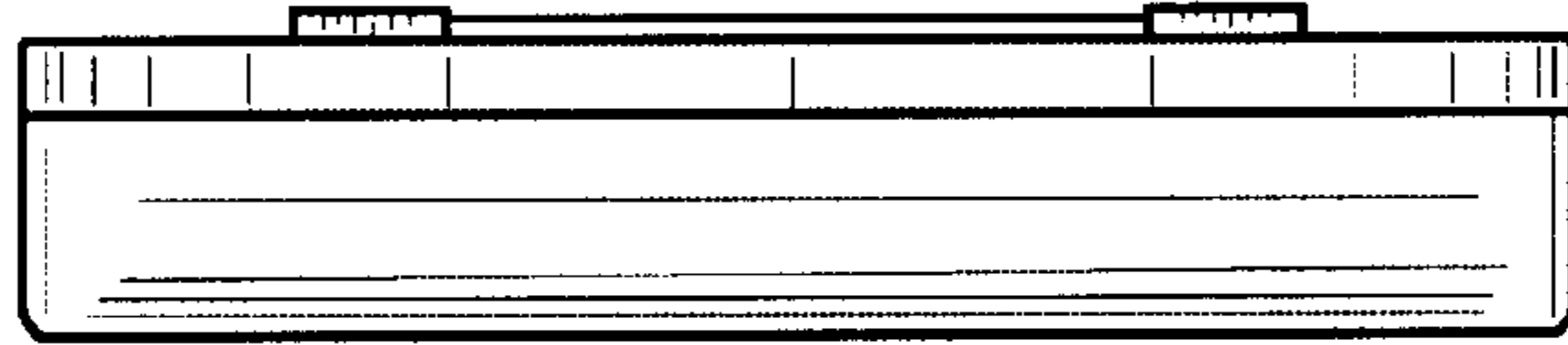

FIG. 19

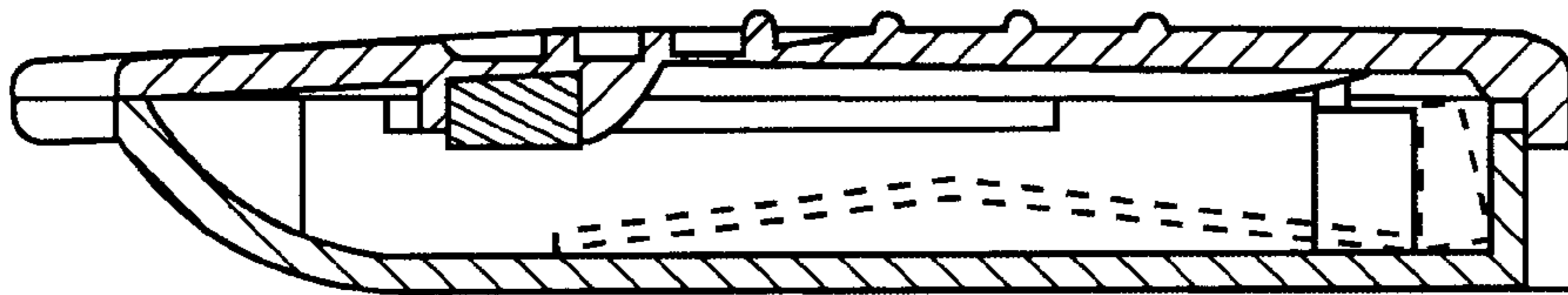

FIG. 20