

US00D534043S

(12) **United States Design Patent**
Plunkett

(10) **Patent No.:** **US D534,043 S**

(45) **Date of Patent:** **** Dec. 26, 2006**

(54) **PASTRY BLENDER/VEGETABLE MASHER**

(76) **Inventor:** **Michael Patrick Plunkett**, 350
Shoreacres Road, Burlington, Ontario
(CA), L7L 2H5

(**) **Term:** **14 Years**

(21) **Appl. No.:** **29/229,587**

(22) **Filed:** **May 10, 2005**

(51) **LOC (8) Cl.** **07-04**

(52) **U.S. Cl.** **D7/682**

(58) **Field of Classification Search** D7/681-696,
D7/393, 395; D8/107; 16/110.1, 430, 431;
30/322-324, 346; 241/168, 169.2; 366/129
See application file for complete search history.

(56) **References Cited**

U.S. PATENT DOCUMENTS

D109,993 S * 6/1938 Wamer D7/682
2,559,186 A * 7/1951 Caylor 241/169.2
2,726,696 A * 12/1955 Filthuth 241/169.2

3,865,317 A * 2/1975 Brehm 241/169.2
D255,636 S * 7/1980 Kelly D7/682
D291,761 S * 9/1987 Hoehne D7/682
D447,392 S * 9/2001 Johansson et al. D7/682

* cited by examiner

Primary Examiner—Terry A. Wallace

(74) *Attorney, Agent, or Firm*—Robert F. Delbridge

(57) **CLAIM**

The ornamental design of a pastry blender/vegetable masher,
as shown and described.

DESCRIPTION

FIG. 1 is a perspective view from above of a pastry
blender/vegetable masher showing my new design;
FIG. 2 is a perspective view from below thereof;
FIG. 3 is a front view thereof;
FIG. 4 is a side view thereof;
FIG. 5 is a top view thereof; and,
FIG. 6 is a bottom view thereof.

1 Claim, 3 Drawing Sheets

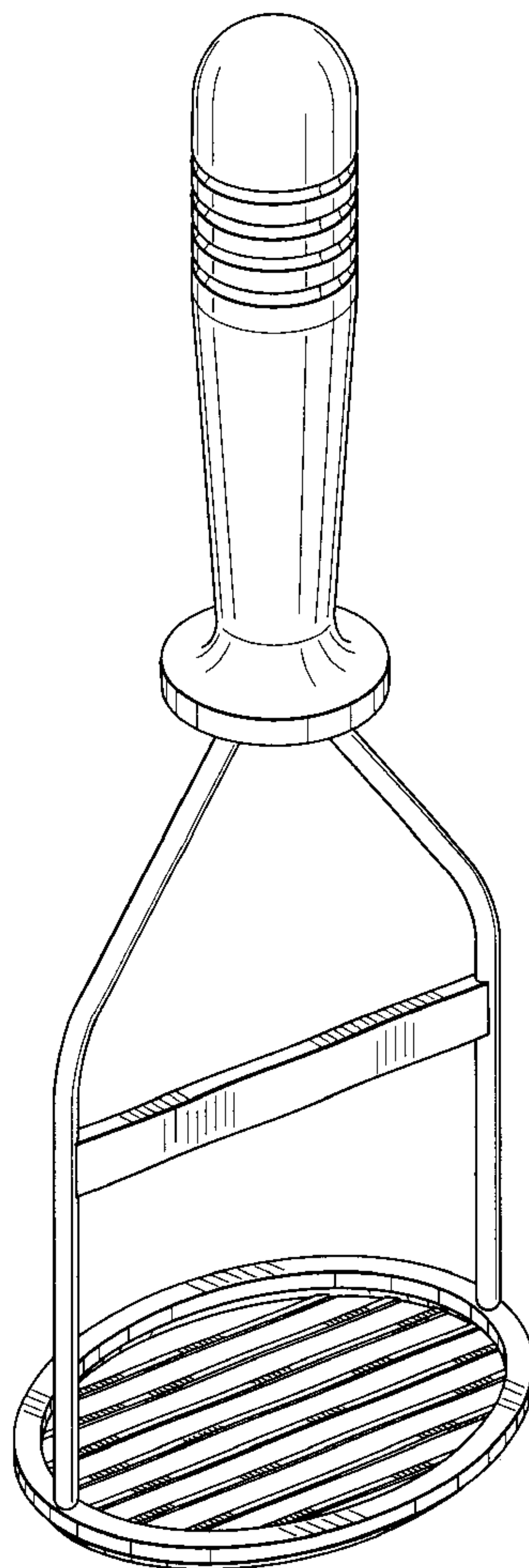

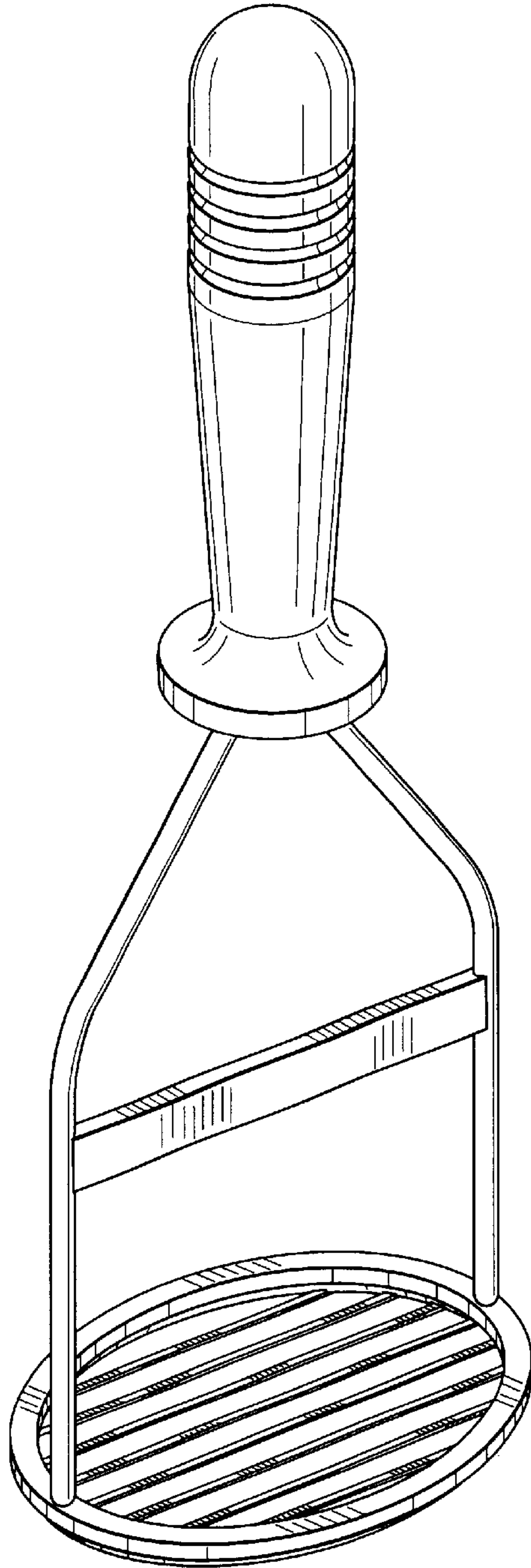

FIG. 1

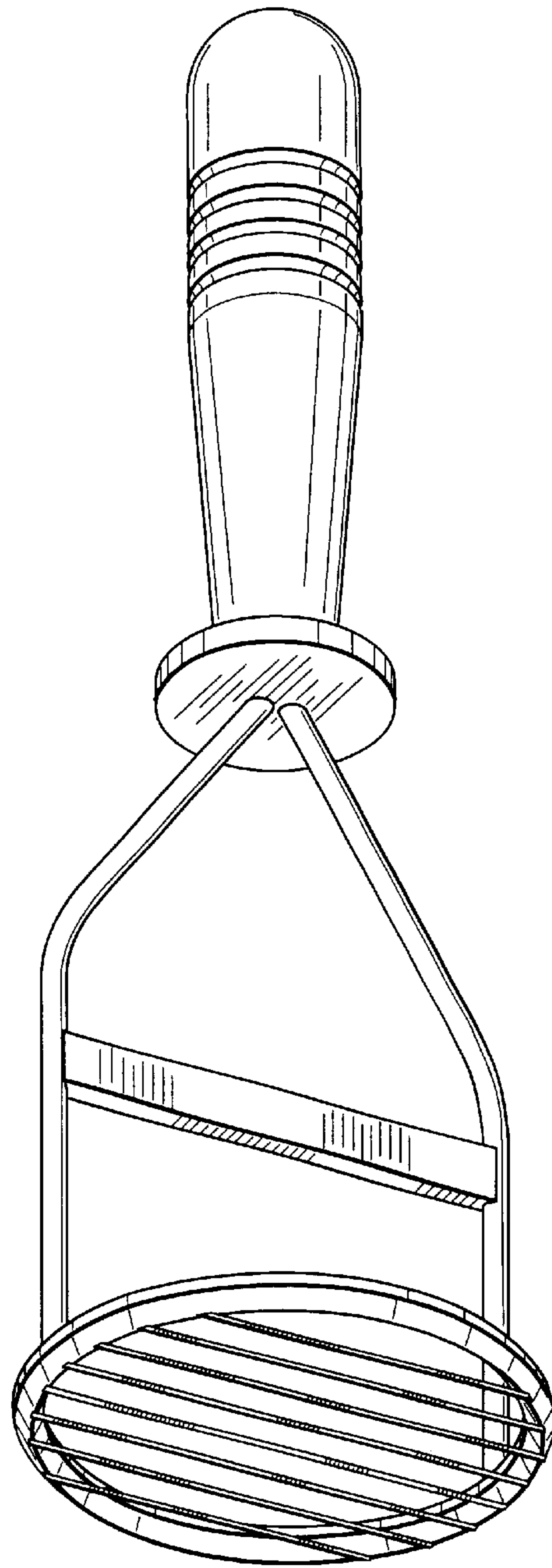

FIG. 2

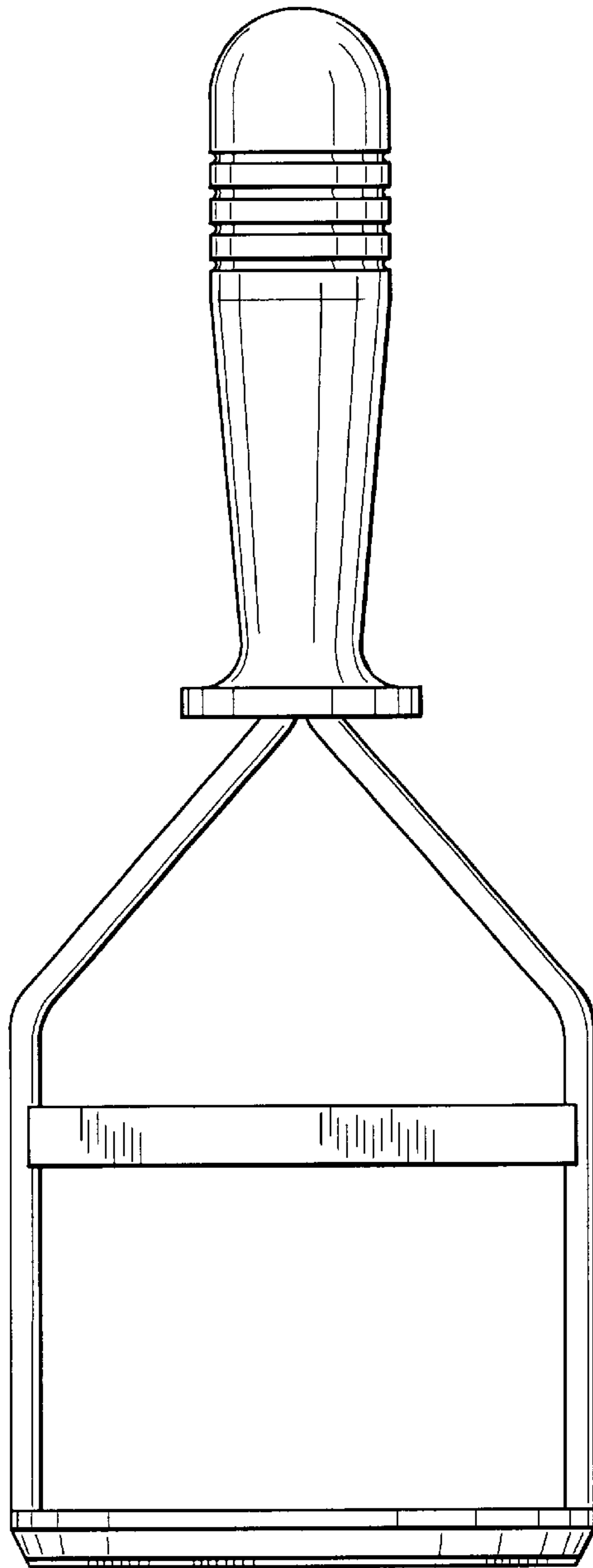

FIG. 3

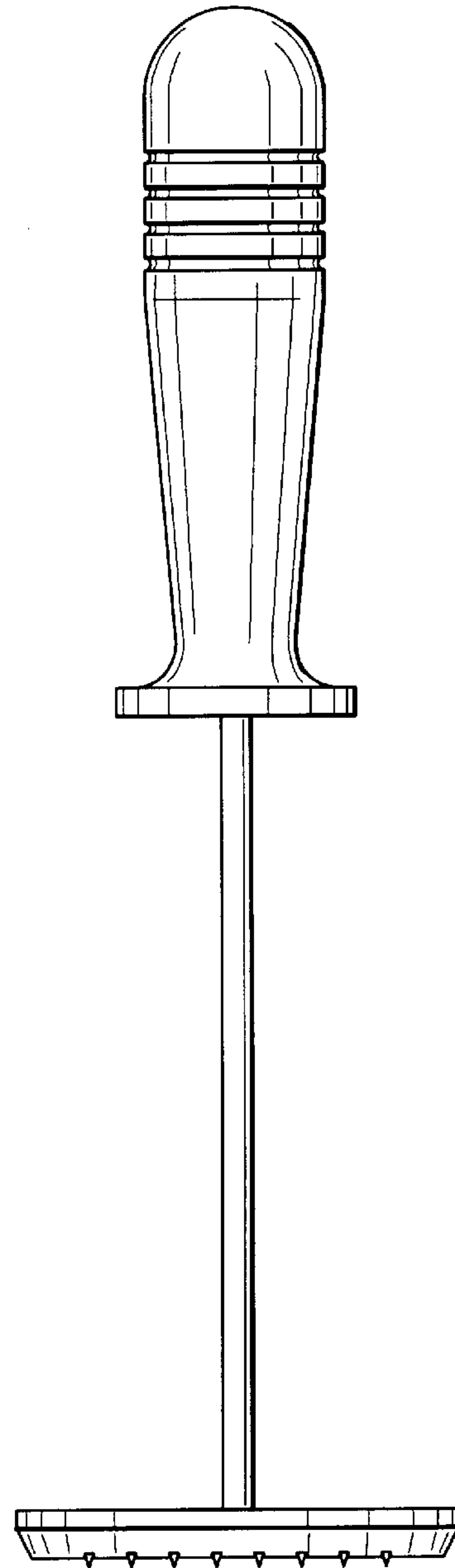

FIG. 4

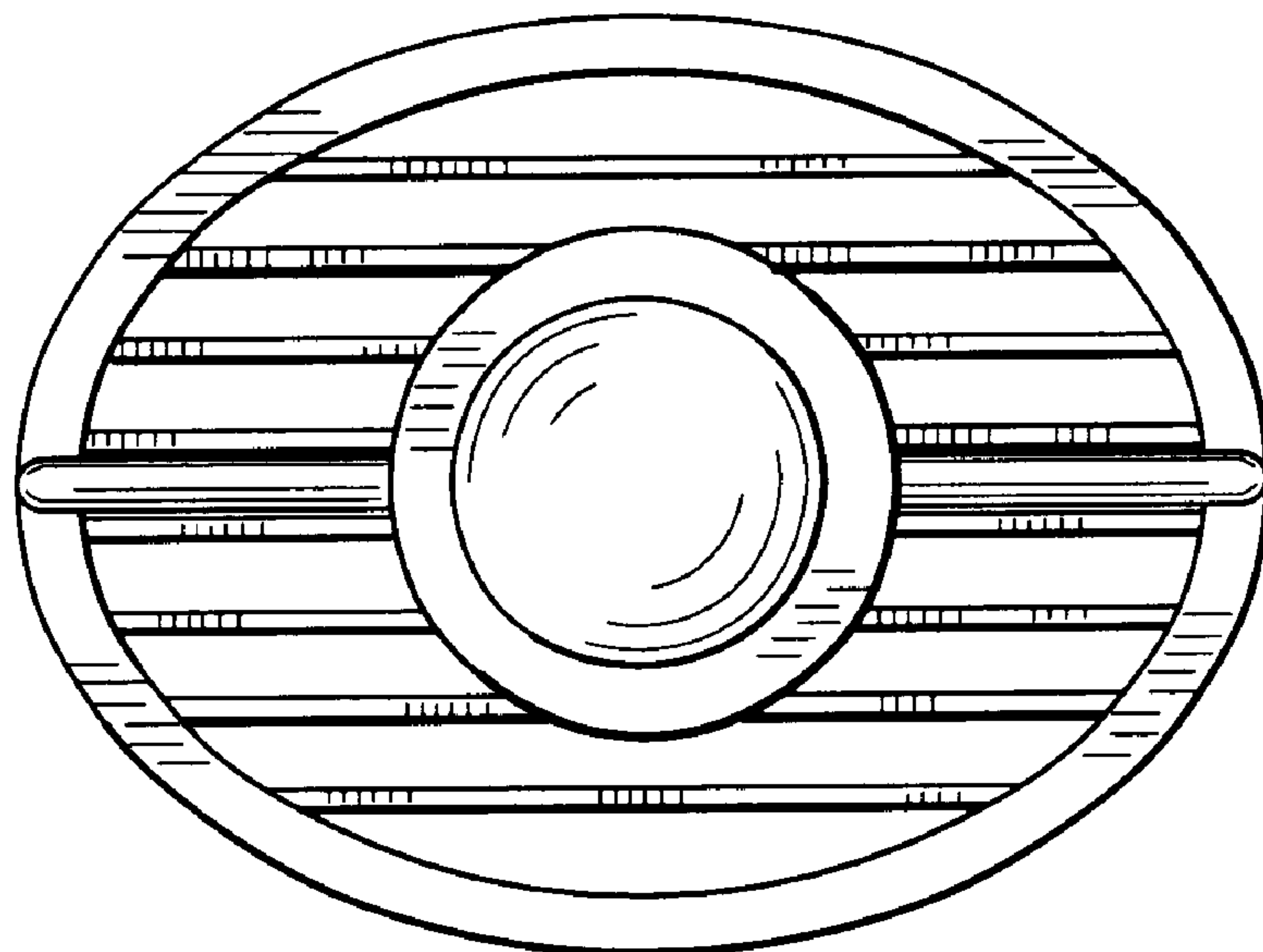

FIG. 5

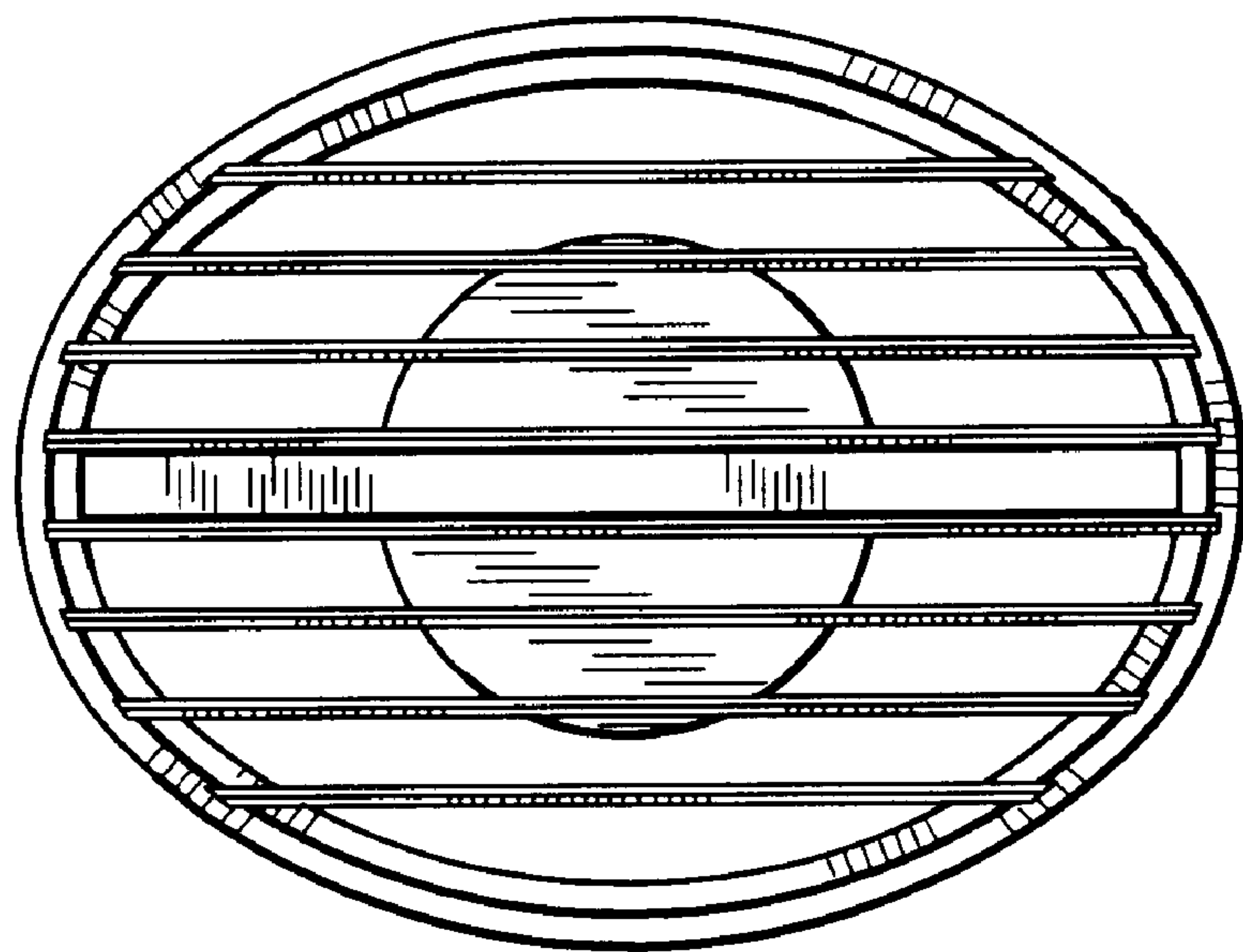

FIG. 6