



US00D533902S

(12) **United States Design Patent**
Tak

(10) **Patent No.:** **US D533,902 S**

(45) **Date of Patent:** **** Dec. 19, 2006**

(54) **DRY ERASE AND CHALKBOARD DESK WITH CONNECTOR**

(75) Inventor: **Yeung Kai Tak**, Hong Kong (HK)

(73) Assignee: **First Learning Company Limited**,
Kowloon (HK)

(**) Term: **14 Years**

(21) Appl. No.: **29/242,490**

(22) Filed: **Nov. 12, 2005**

(51) **LOC (8) Cl.** **19-06**

(52) **U.S. Cl.** **D19/52; D6/310; D6/420**

(58) **Field of Classification Search** D6/300,
D6/310, 311, 312, 397, 420, 429, 430, 509;
D19/36, 37, 52, 88, 91; D20/10; 40/1, 606.1,
40/611.2, 700; 248/441.1, 451, 460; 312/230,
312/231; 428/81; 434/408-424

See application file for complete search history.

(56) **References Cited**

U.S. PATENT DOCUMENTS

1,588	A	*	5/1840	Davison	434/425
1,989,216	A	*	1/1935	Shaw et al.	434/408
D142,850	S	*	11/1945	Geffner	D6/397
2,397,405	A	*	3/1946	Burkeman	434/417
2,485,517	A	*	10/1949	Vaule et al.	248/464
2,700,587	A	*	1/1955	Godfrey	312/231
2,808,308	A	*	10/1957	Papelian et al.	312/231
2,961,786	A	*	11/1960	Lowmaster	40/606.14
2,981,030	A	*	4/1961	Knop	211/74
3,467,259	A	*	9/1969	Silver	211/74
3,599,925	A	*	8/1971	Dubler	248/352
4,098,008	A	*	7/1978	Schuette et al.	34/191

D273,828	S	*	5/1984	Oshry	D6/397
4,824,064	A	*	4/1989	Oncale	248/441.1
4,971,284	A	*	11/1990	Curry	248/460
D385,126	S	*	10/1997	Howland et al.	D6/406.6
D431,910	S	*	10/2000	Glass	D6/310
6,837,385	B1	*	1/2005	Bennett et al.	211/118
D503,296	S	*	3/2005	Mason	D6/397
D505,803	S	*	6/2005	Mason	D6/406.6

* cited by examiner

Primary Examiner—Elizabeth A. Albert

(74) *Attorney, Agent, or Firm*—Jennifer Meredith;
Meredith & Keyhani, PLLC

(57) **CLAIM**

The ornamental design for the dry erase and chalkboard desk with connector, as shown and described.

DESCRIPTION

FIG. 1 is a front view of the dry erase and chalkboard desk with connector showing my new design;
 FIG. 2 is a side view thereof;
 FIG. 3 is a top view thereof;
 FIG. 4 is a bottom view thereof;
 FIG. 5 is a back view thereof, with the legs folded under it;
 FIG. 6 is a side view thereof;
 FIG. 7 is a bottom view thereof;
 FIG. 8 is a top detail view of the connector shown attached to a fragment of FIG. 1;
 FIG. 9 is another top detail view of FIG. 8 shown by itself for convenience; and,
 FIG. 10 is an exploded view of the two boards of FIG. 1 with connectors in flat condition, shown without the lower portion of FIG. 1 for convenience.

1 Claim, 5 Drawing Sheets

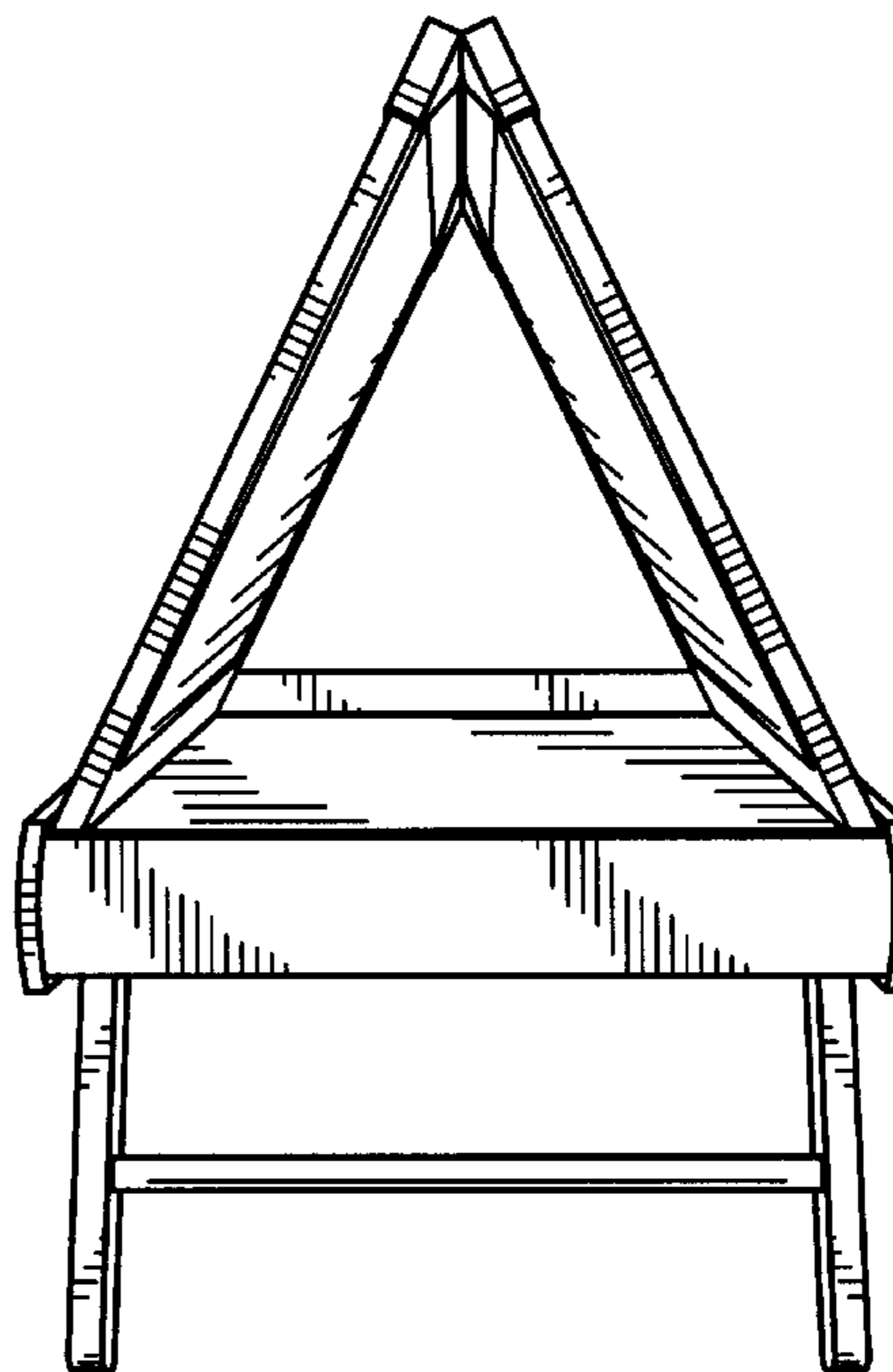
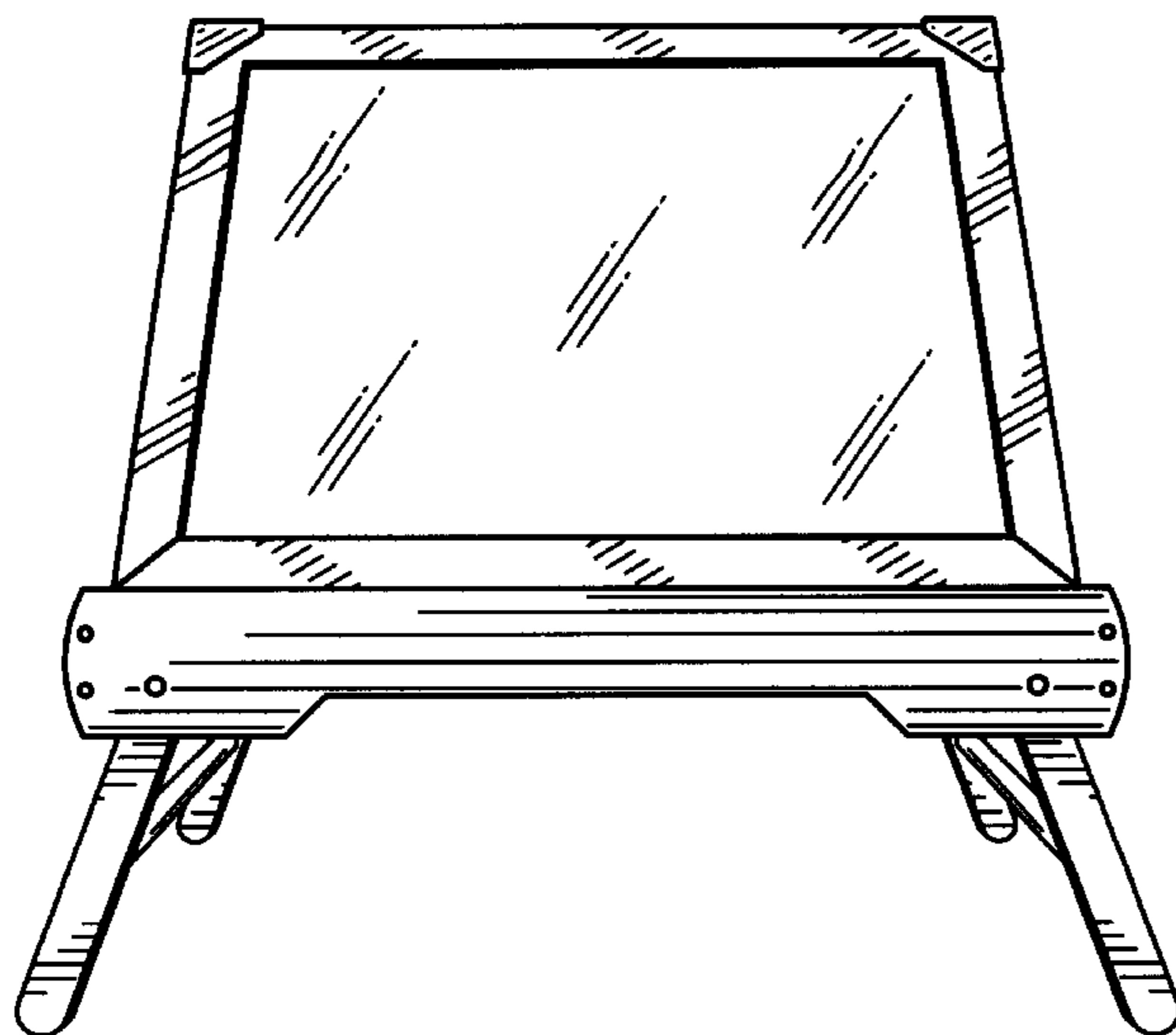

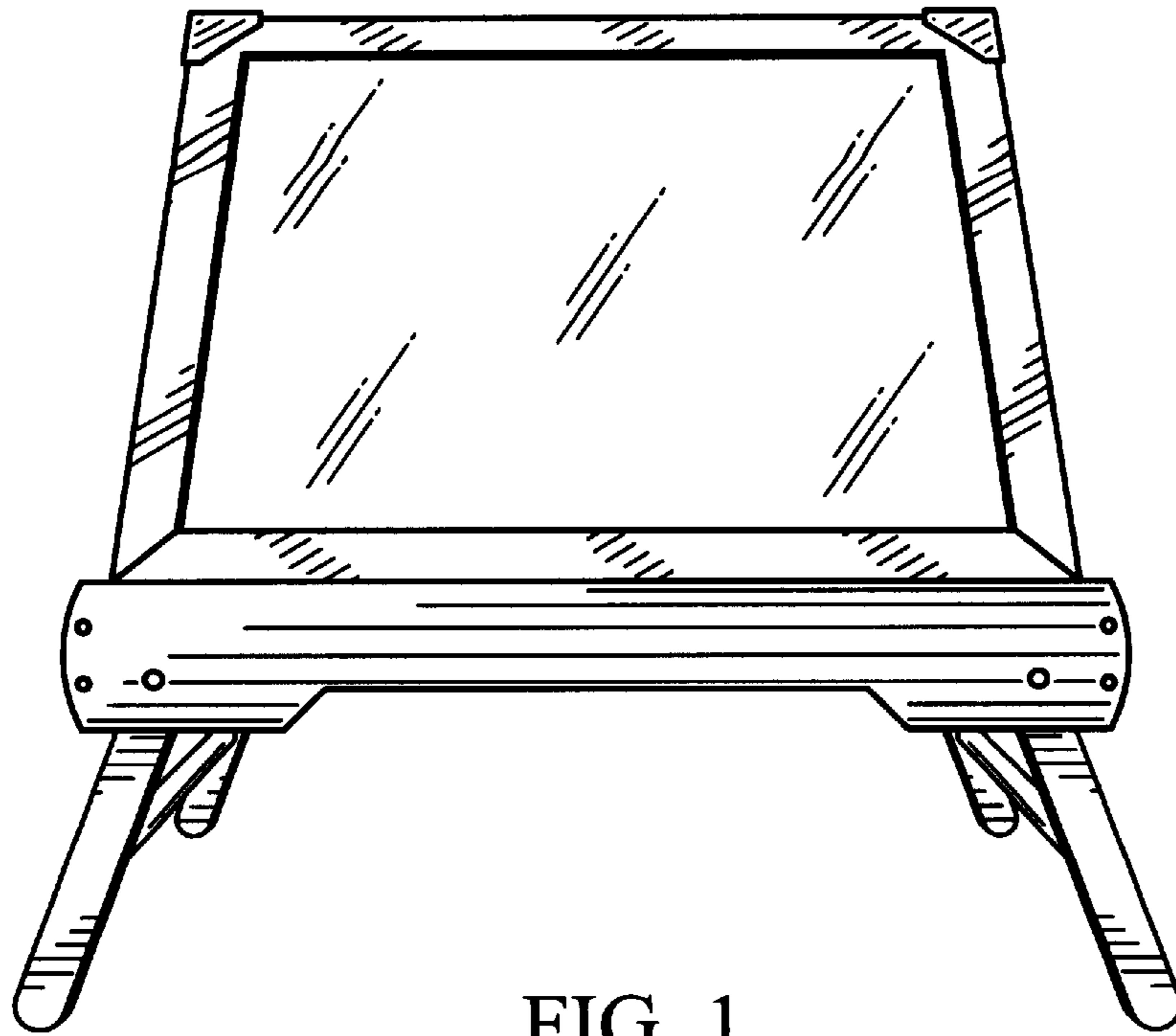

FIG. 1

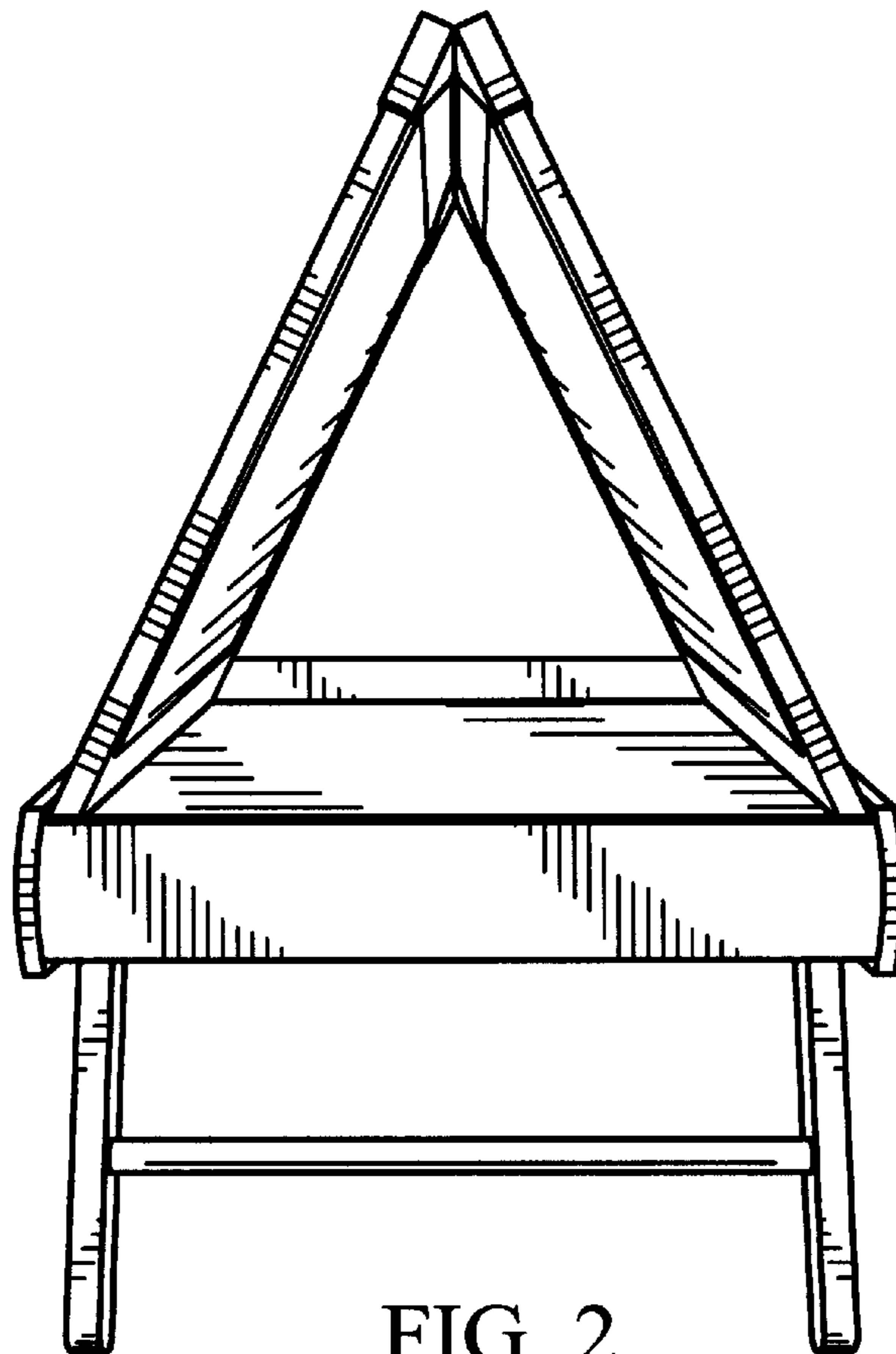

FIG. 2

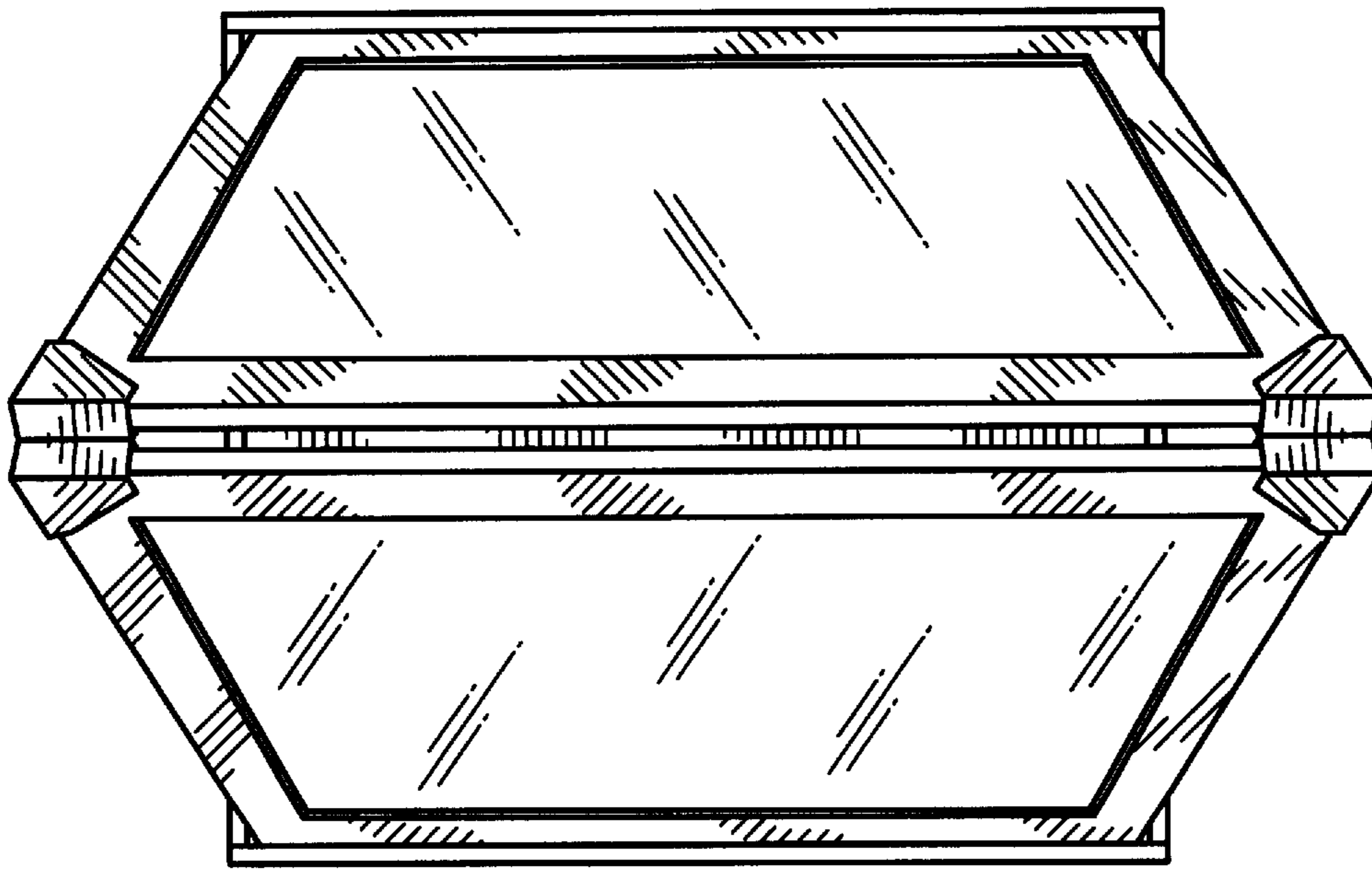

FIG. 3

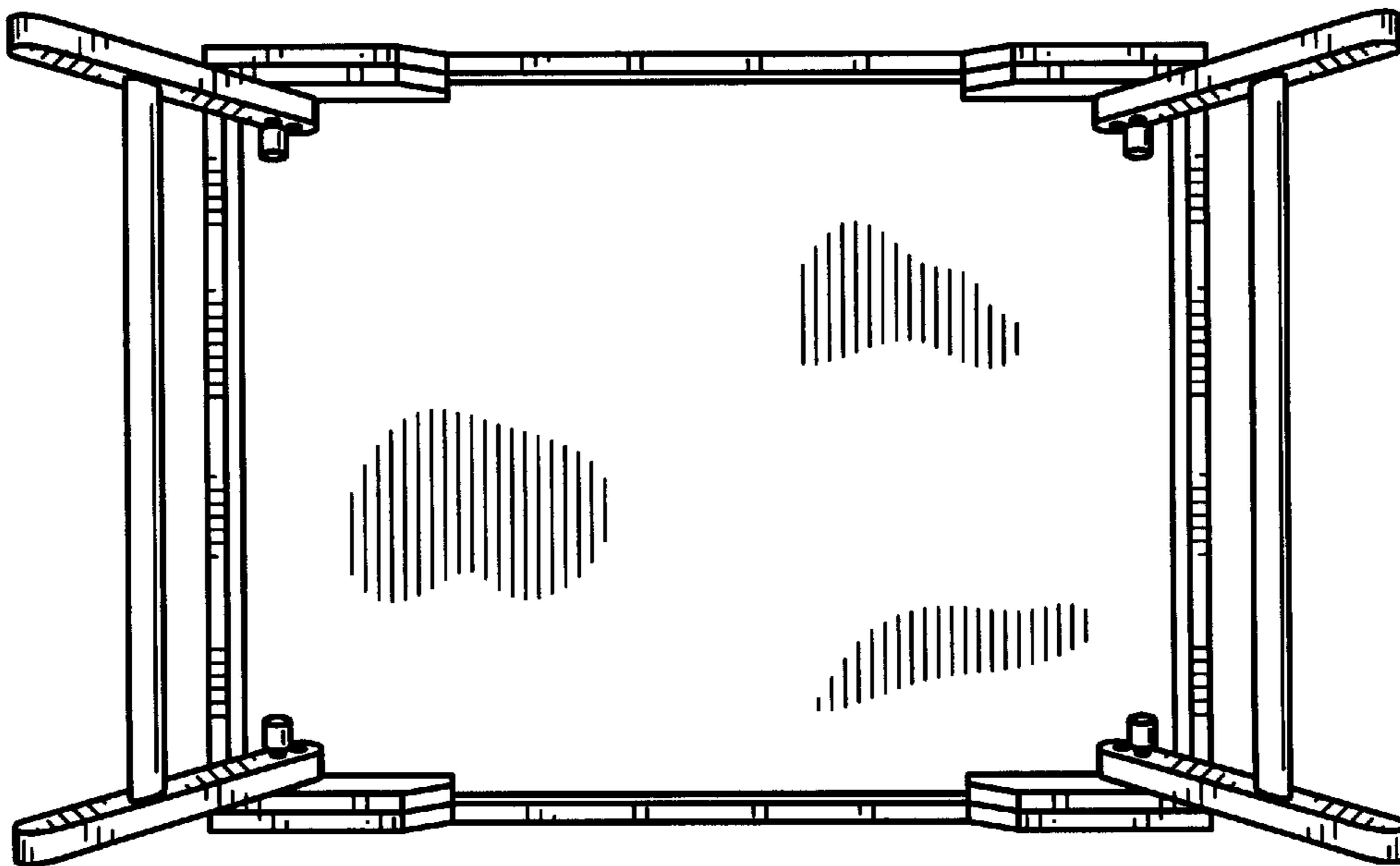

FIG. 4

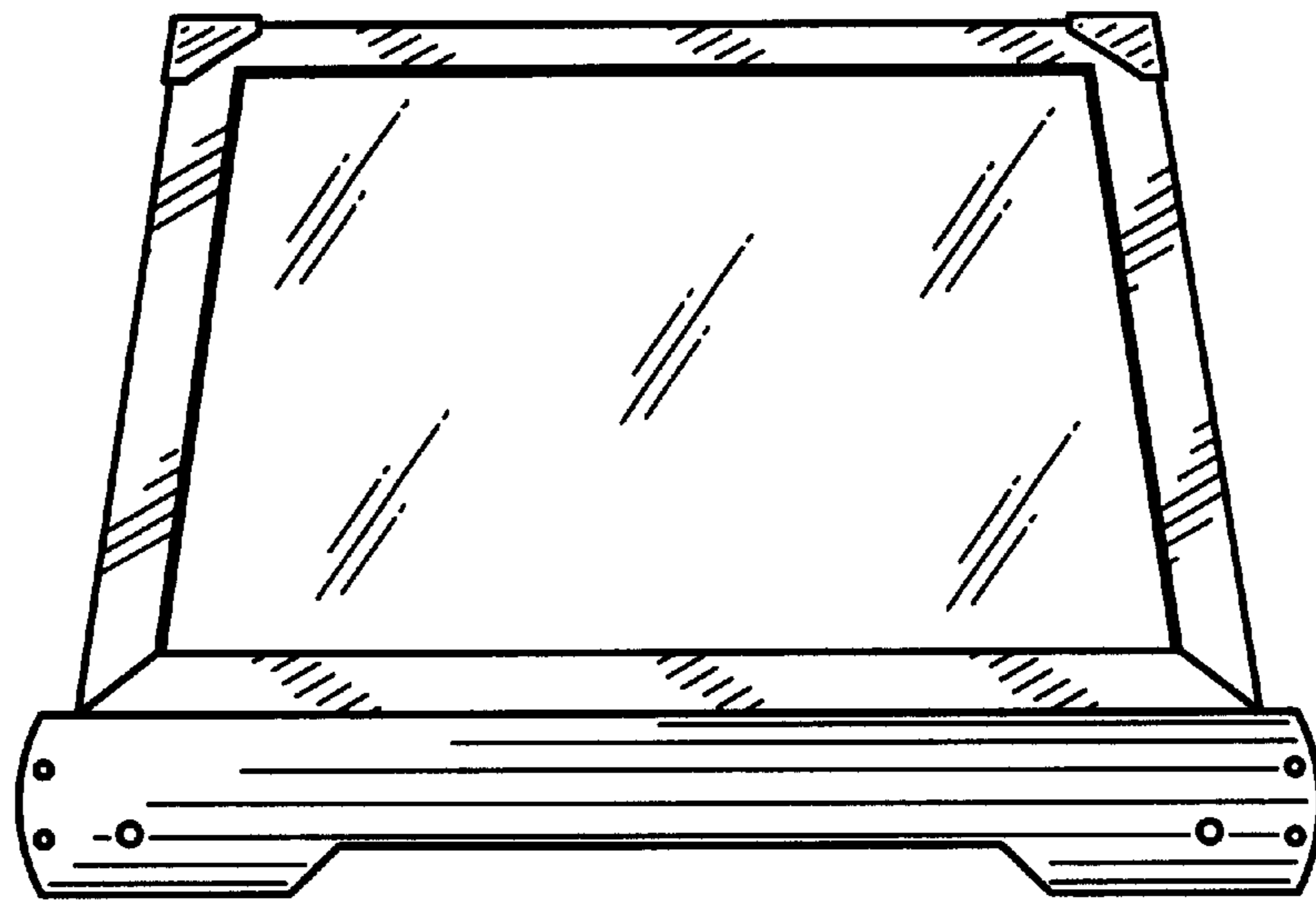

FIG. 5

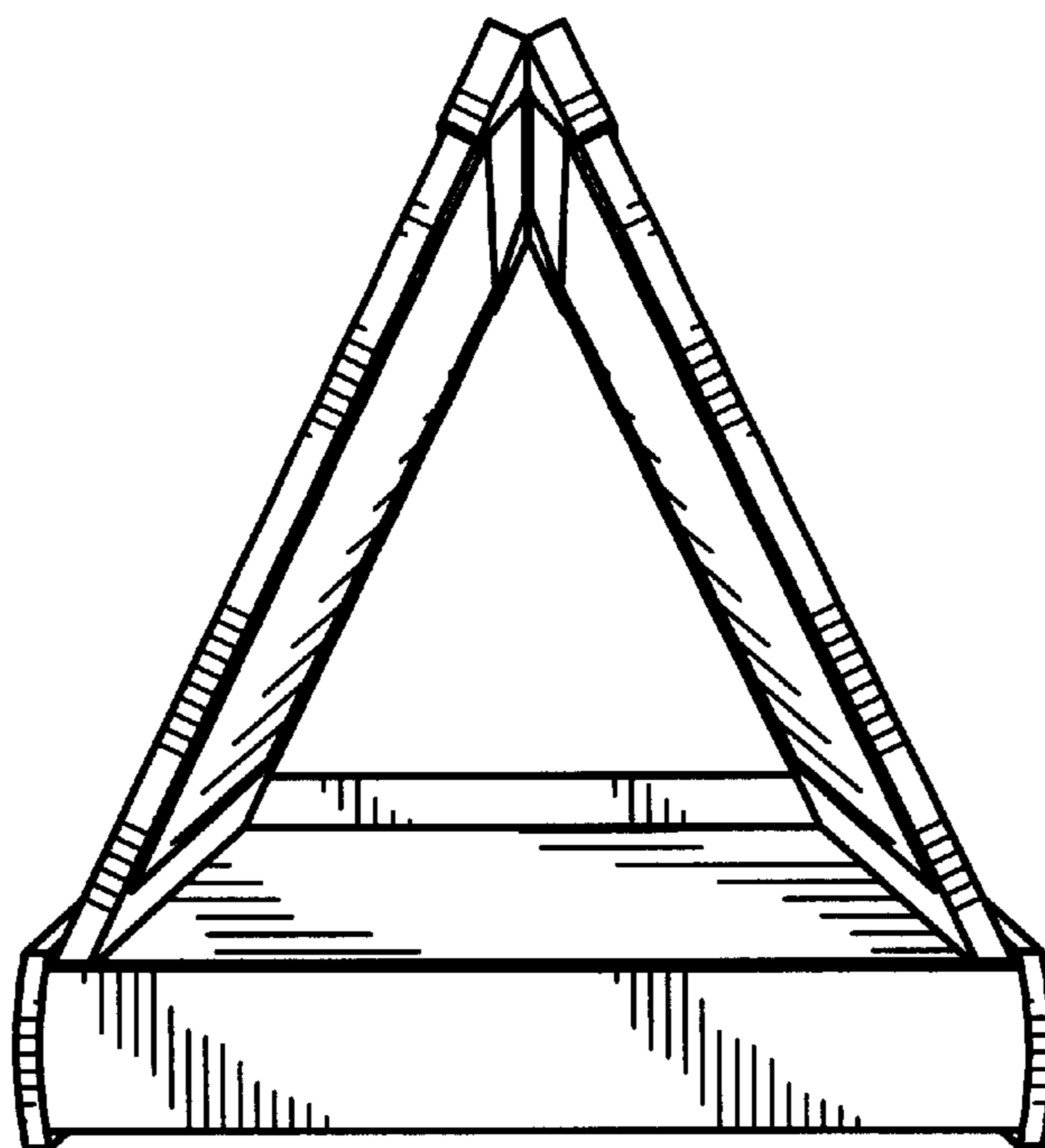

FIG. 6

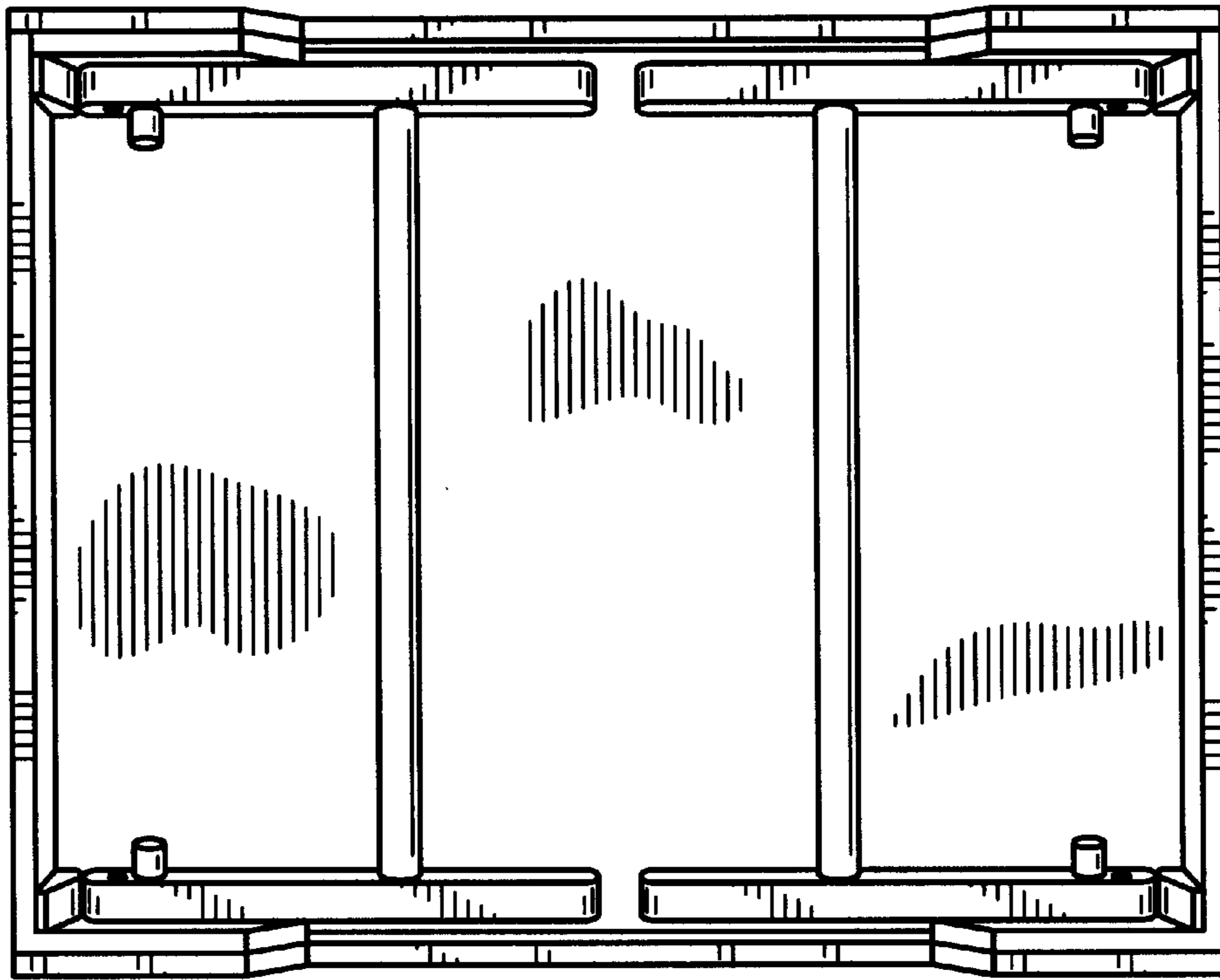

FIG. 7

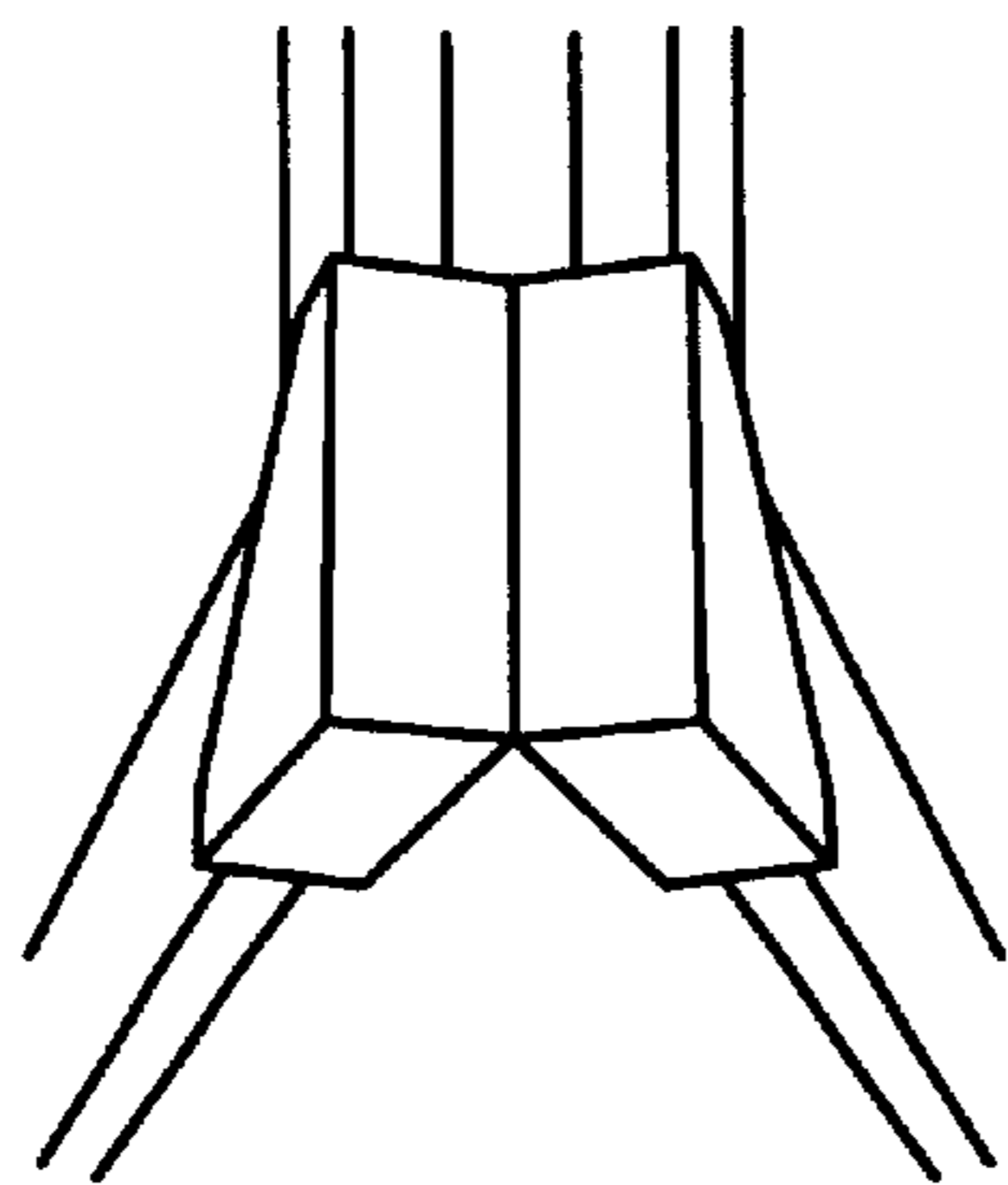

FIG. 8

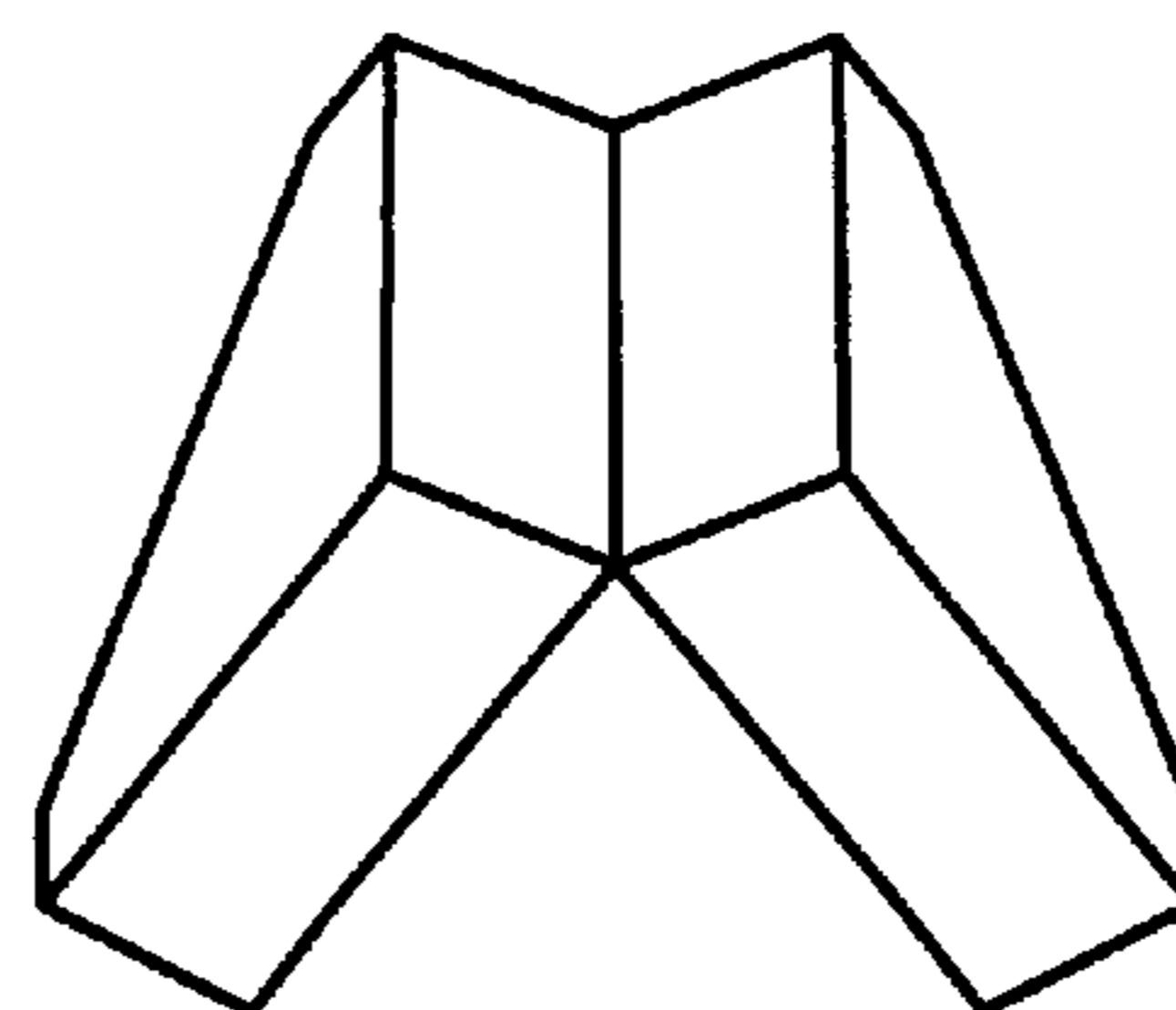

FIG. 9

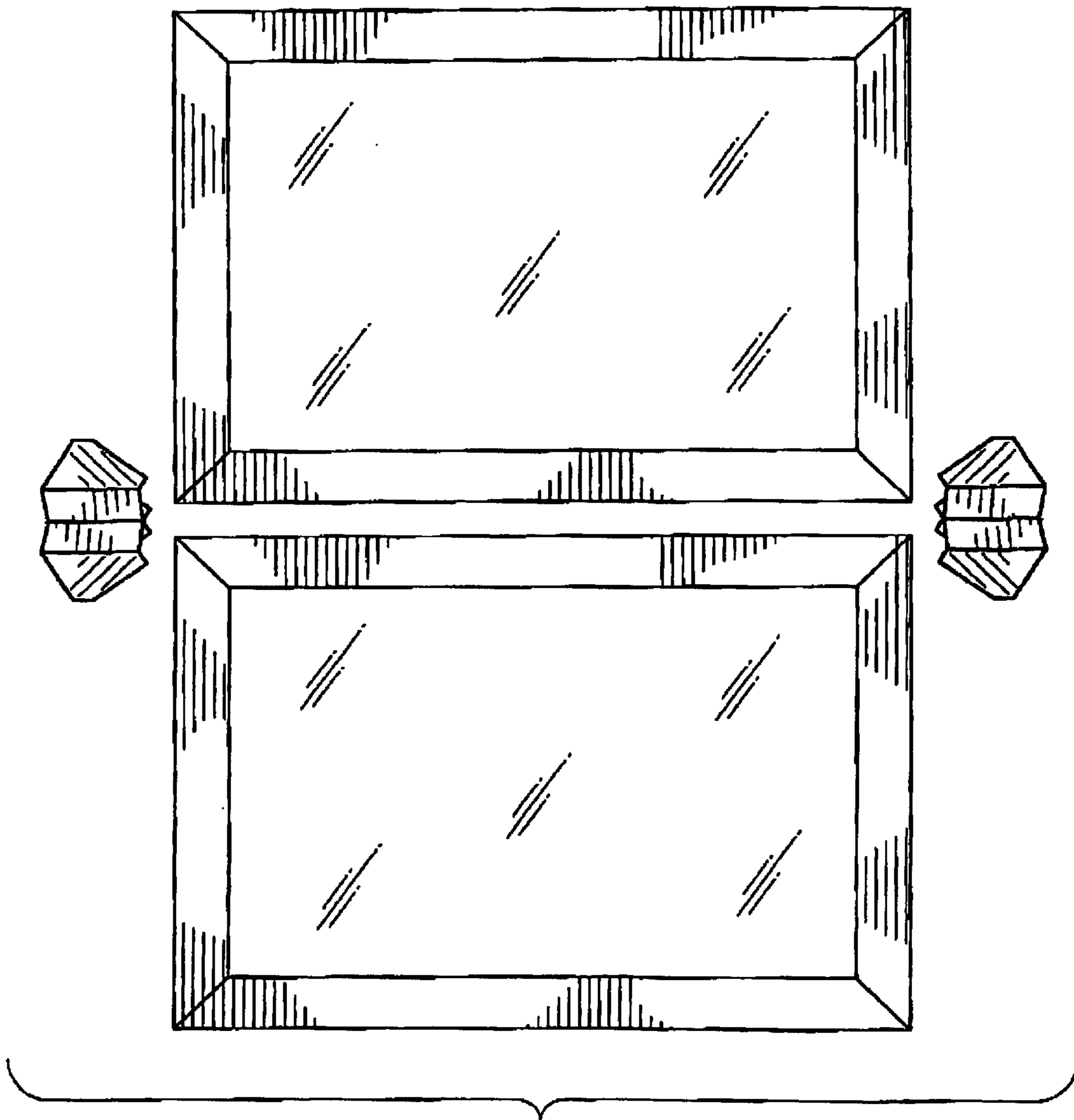

FIG. 10