



US00D533855S

(12) **United States Design Patent**  
**Rashid**

(10) **Patent No.:** **US D533,855 S**

(45) **Date of Patent:** **\*\* Dec. 19, 2006**

(54) **TELEVISION SET**

(75) Inventor: **Karim Rashid**, New York, NY (US)

(73) Assignee: **Hannspree, Inc.**, Taipei (TW)

(\*\*) Term: **14 Years**

(21) Appl. No.: **29/243,319**

(22) Filed: **Nov. 23, 2005**

(30) **Foreign Application Priority Data**

Aug. 2, 2005 (TW) ..... 94304621

(51) **LOC (8) Cl.** ..... **14-03**

(52) **U.S. Cl.** ..... **D14/126**

(58) **Field of Classification Search** ..... D14/125-134,  
D14/239, 371, 136, 374-377; 312/7.2; 348/836,  
348/838, 180, 184, 325, 739; 341/12; 248/917-924,  
248/465; 345/104, 133, 156, 168, 87, 173;  
720/605, 669, 600, 655; 369/99, 197; 455/344-347  
See application file for complete search history.

(56) **References Cited**

**U.S. PATENT DOCUMENTS**

D247,563 S \* 3/1978 Jinbo et al. .... D14/335

D267,880 S \* 2/1983 Marshall ..... D14/374  
D350,743 S \* 9/1994 Hicks et al. .... D14/130  
D407,074 S \* 3/1999 Lee ..... D14/375  
D419,967 S \* 2/2000 Louis et al. .... D14/340  
D445,785 S \* 7/2001 Van Scoyoc et al. .... D14/340  
D461,184 S \* 8/2002 Chen ..... D14/336

\* cited by examiner

*Primary Examiner*—Raphael Barkai

(74) *Attorney, Agent, or Firm*—Birch, Stewart, Kolasch & Birch, LLP

(57) **CLAIM**

The ornamental design for a television set, as shown and described.

**DESCRIPTION**

FIG. 1 is a front perspective view thereof;  
FIG. 2 is a front elevational view thereof;  
FIG. 3 is a rear elevational view thereof;  
FIG. 4 is a left side elevational view thereof;  
FIG. 5 is a right side elevational view thereof;  
FIG. 6 is a top plan view thereof; and,  
FIG. 7 is a bottom plan view thereof.

**1 Claim, 7 Drawing Sheets**

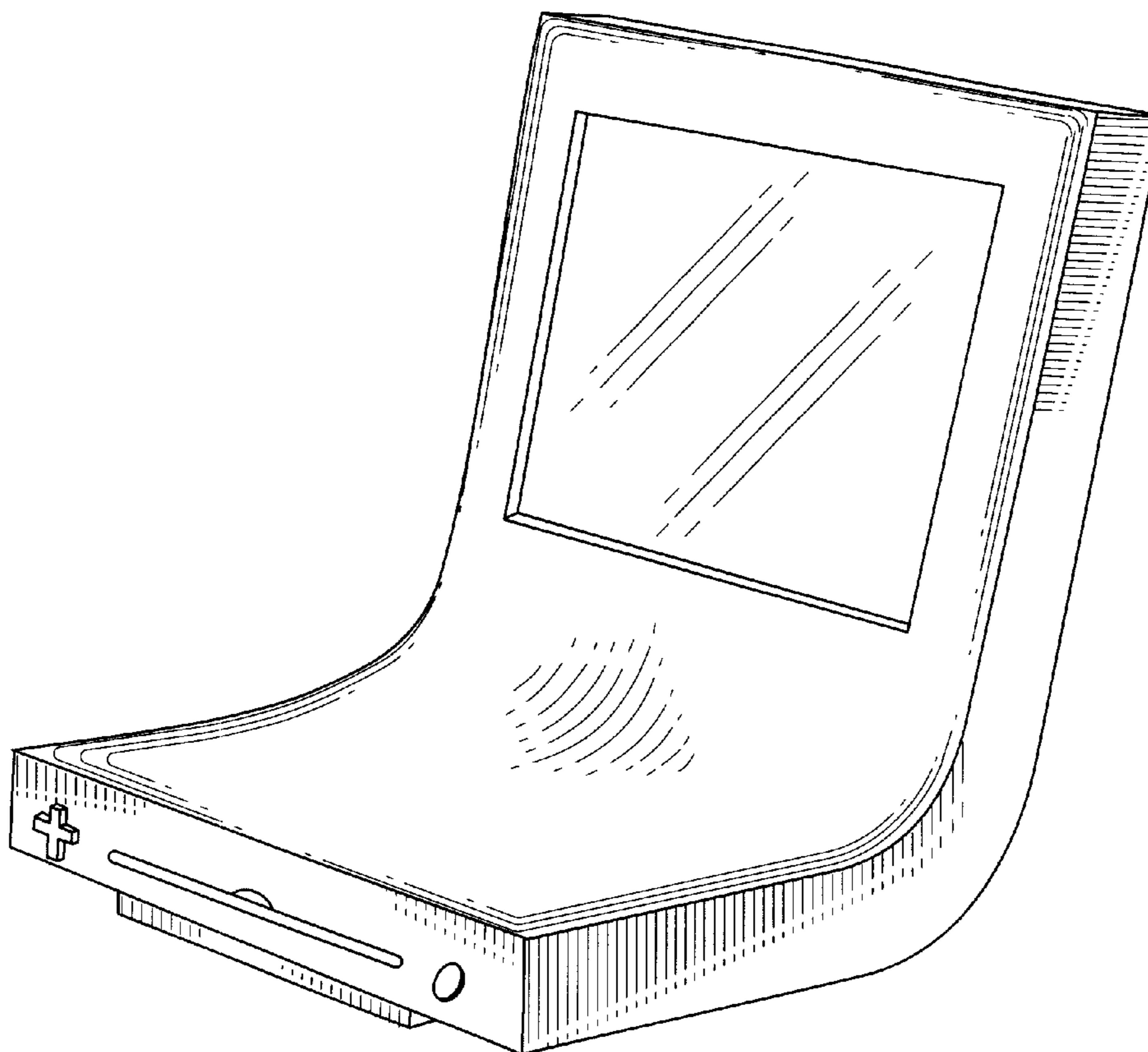

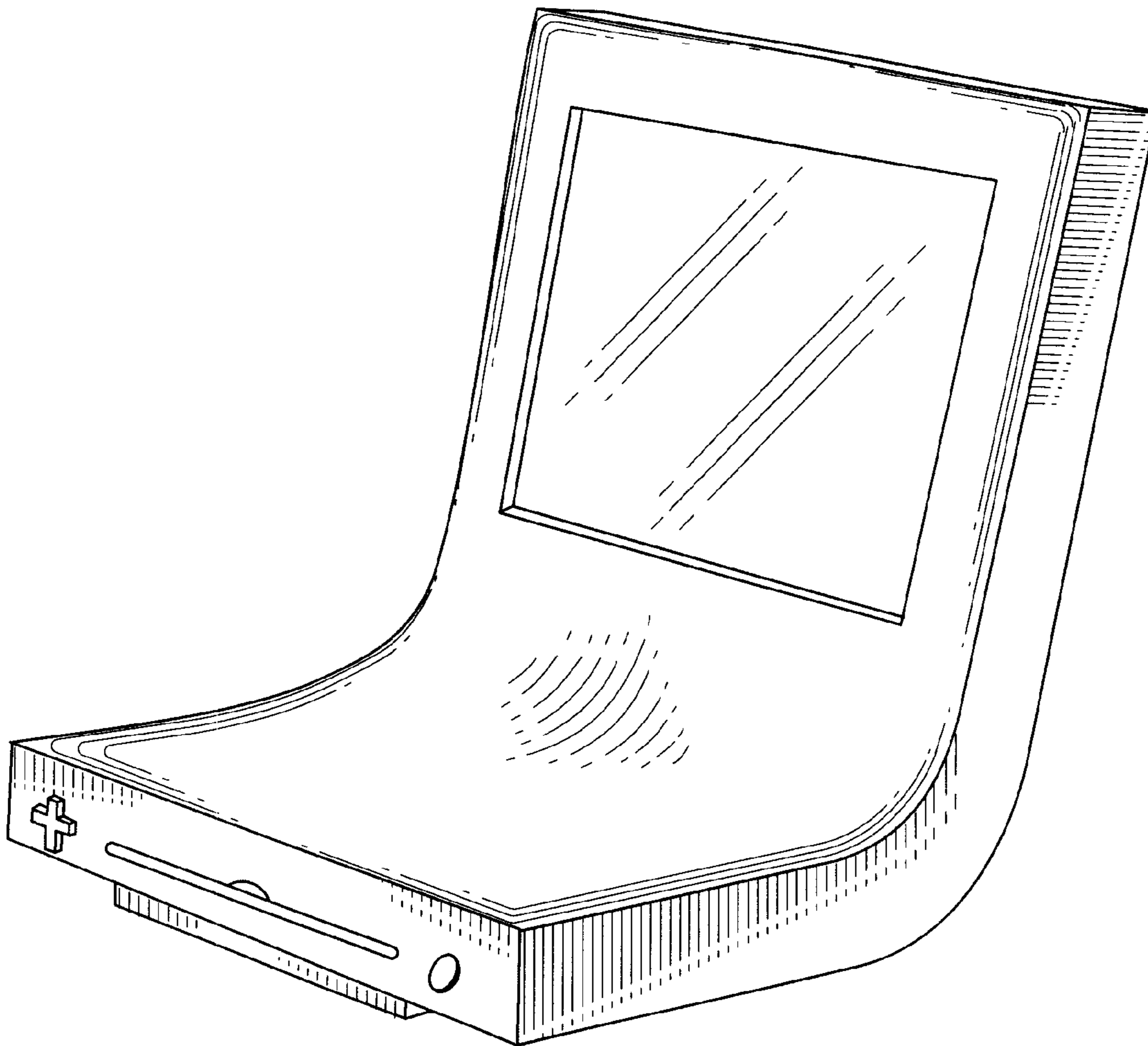

FIG. 1

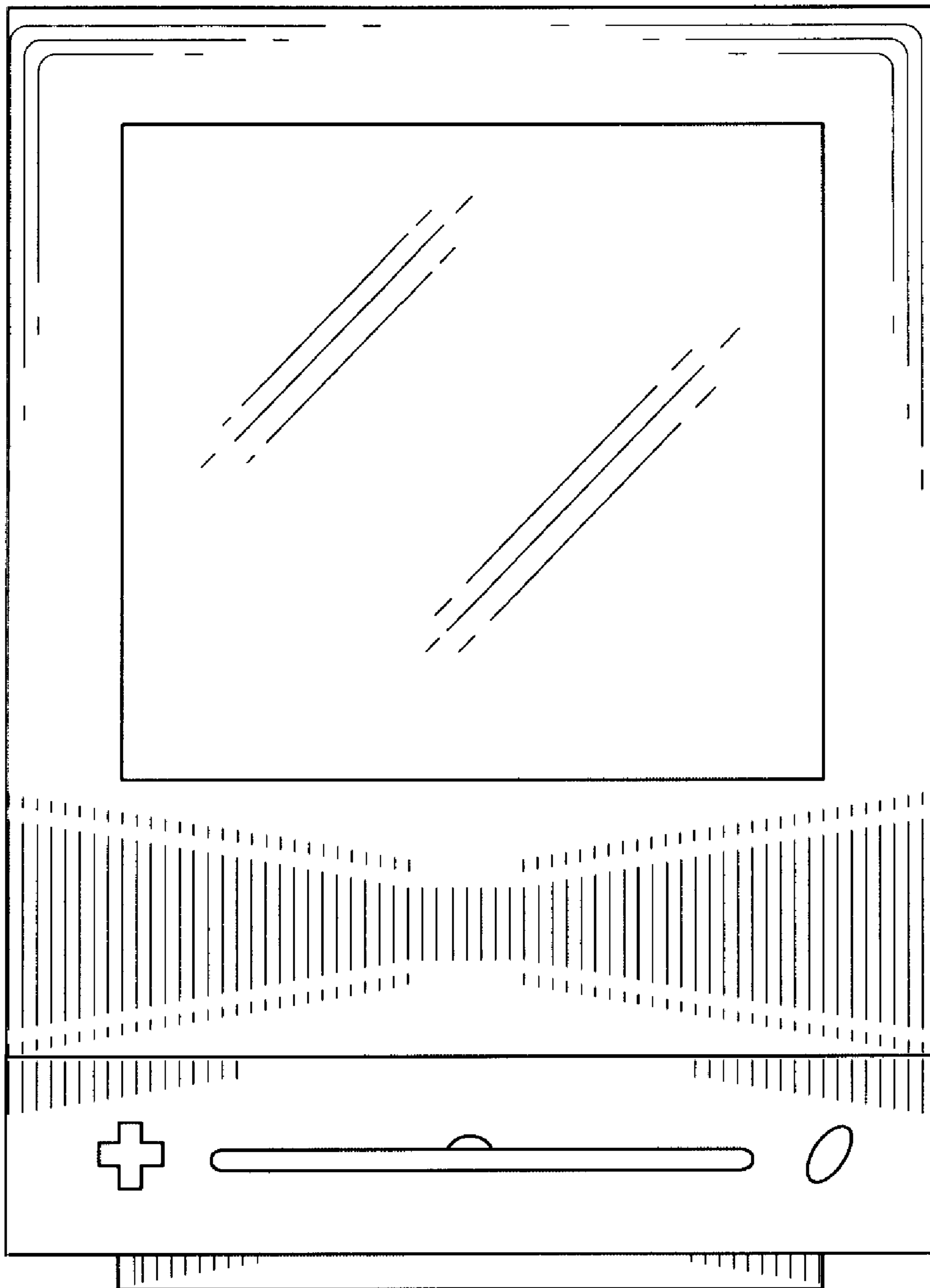

FIG. 2

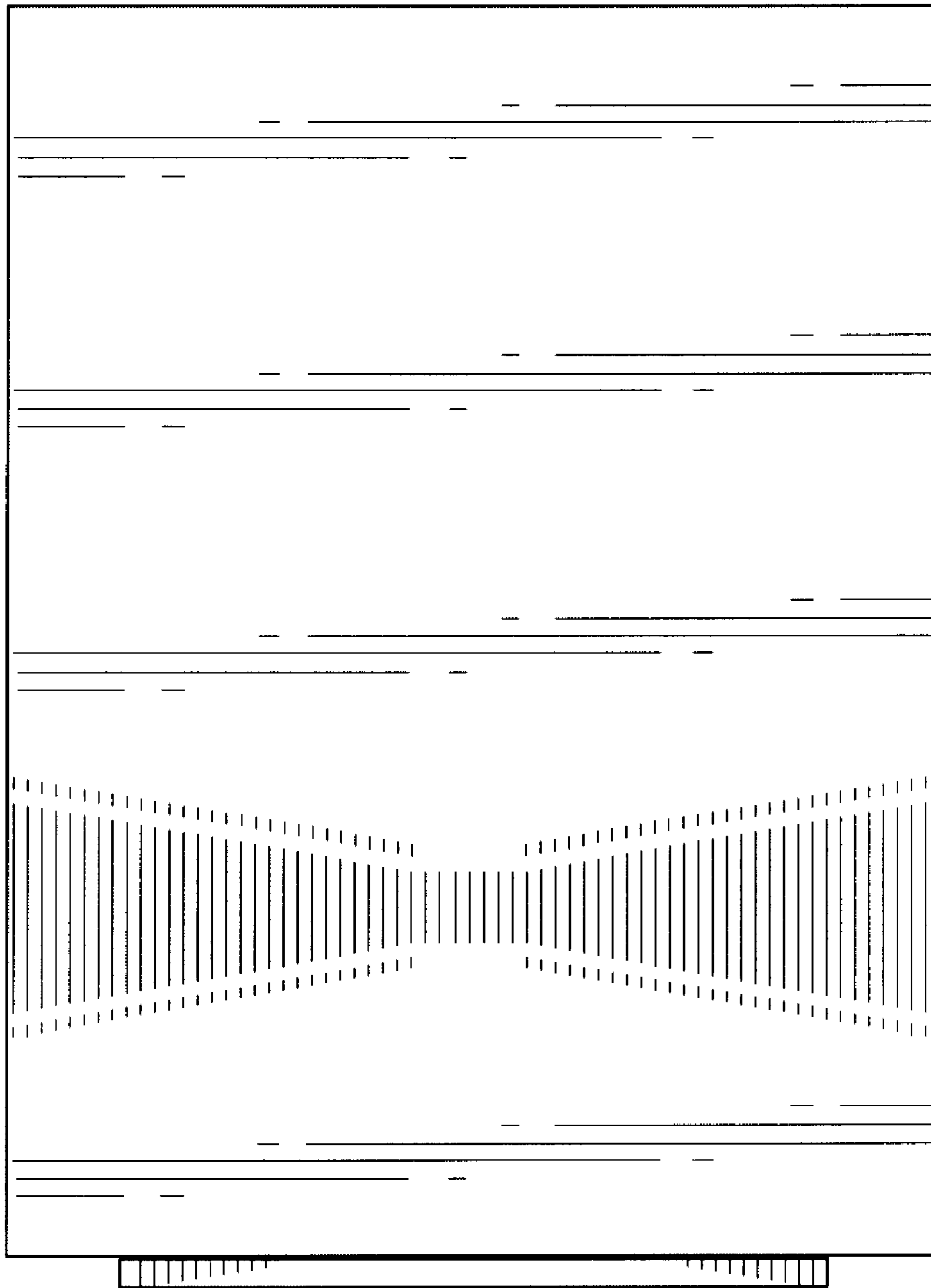

FIG. 3

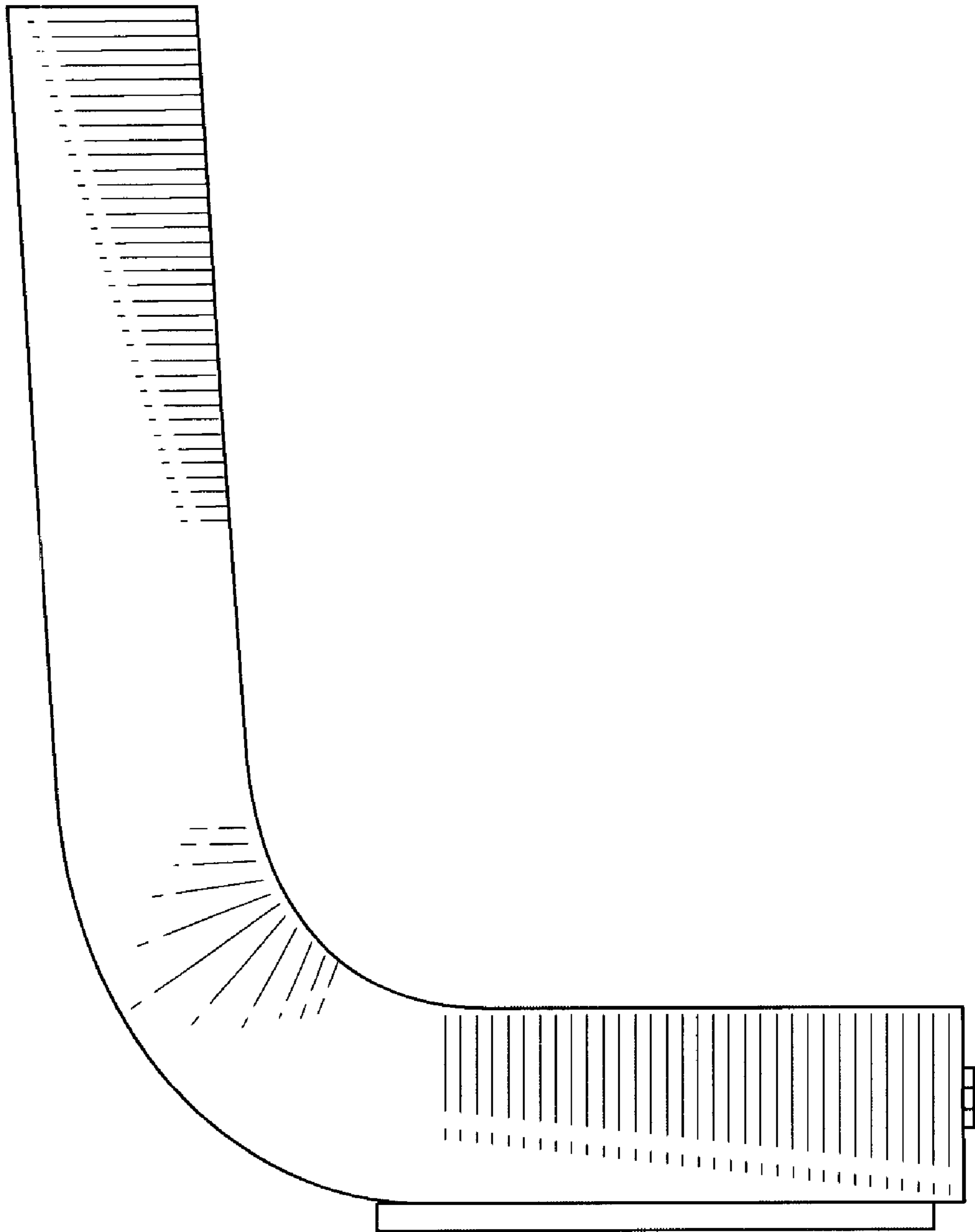

FIG. 4

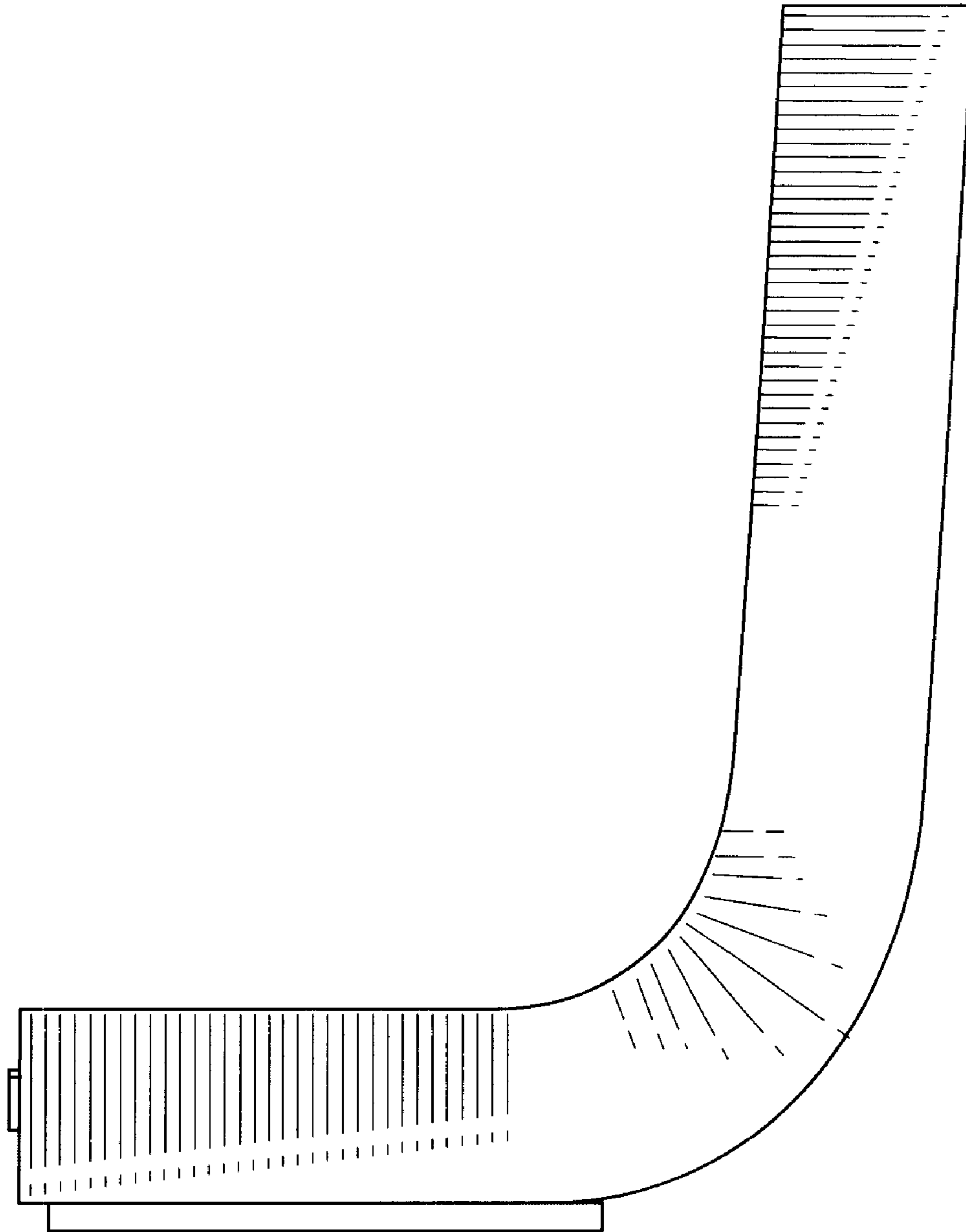

FIG. 5

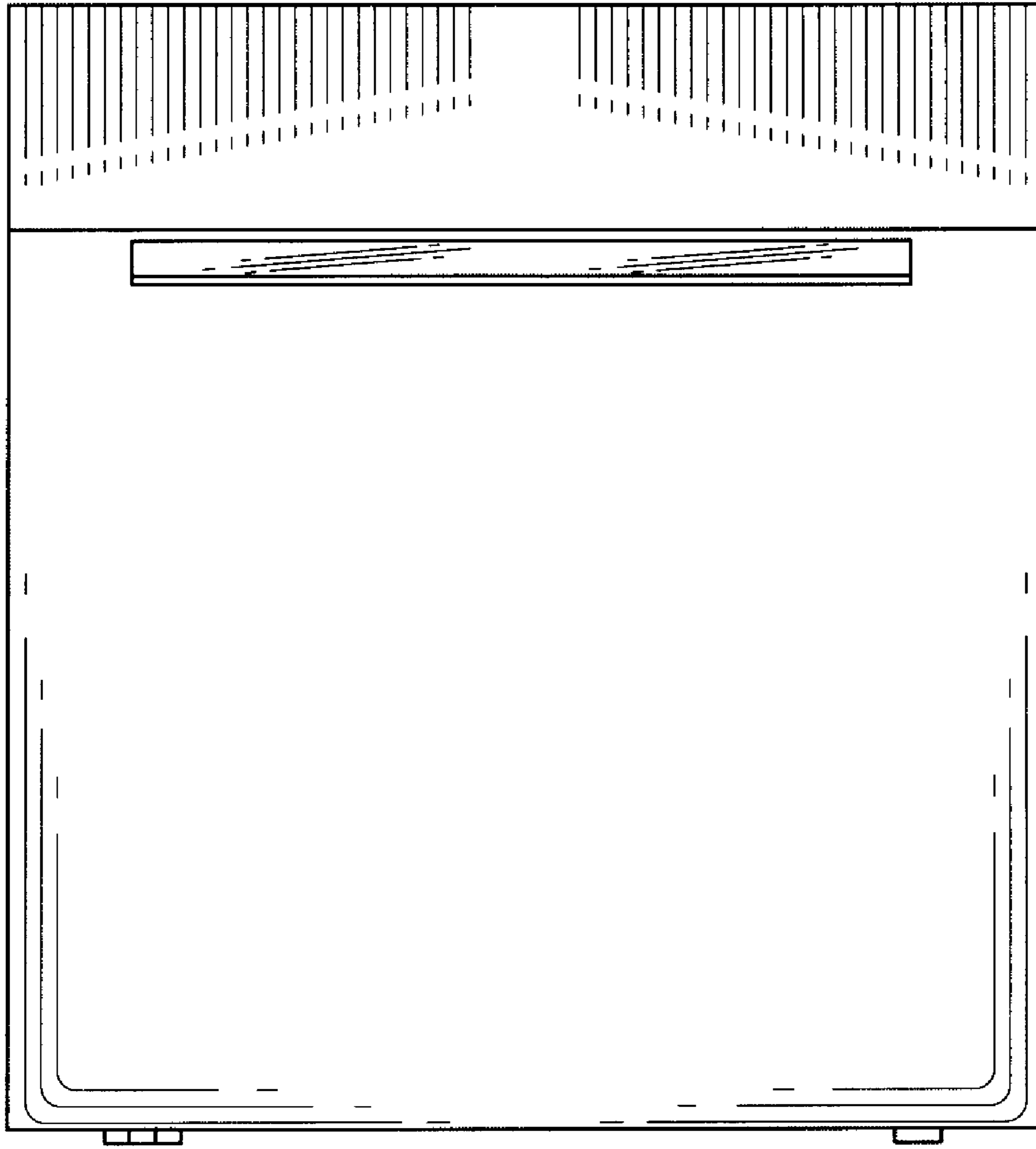

FIG. 6

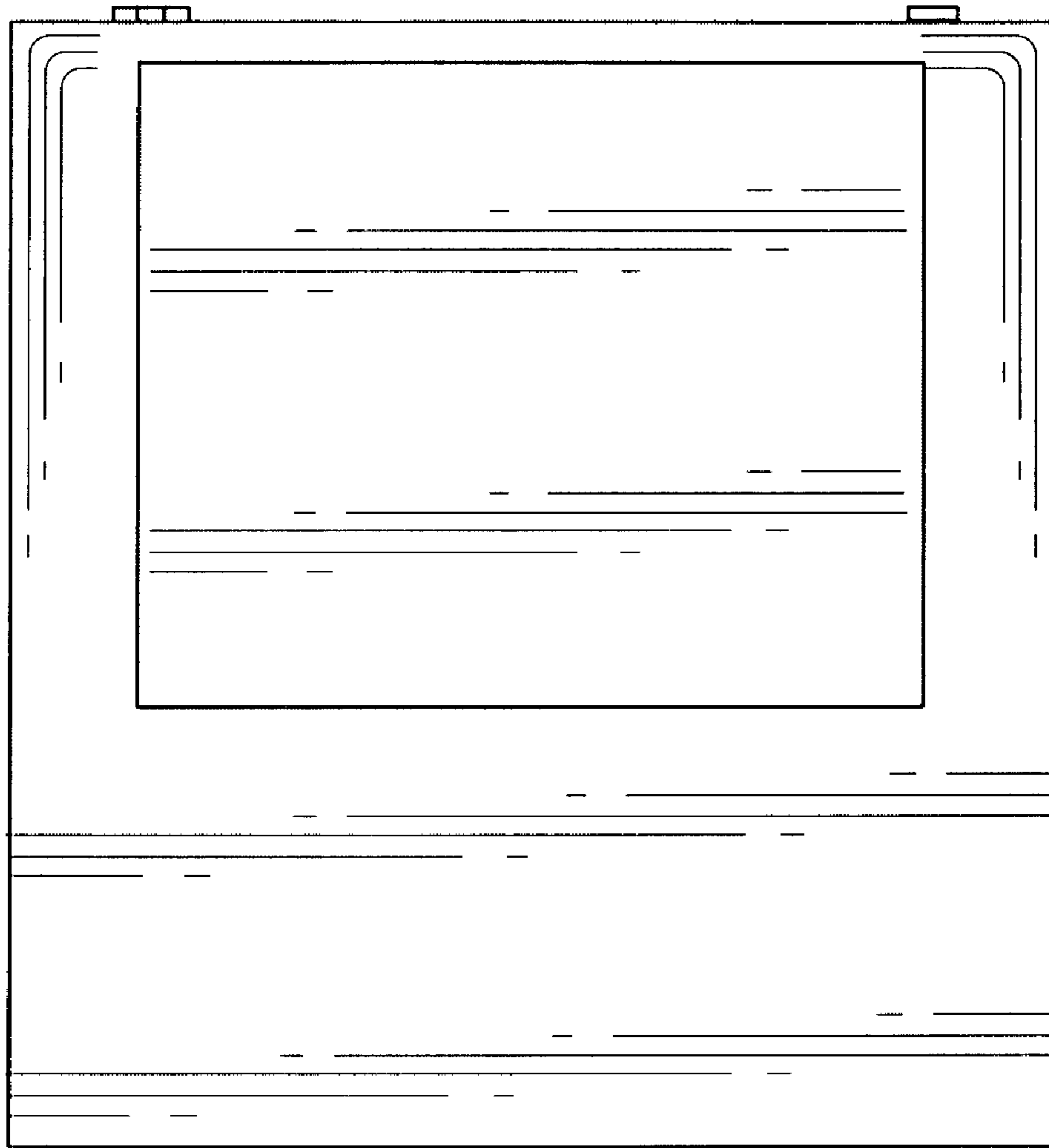

FIG. 7