



US00D533808S

(12) **United States Design Patent**
Anscher

(10) **Patent No.:** **US D533,808 S**

(45) **Date of Patent:** **** Dec. 19, 2006**

(54) **MALE BUCKLE PORTION**

D519,878 S * 5/2006 Anscher D11/216

(76) Inventor: **Joseph Anscher**, 1928 Midlane,
Muttontown, NY (US) 11791

* cited by examiner

(**) Term: **14 Years**

Primary Examiner—Ralf Seifert
(74) *Attorney, Agent, or Firm*—Collard & Roe, P.C.

(21) Appl. No.: **29/202,947**

(57) **CLAIM**

(22) Filed: **Apr. 7, 2004**

The ornamental design for a male buckle portion, as shown and described.

(51) **LOC (8) Cl.** **02-07**

DESCRIPTION

(52) **U.S. Cl.** **D11/216**

(58) **Field of Classification Search** D11/200,
D11/201, 208–210, 212–218, 220, 230–234,
D11/236–237, 86–87, 94; 63/15.2, 15; 24/307,
24/625, 616, 200, 196, 171, 169, 112, 614,
24/615

FIG. 1 shows a perspective view of my design for a male buckle portion according to the invention;
FIG. 2 shows a top view thereof;
FIG. 3 shows a side view thereof, with the opposite side view being a mirror image thereof;
FIG. 4 shows a bottom view thereof;
FIG. 5 shows a front end view thereof; and,
FIG. 6 shows a rear end view thereof.

See application file for complete search history.

(56) **References Cited**

U.S. PATENT DOCUMENTS

D496,303 S * 9/2004 Anscher D11/216

1 Claim, 3 Drawing Sheets

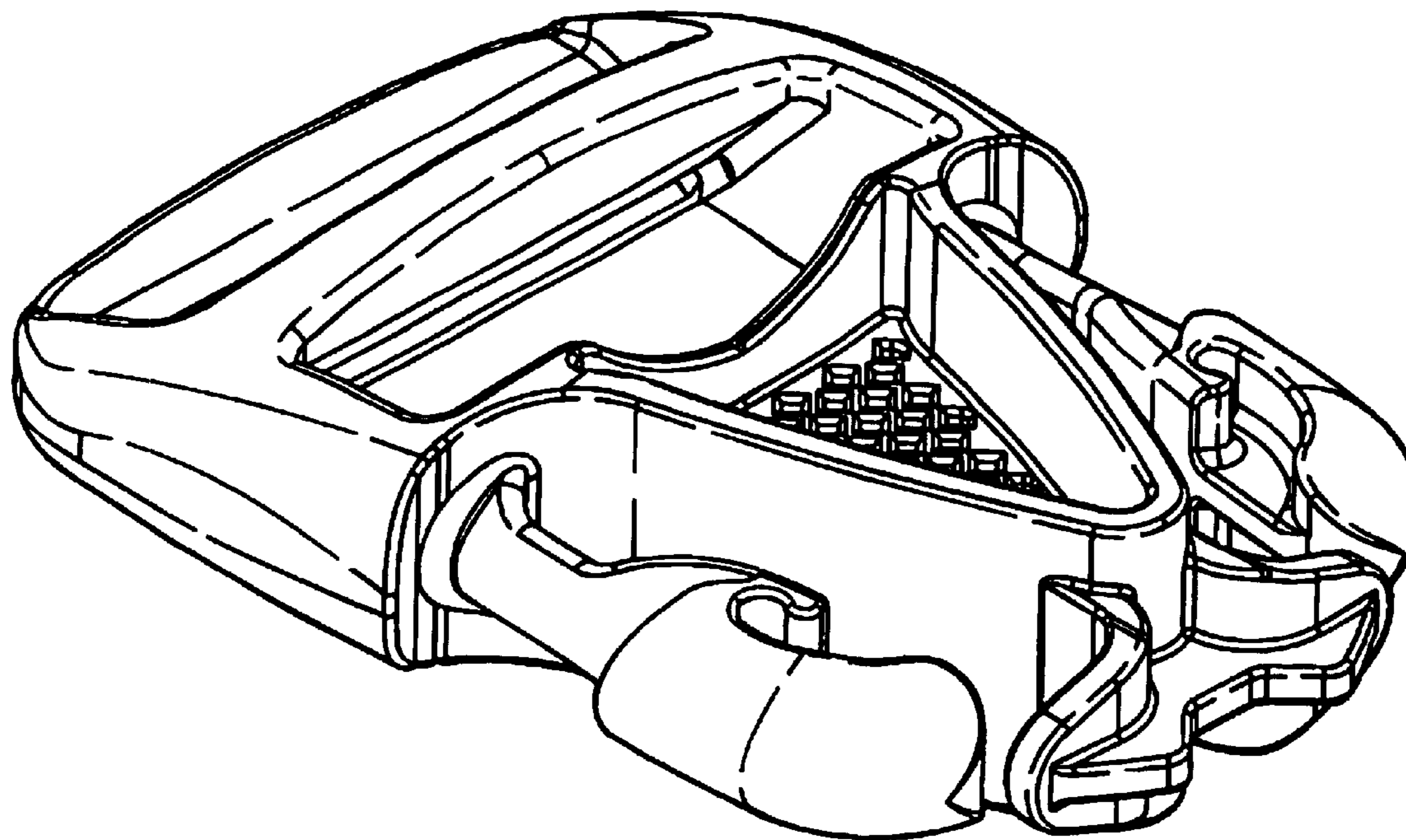

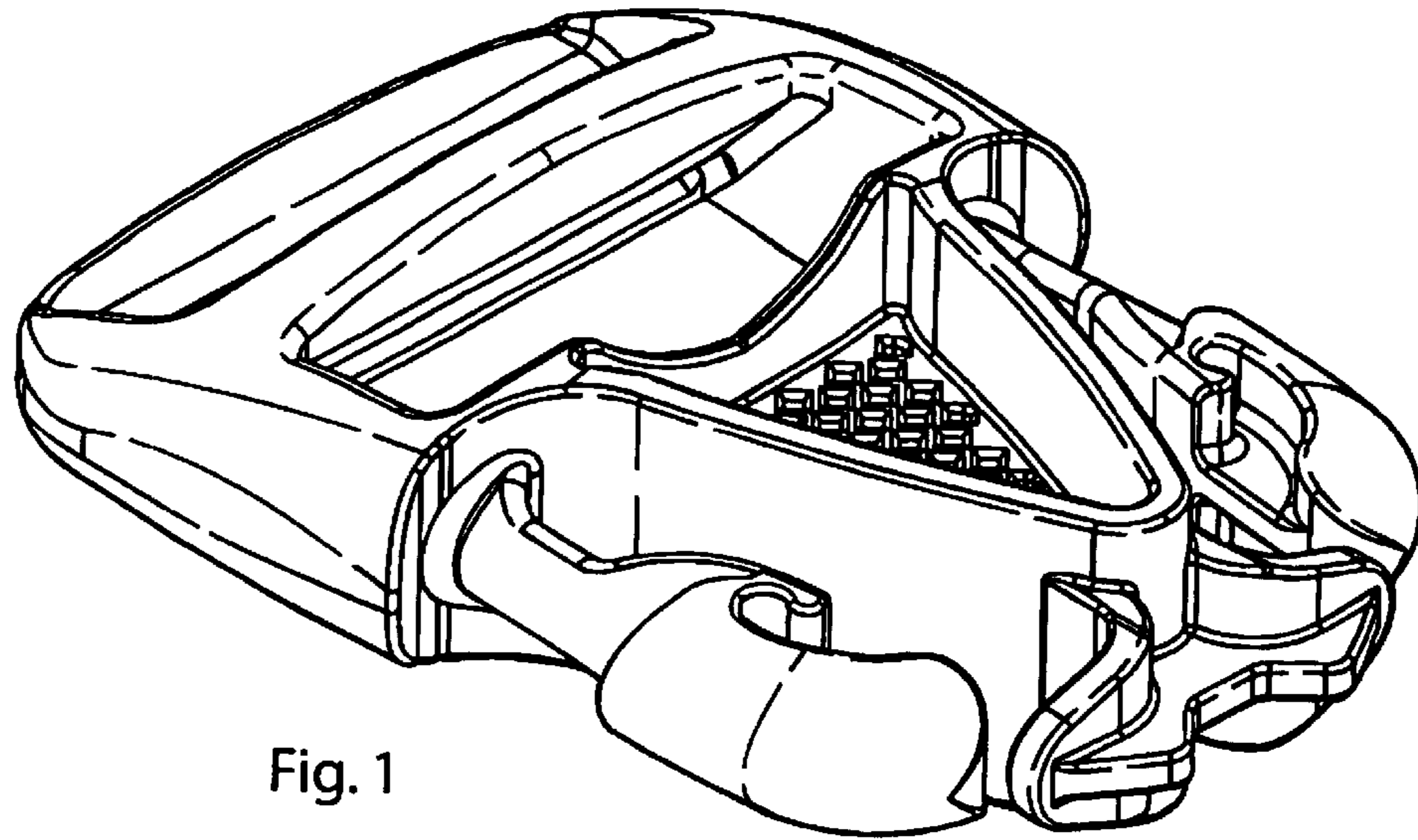

Fig. 1

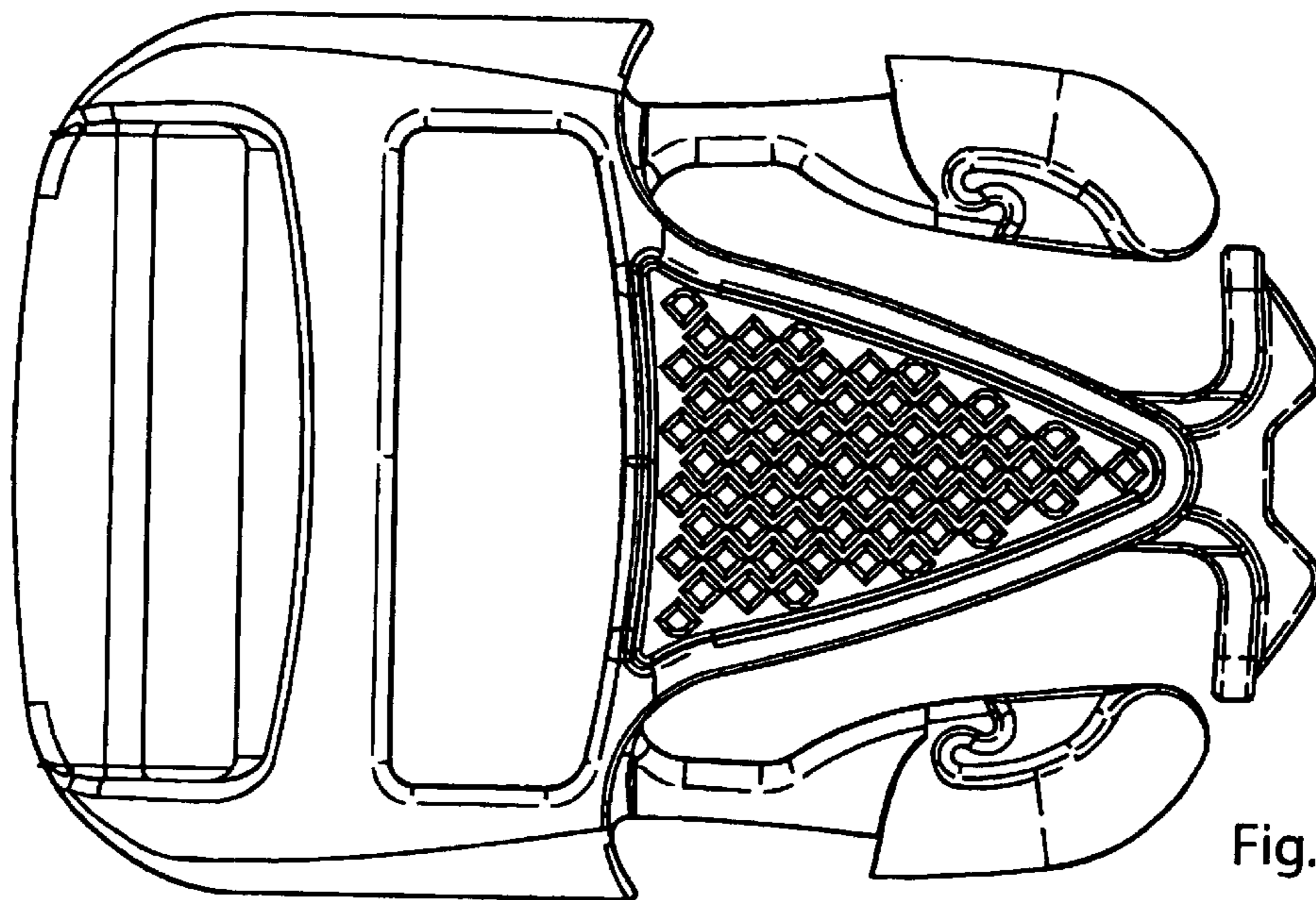

Fig. 2

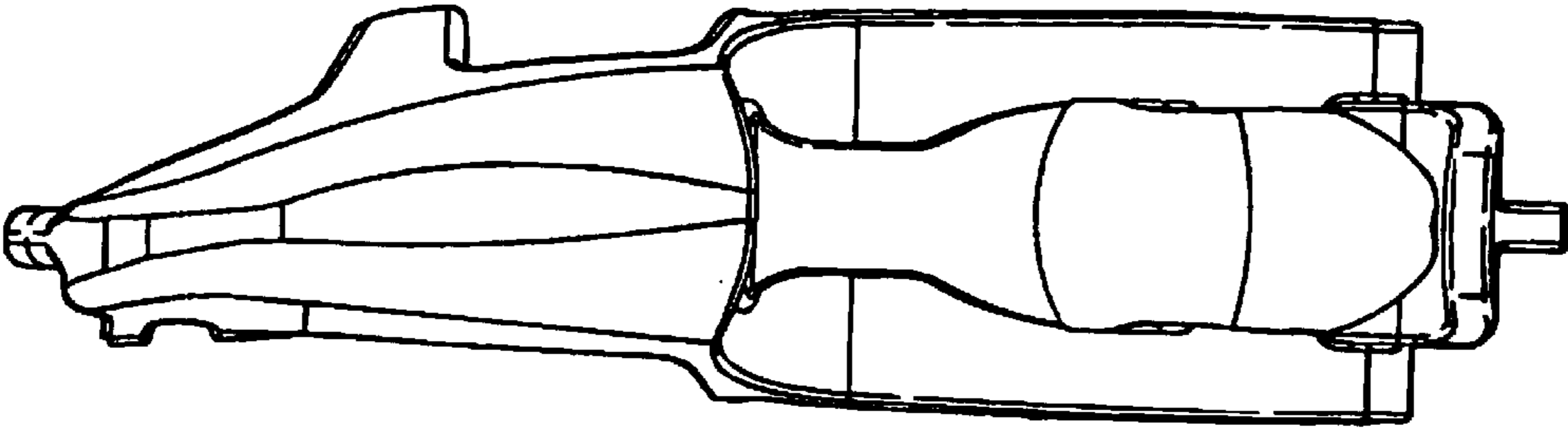

Fig. 3

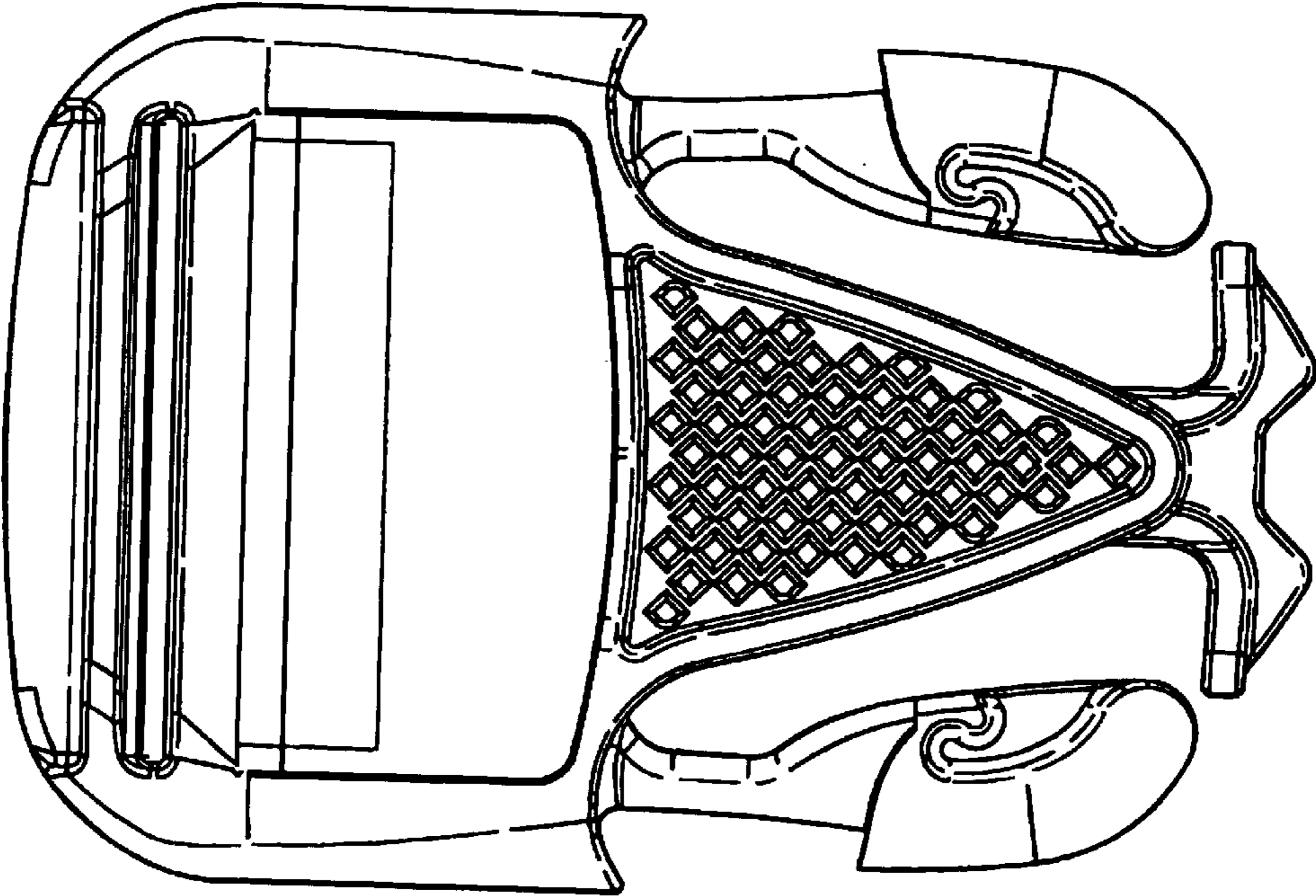

Fig. 4

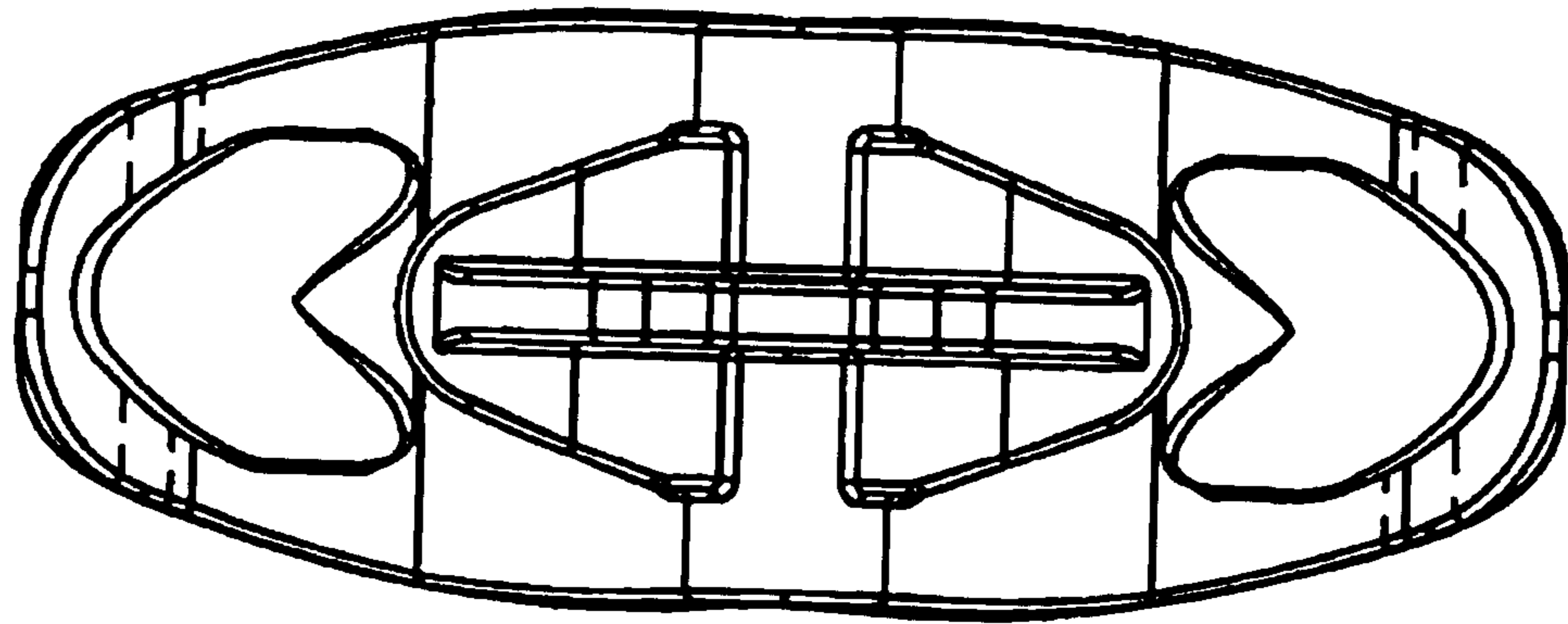

Fig. 5

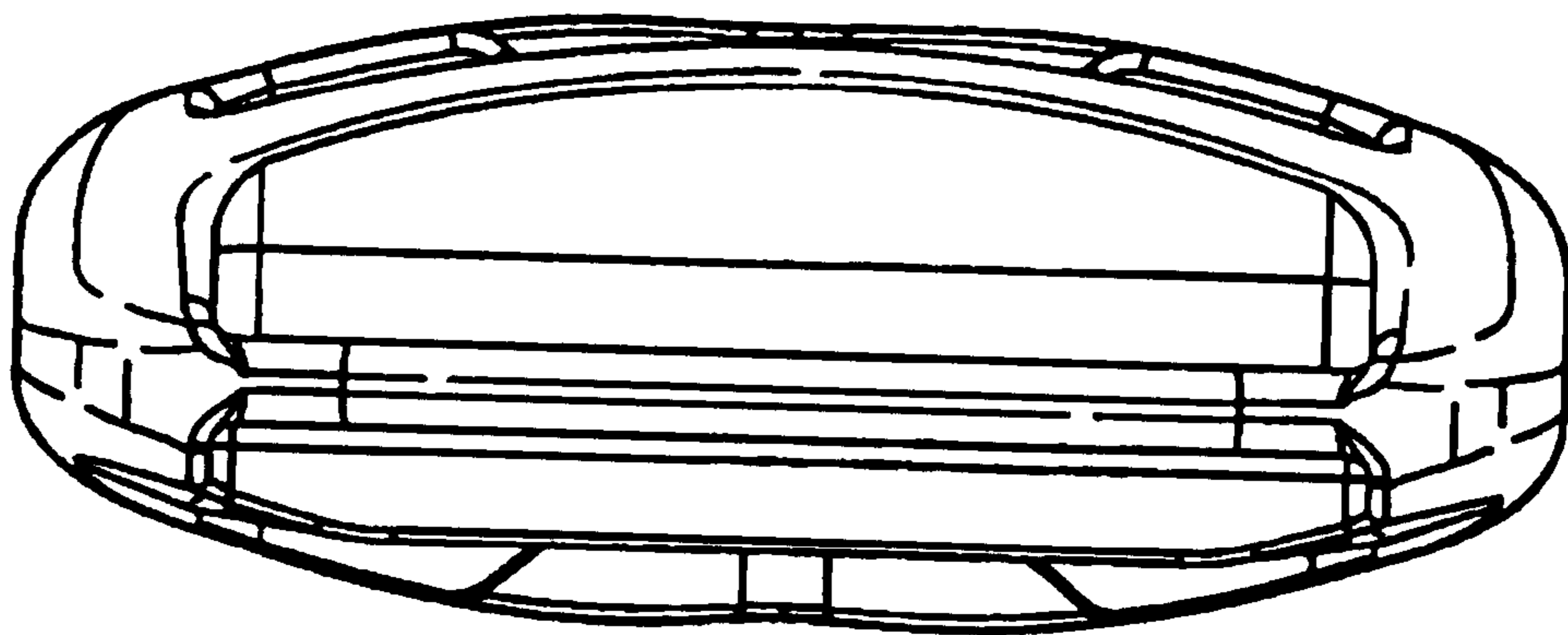

Fig. 6