



US00D533740S

(12) **United States Design Patent**
Dombrowski et al.

(10) **Patent No.:** **US D533,740 S**

(45) **Date of Patent:** **** Dec. 19, 2006**

(54) **CADDY**

(75) Inventors: **David Dombrowski**, Madison, CT
(US); **Chris Switalski**, Suffield, UT
(US); **Winston Wu**, Guang Dong (CN)

(73) Assignee: **Eveready Battery Company, Inc.**, St.
Louis, MO (US)

(**) Term: **14 Years**

(21) Appl. No.: **29/214,562**

(22) Filed: **Oct. 5, 2004**

(51) **LOC (8) Cl.** **06-04**

(52) **U.S. Cl.** **D6/526; D8/373**

(58) **Field of Classification Search** D8/373,
D8/363; D6/526; 248/309.1; 211/70.6, 13.1,
211/87.01

See application file for complete search history.

(56) **References Cited**

U.S. PATENT DOCUMENTS

2,845,245 A * 7/1958 Gray et al. 248/314

D370,375 S * 6/1996 Murgida et al. D6/526
D464,222 S * 10/2002 Coffin et al. D6/526
D481,237 S * 10/2003 Wakayama D6/526

* cited by examiner

Primary Examiner—Holly Baynham

(74) *Attorney, Agent, or Firm*—Michaud-Duffy Group LLP

(57) **CLAIM**

We claim the new, original and ornamental design for a caddy, as shown and described.

DESCRIPTION

FIG. 1 is a front perspective view of the caddy,
FIG. 2 is a top view of the caddy,
FIG. 3 is a front view of the caddy,
FIG. 4 is a bottom view of the caddy,
FIG. 5 is a left hand side view of the caddy,
FIG. 6 is a right hand side view of the caddy; and,
FIG. 7 is a rear view of the caddy.

1 Claim, 1 Drawing Sheet

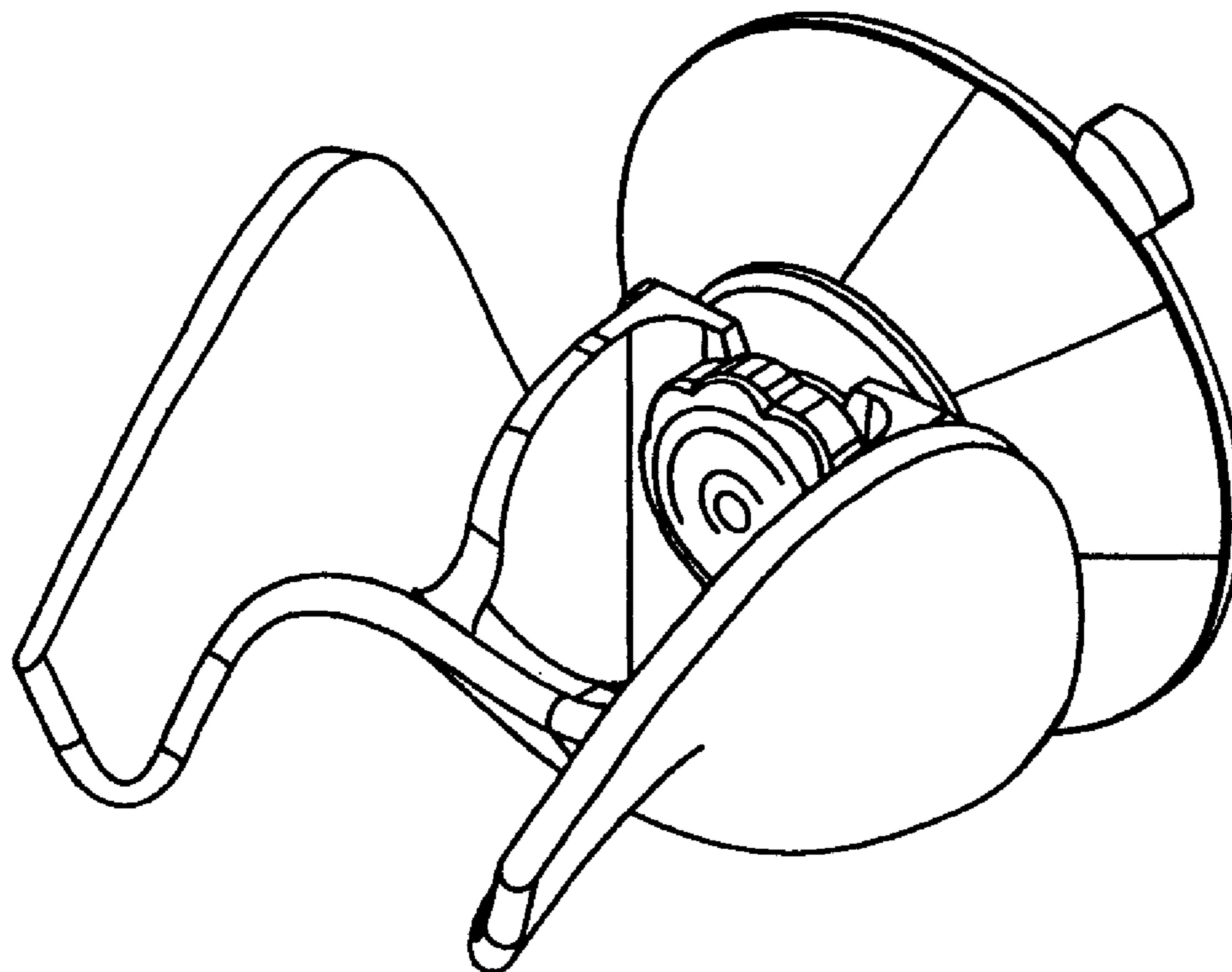

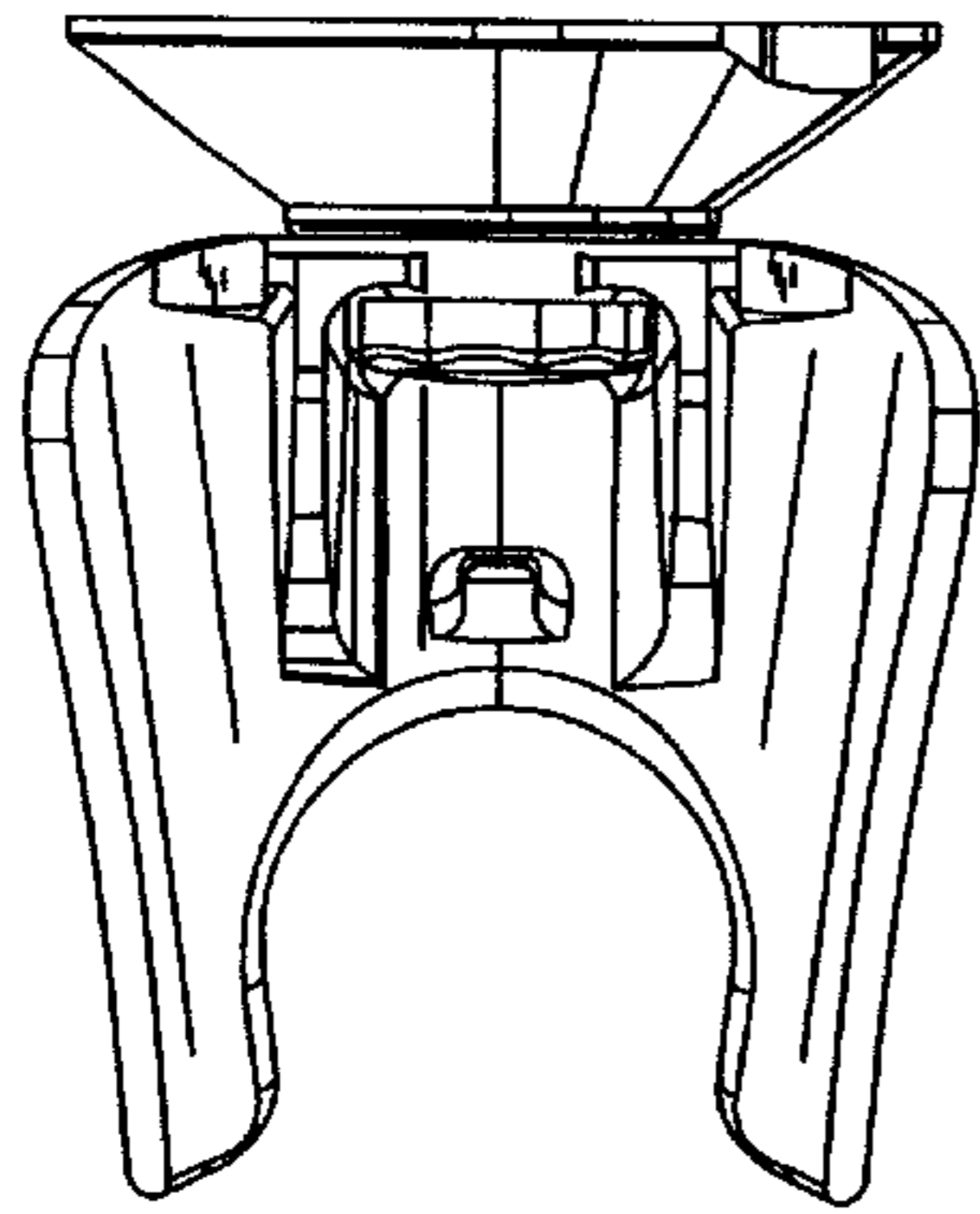

FIG. 2

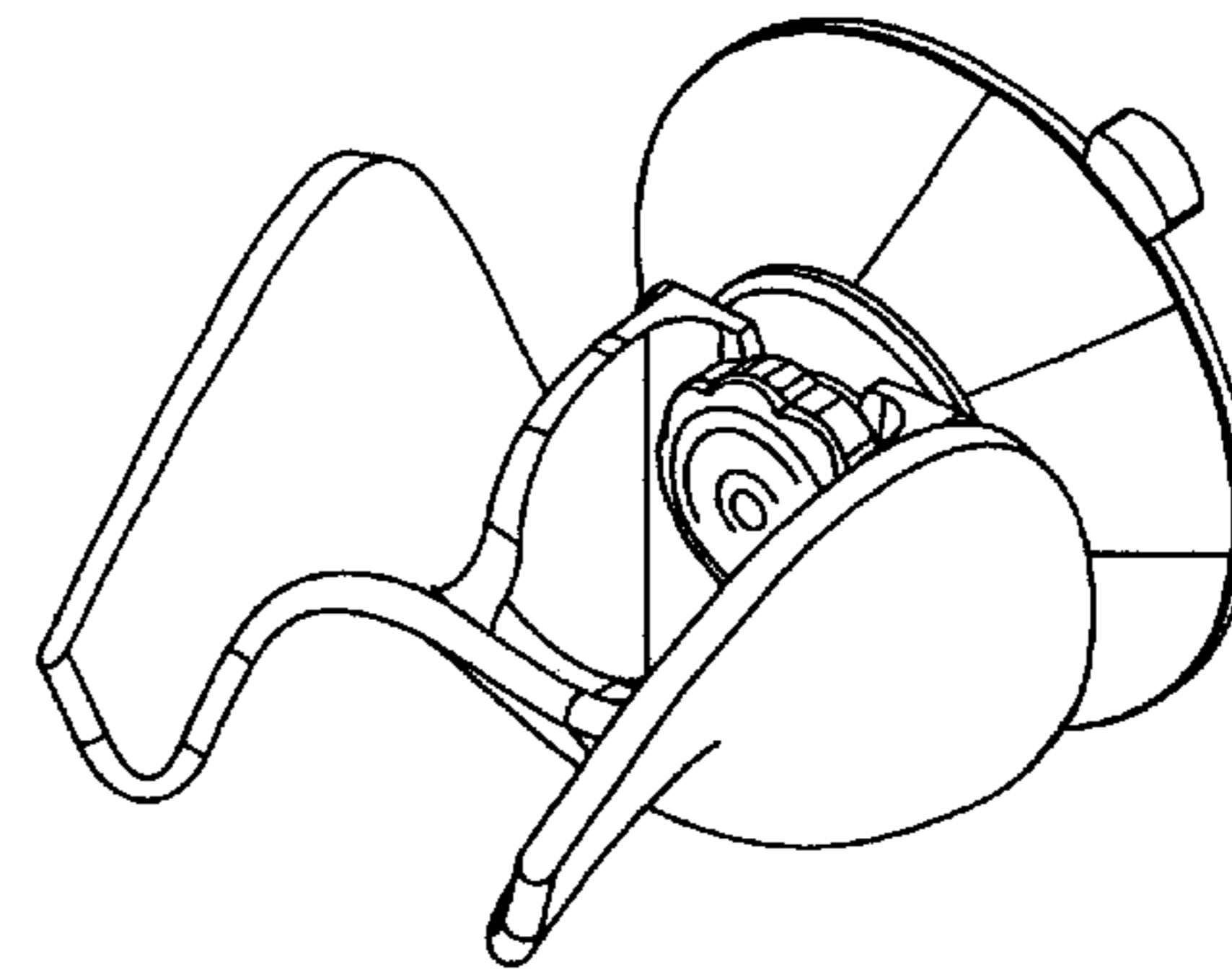

FIG. 1

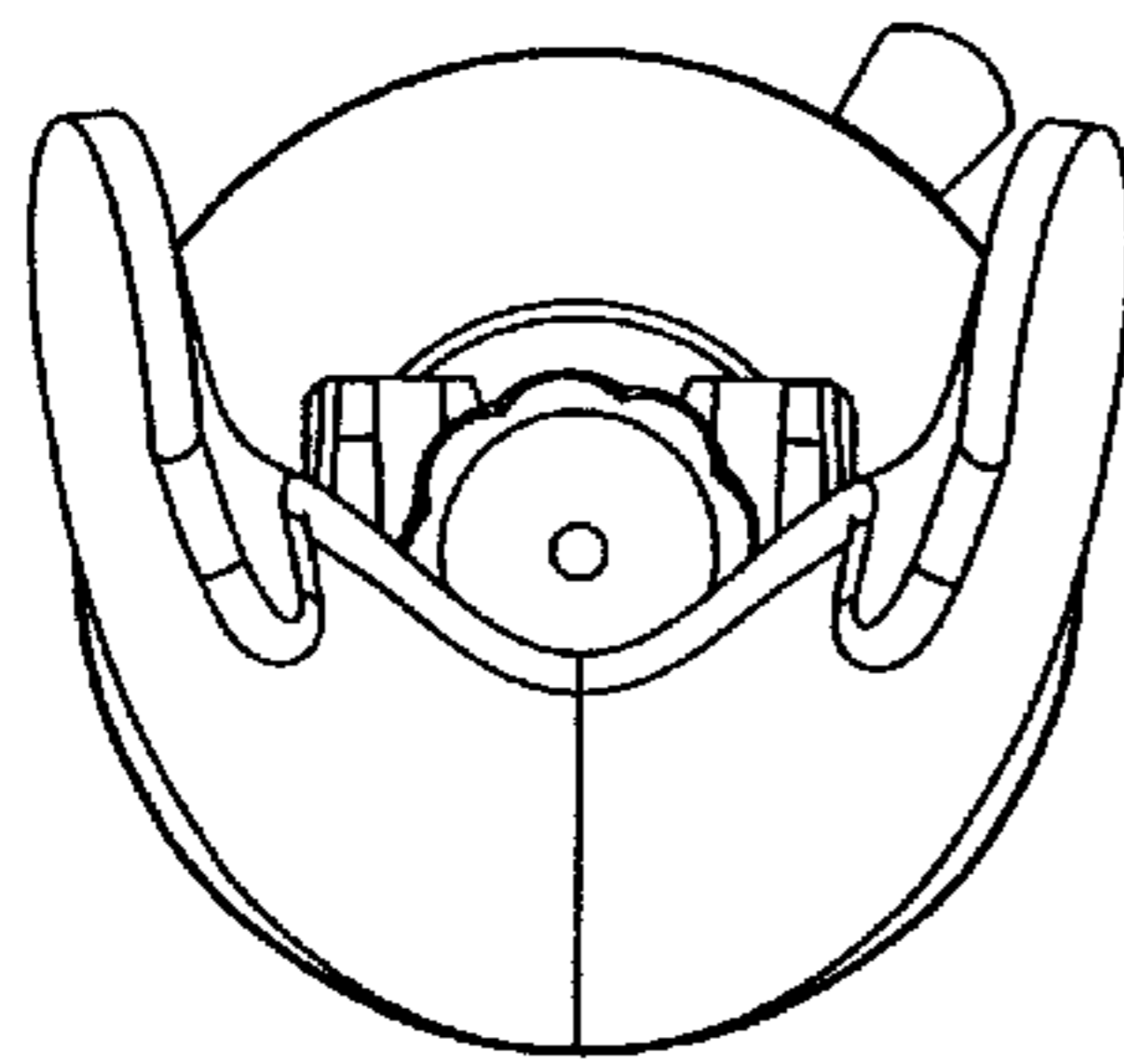

FIG. 3

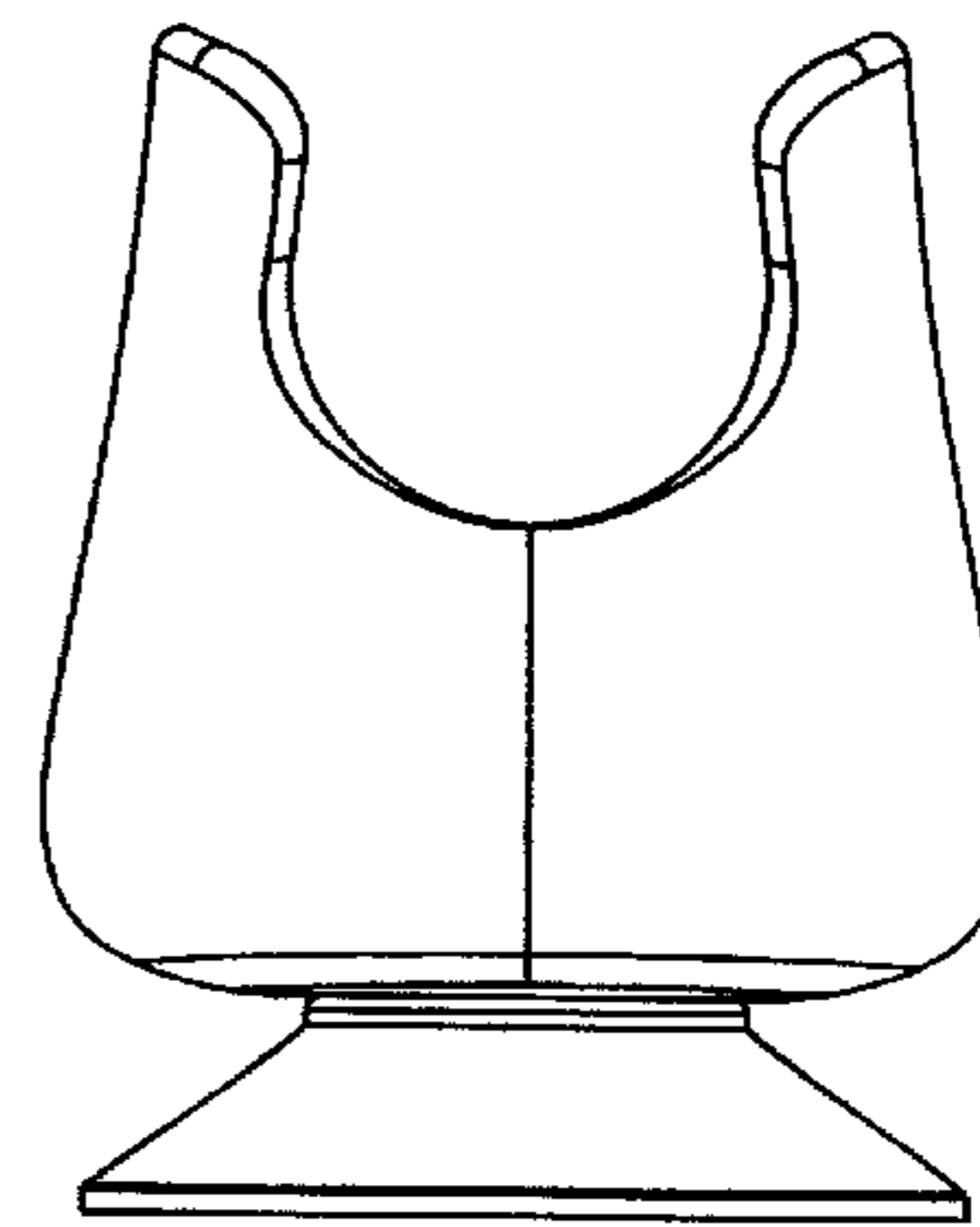

FIG. 4

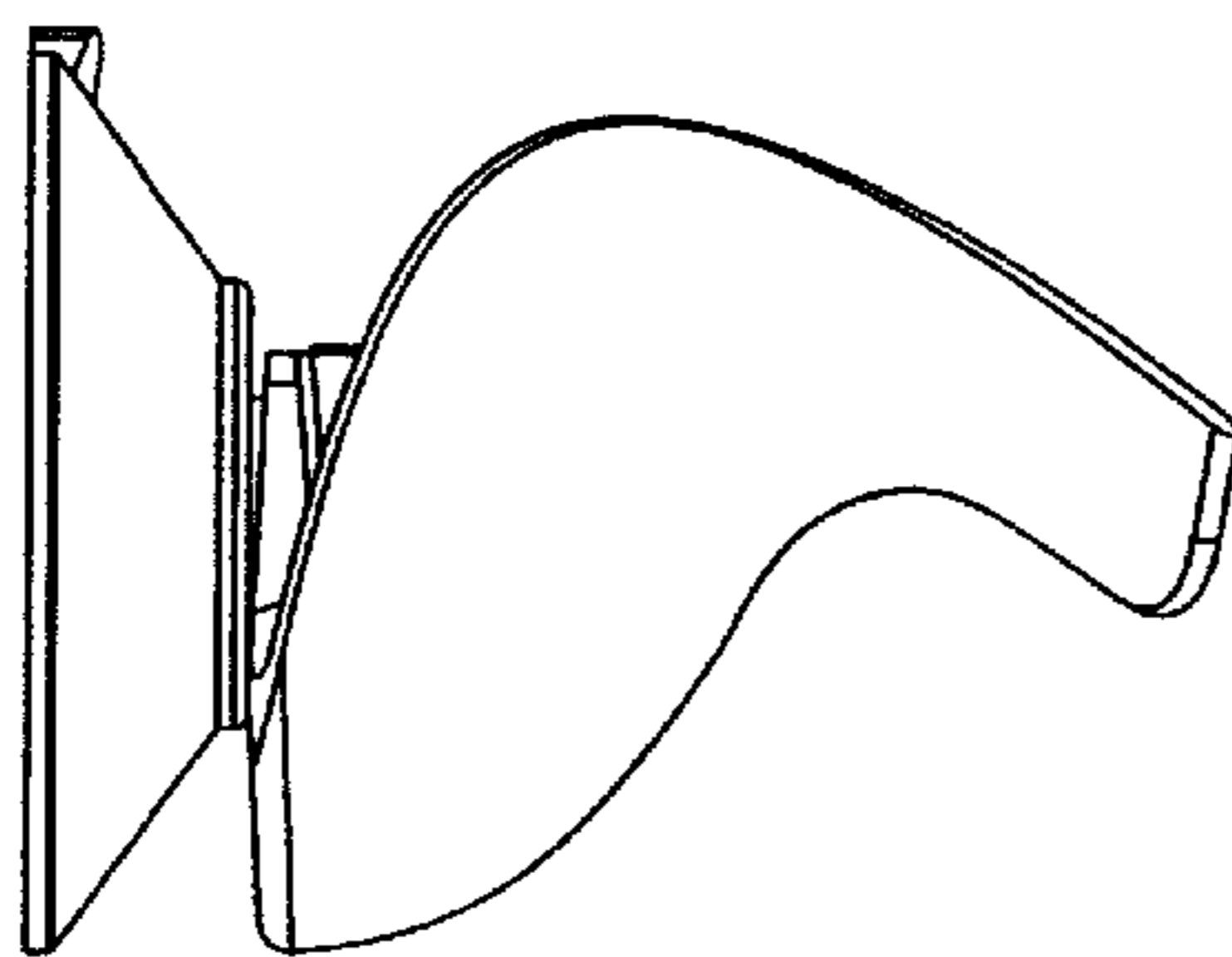

FIG. 5

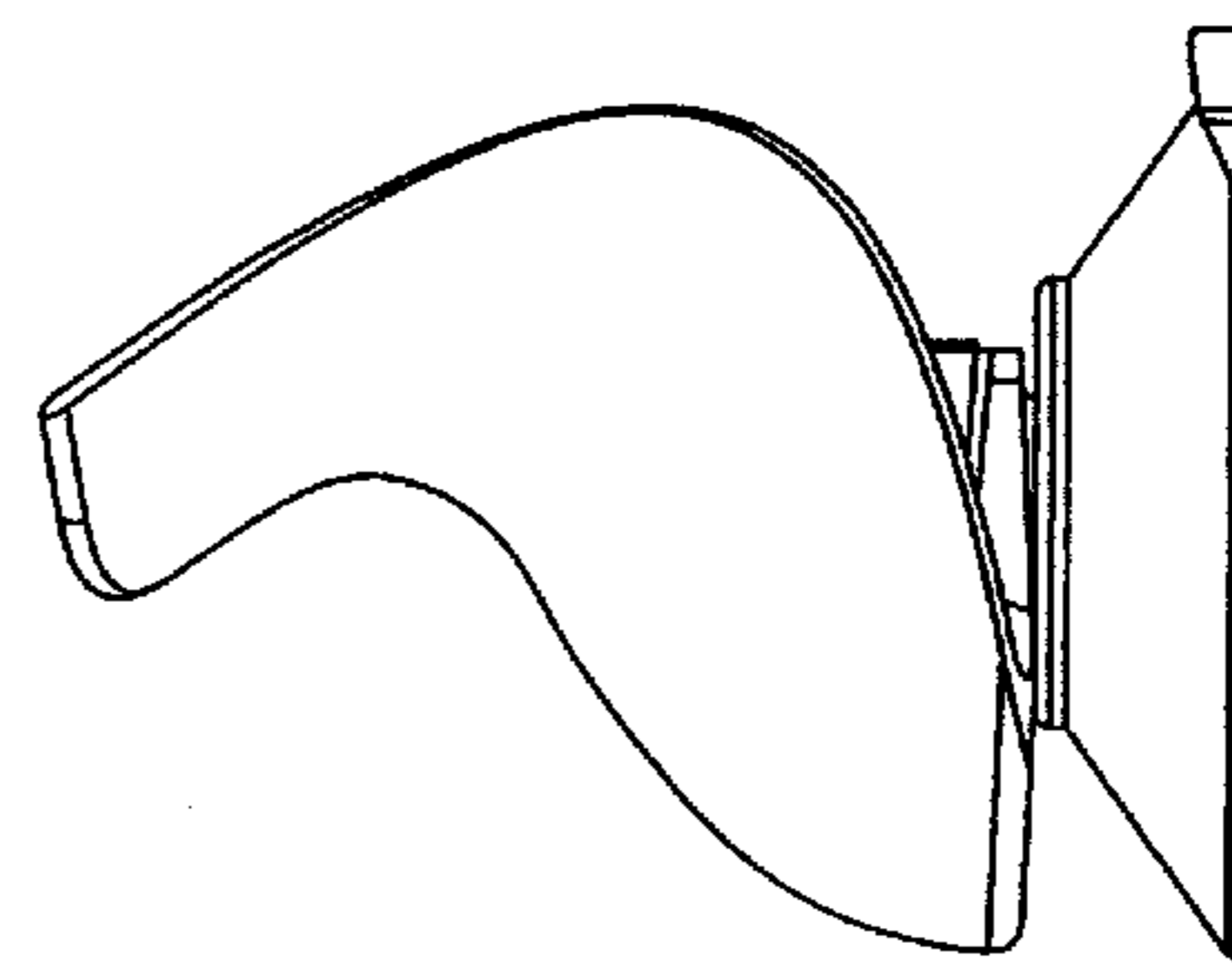

FIG. 6

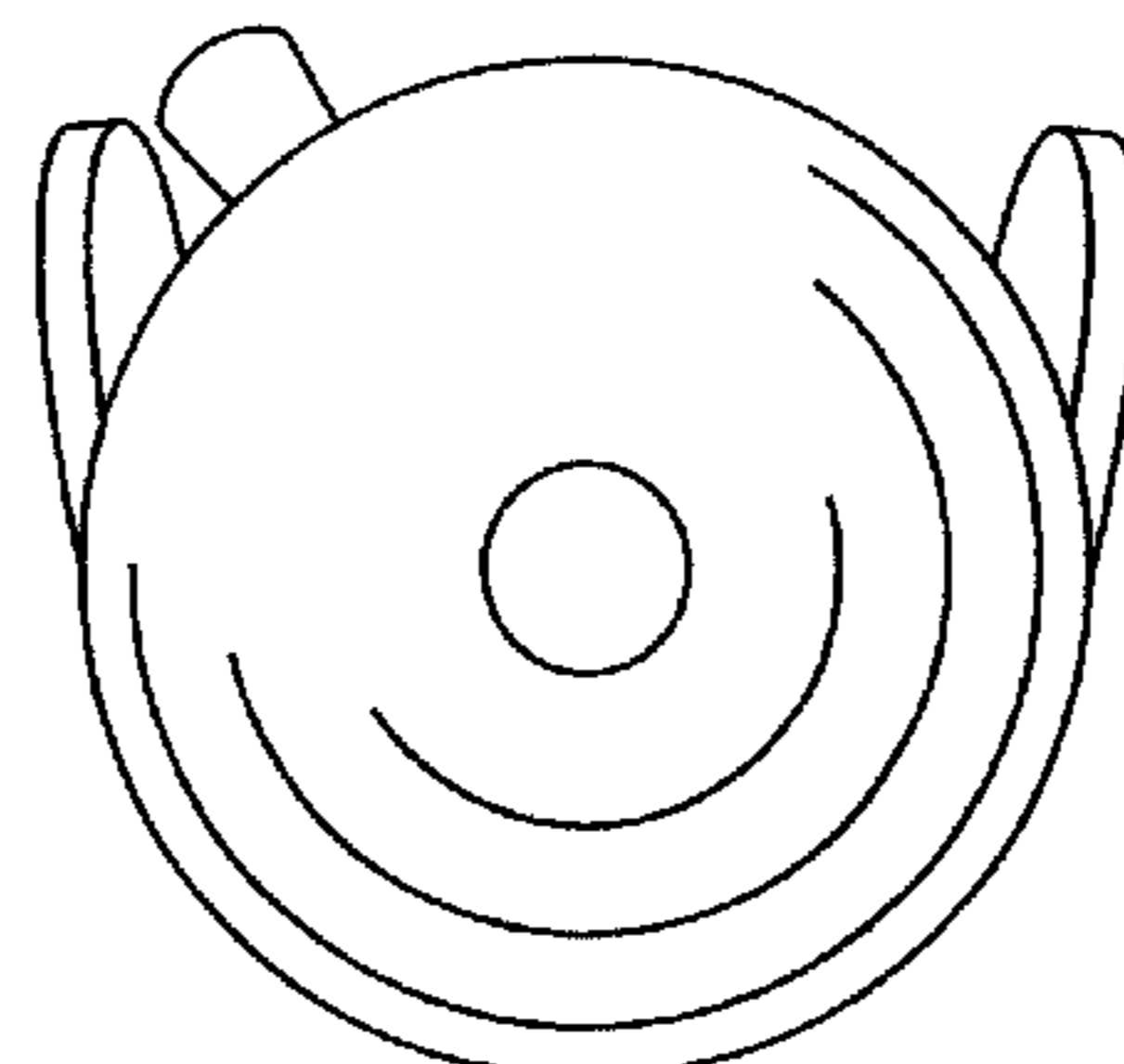

FIG. 7