



US00D533701S

(12) **United States Design Patent**  
**Payton et al.**

(10) **Patent No.:** **US D533,701 S**  
(45) **Date of Patent:** **\*\* Dec. 12, 2006**

(54) **COMBINED REFUSE RECEPTACLE AND CADDIE**

(76) Inventors: **Felton Earl Payton**, 3055 Quakertown, San Antonio, TX (US) 78230; **Martha Coleman Payton**, 3055 Quakertown, San Antonio, TX (US) 78230

(\*\*) **Term:** **14 Years**

(21) **Appl. No.:** **29/234,384**

(22) **Filed:** **Jul. 18, 2005**

(51) **LOC (8) Cl.** ..... **09-09**

(52) **U.S. Cl.** ..... **D34/5**

(58) **Field of Classification Search** ..... D34/1, D34/4, 5, 6, 7, 8, 9, 10, 11; 220/908-913, 220/675; 280/47.26, 652, 33.991, 33.998; 248/95-101; 193/2 R, 6, 4, 3, 28, 34; 232/43.1  
See application file for complete search history.

(56) **References Cited**

**U.S. PATENT DOCUMENTS**

D205,319	S	*	7/1966	Klein	.....	D34/5
3,658,233	A	*	4/1972	Voytko	.....	229/117.35
D226,628	S	*	4/1973	Shannon et al.	.....	D34/5
D231,184	S	*	4/1974	Brown et al.	.....	D34/5
4,534,576	A	*	8/1985	Jones, Jr.	.....	280/47.26
D281,284	S	*	11/1985	Reuter	.....	D34/5
4,600,113	A	*	7/1986	DeMars	.....	220/212
4,749,101	A	*	6/1988	Durkan, Jr.	.....	220/840
D345,642	S	*	3/1994	Tucker et al.	.....	D34/5
D347,095	S	*	5/1994	Apps et al.	.....	D34/5
5,397,085	A	*	3/1995	Spagnolo	.....	248/97

D358,915	S	*	5/1995	O'Donoghue	.....	D32/54
5,465,844	A	*	11/1995	Lee	.....	206/515
5,498,046	A	*	3/1996	Ridley et al.	.....	294/1.1
5,582,322	A	*	12/1996	Prout et al.	.....	220/771
5,671,933	A	*	9/1997	Tucker	.....	280/47.19
D389,971	S	*	1/1998	Zickenberg	.....	D34/5
5,776,405	A	*	7/1998	Prout et al.	.....	264/310
6,105,816	A	*	8/2000	Shea	.....	220/697
D439,718	S	*	3/2001	Thorpe	.....	D34/5
6,722,672	B1	*	4/2004	Cates et al.	.....	280/47.26
D491,328	S	*	6/2004	Aiken et al.	.....	D34/5
6,915,921	B1	*	7/2005	Mensch	.....	220/212
D509,335	S	*	9/2005	Tuduri	.....	D34/5

\* cited by examiner

*Primary Examiner*—Cynthia E. Ramirez

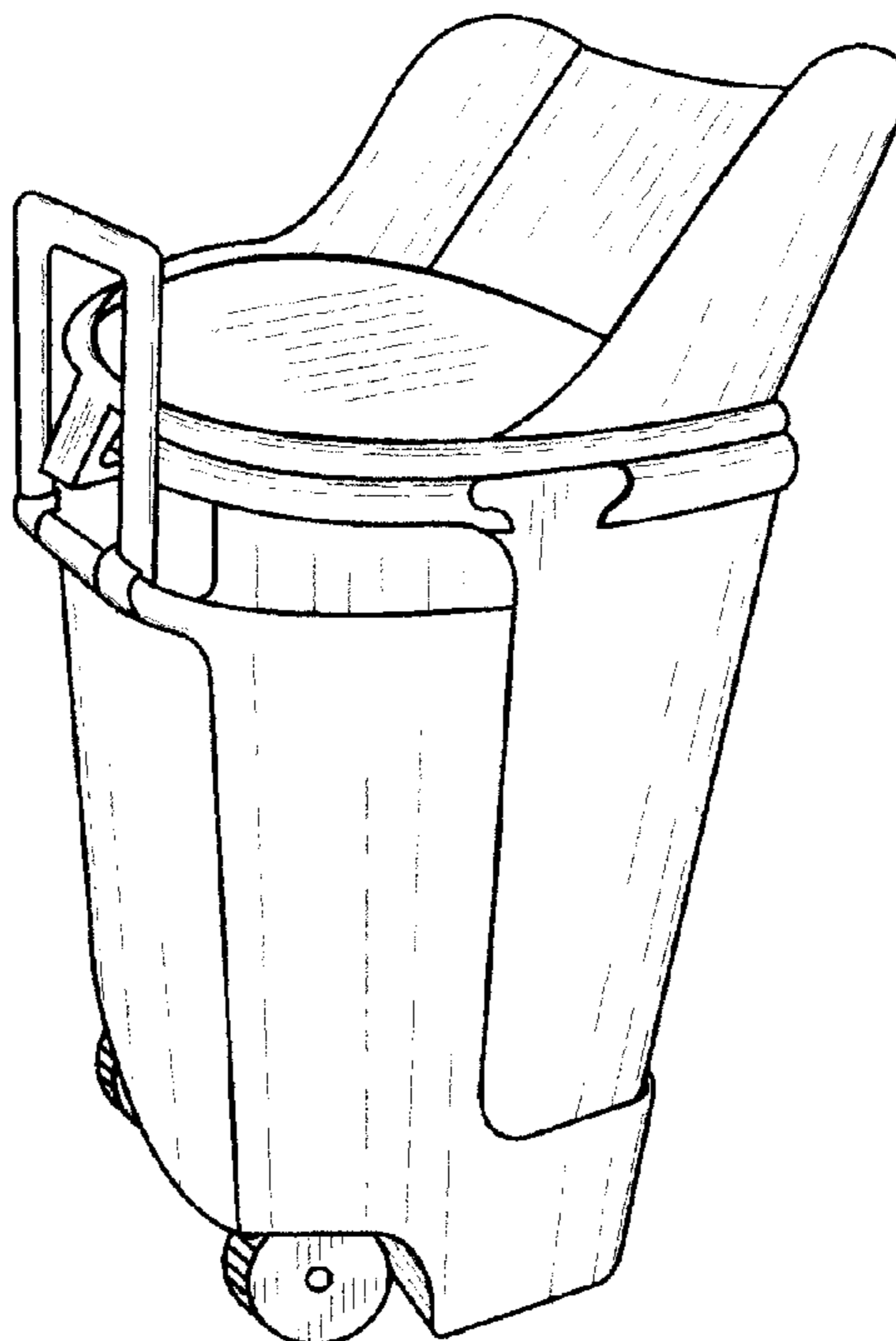
(57) **CLAIM**

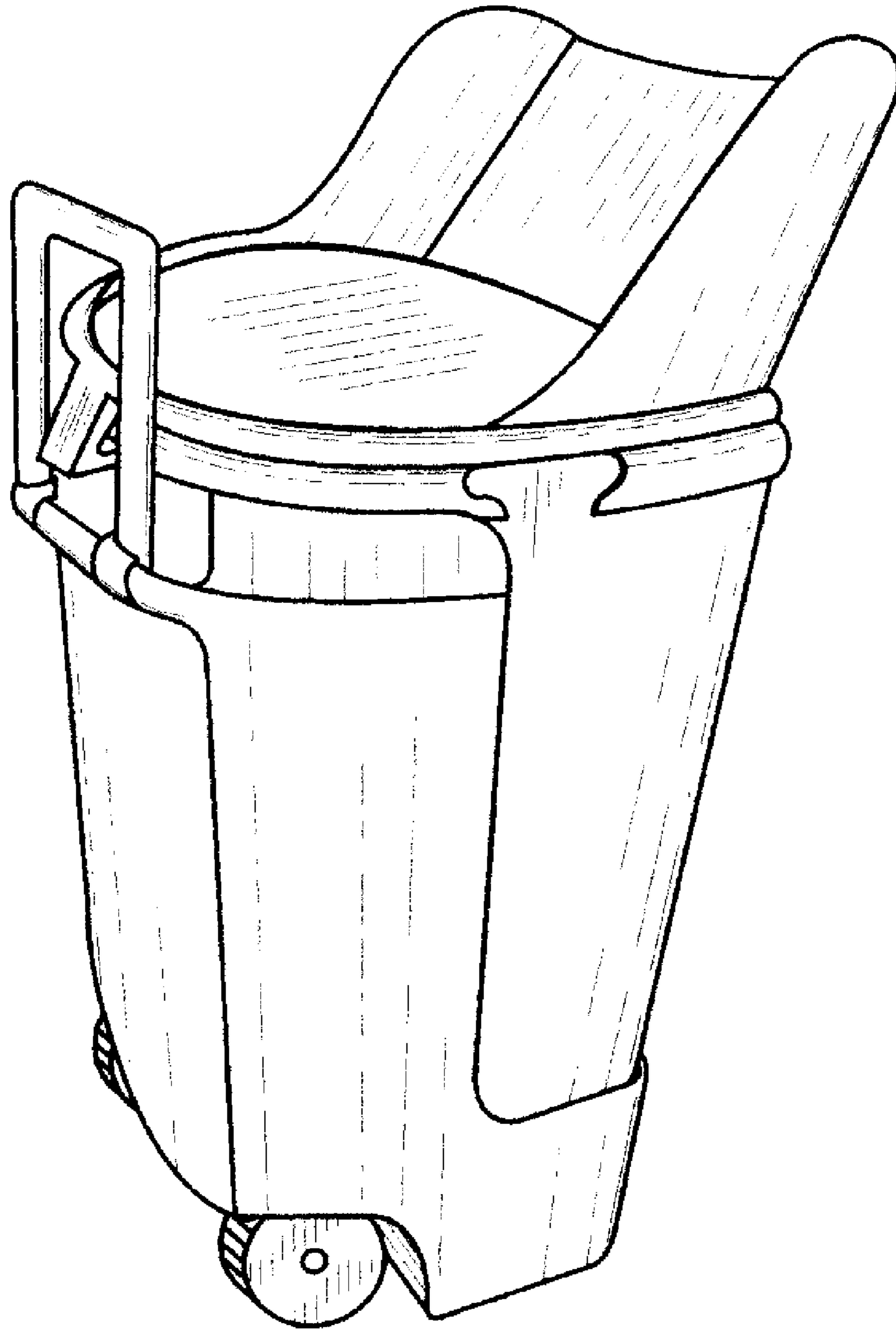
We claim the ornamental design for a combined refuse receptacle and caddie, as shown and described.

**DESCRIPTION**

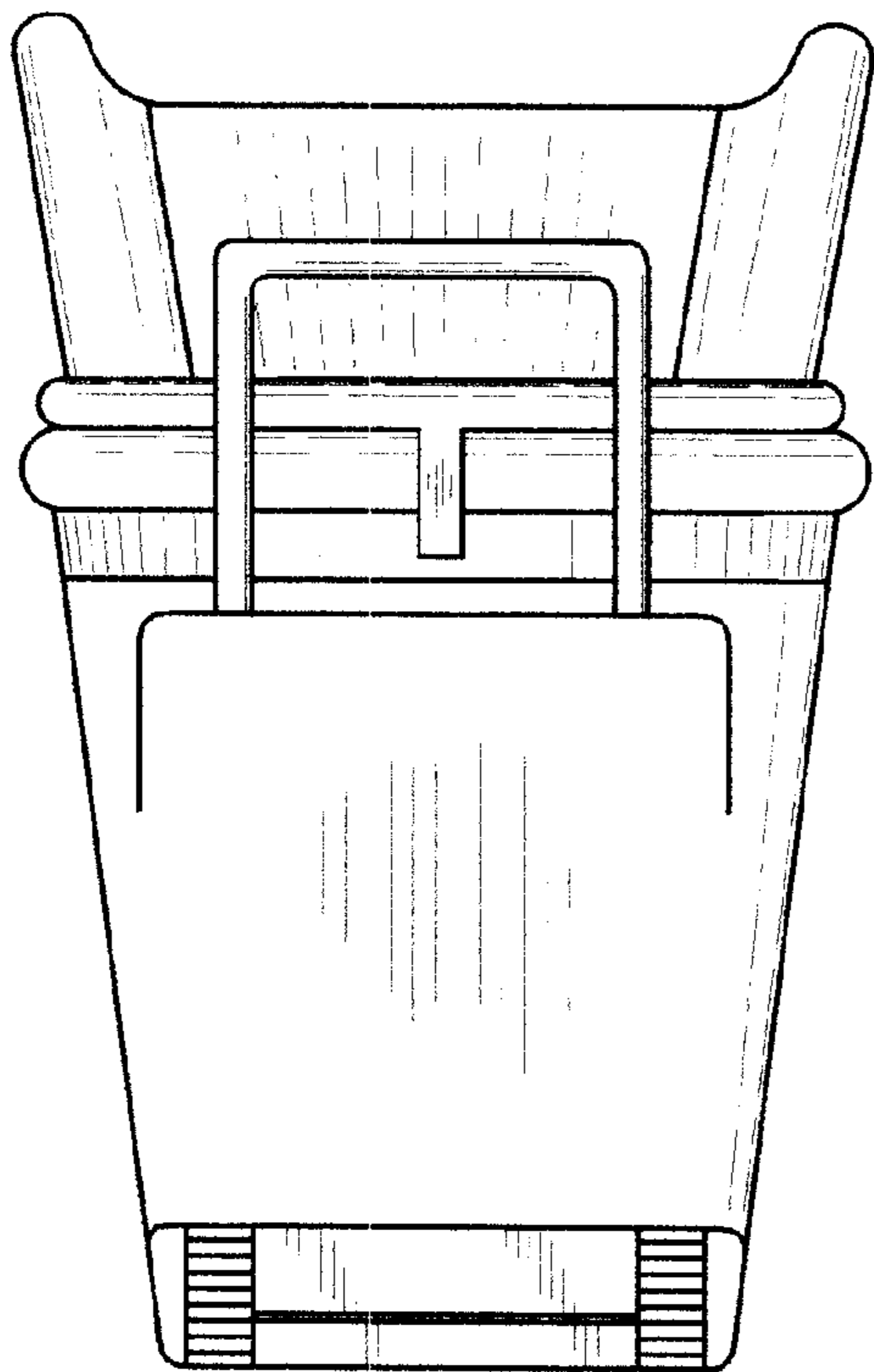
FIG. 1 is a perspective view of the combined refuse receptacle and caddie showing our new design; FIG. 2 is a rear elevational view thereof; FIG. 3 is a front elevational view thereof; FIG. 4 is a side elevational view thereof; FIG. 5 is a side elevational view of the caddie; and, FIG. 6 is a side elevational view of the refuse container. The caddie and the refuse container are shown apart in FIGS. 5 and 6 and the handle is shown broken away in FIGS. 4 and 5 for convenience of illustration.

**1 Claim, 3 Drawing Sheets**

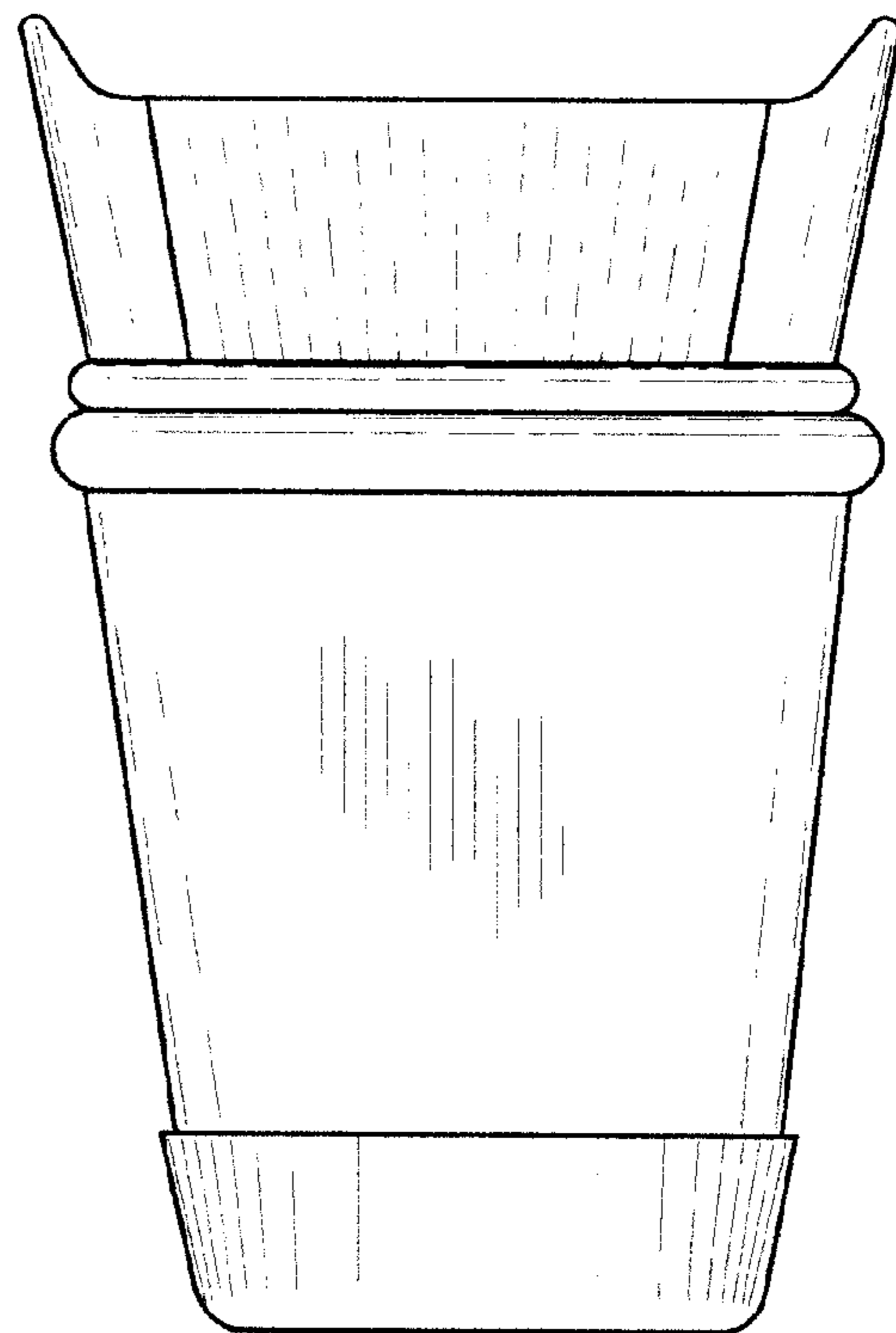




*FIG. 1*



*FIG. 2*



*FIG. 3*

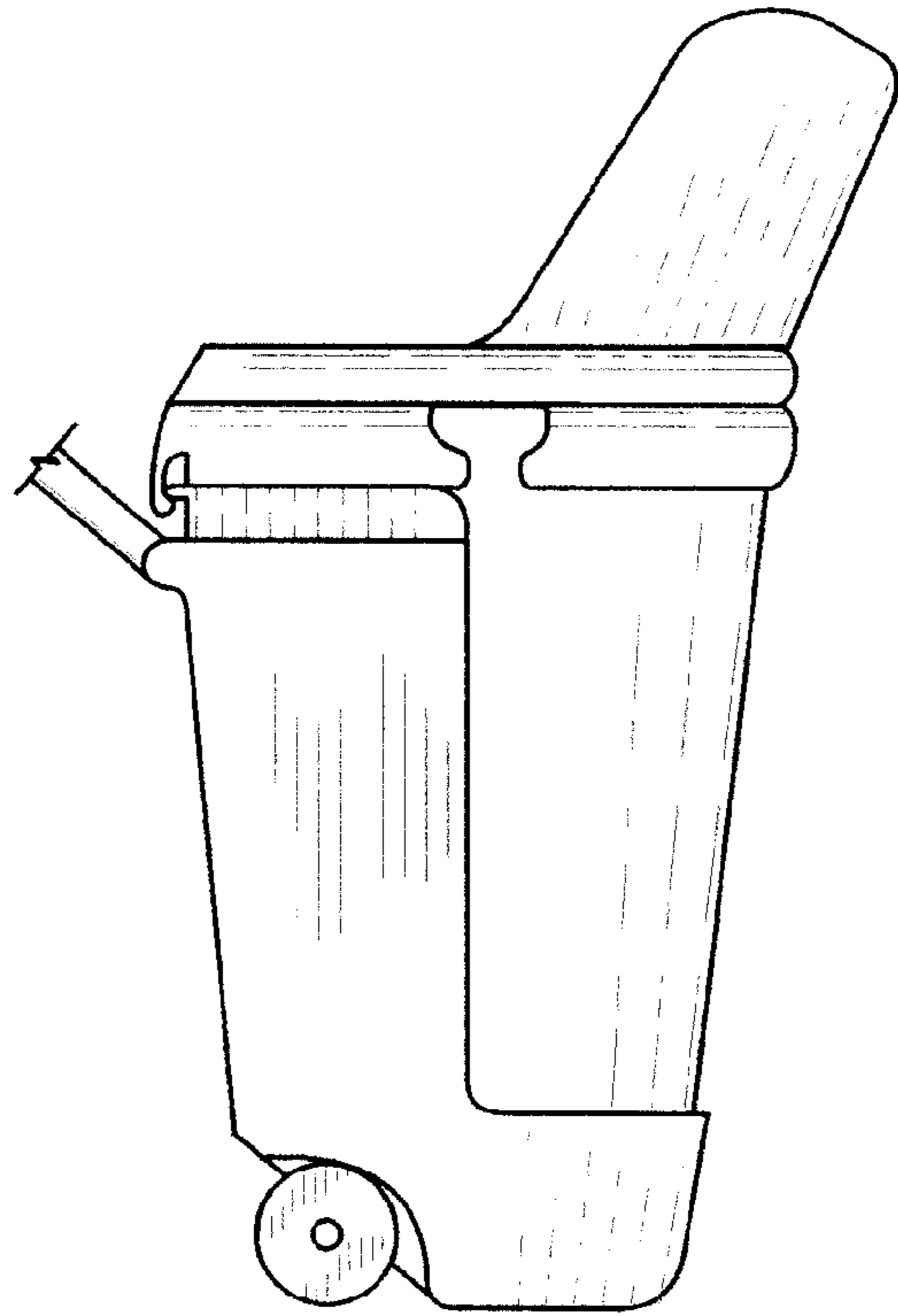


FIG. 4

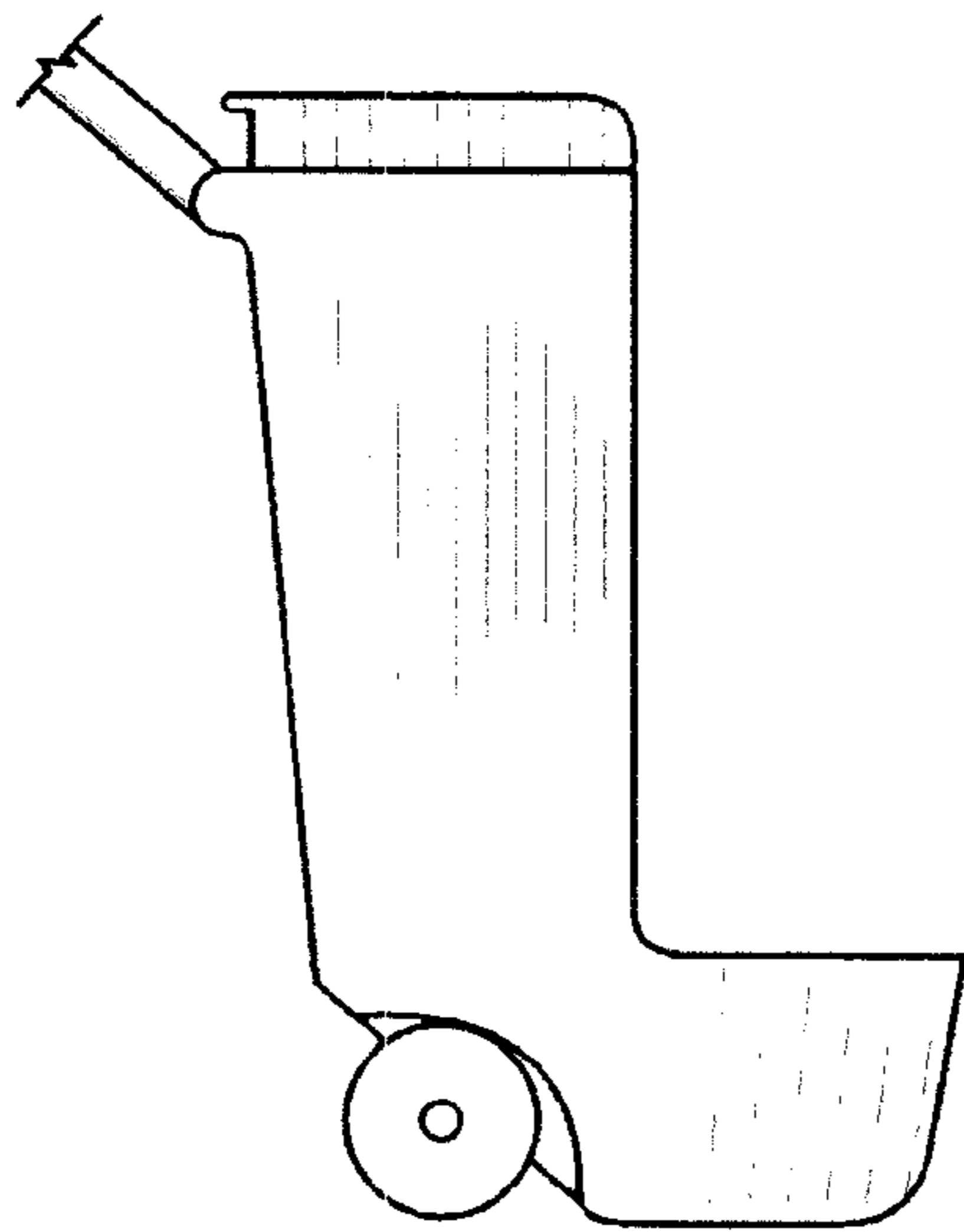


FIG. 5

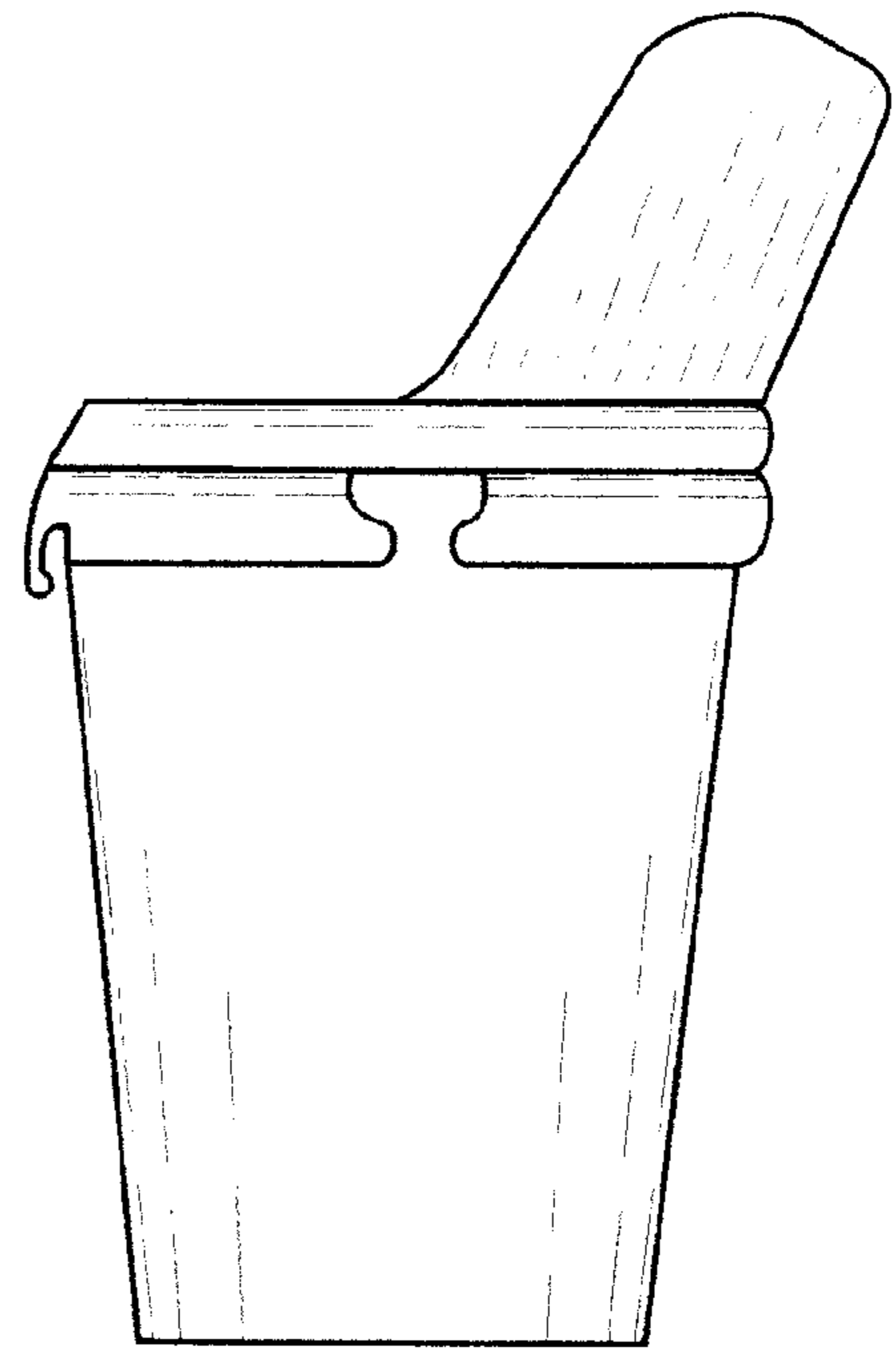


FIG. 6