



US00D533665S

(12) **United States Design Patent**
Bhavnani

(10) **Patent No.:** **US D533,665 S**

(45) **Date of Patent:** **** Dec. 12, 2006**

(54) **REFLEX HAMMER**

(75) Inventor: **Dilip Bhavnani**, Beverly Hills, CA
(US)

(73) Assignee: **Sun Coast Merchandise Corporation**,
Commerce, CA (US)

(**) Term: **14 Years**

(21) Appl. No.: **29/224,710**

(22) Filed: **Mar. 4, 2005**

(51) **LOC (8) Cl.** **24-02**

(52) **U.S. Cl.** **D24/142**

(58) **Field of Classification Search** D24/142;
D8/95, 97, 107; 600/552, 553, 557
See application file for complete search history.

(56) **References Cited**

U.S. PATENT DOCUMENTS

D400,421 S	*	11/1998	Okada	D8/97
D427,679 S	*	7/2000	Coe	D24/142
D468,614 S	*	1/2003	Kanzawa	D8/97
D510,008 S	*	9/2005	Kanzawa	D8/97
D517,211 S	*	3/2006	Nuttall et al.	D24/142

* cited by examiner

Primary Examiner—Antoine D. Davis

Assistant Examiner—Christopher Lee

(74) *Attorney, Agent, or Firm*—The Soni Law Firm

(57) **CLAIM**

The ornamental design for a reflex hammer, as shown and described.

DESCRIPTION

FIG. 1 is a front perspective view of a reflex hammer;
 FIG. 2 is a front elevation view of the reflex hammer of FIG. 1;
 FIG. 3 is a left side view of the reflex hammer of FIG. 1;
 FIG. 4 is a right side view of the reflex hammer of FIG. 1;
 FIG. 5 is a bottom plan view of the reflex hammer of FIG. 1;
 FIG. 6 is a top plan view of the reflex hammer of FIG. 1; and
 FIG. 7 is a top front perspective view of an alternate position of the reflex hammer of FIG. 1;
 FIG. 8 is a front elevation view of an alternate position of the reflex hammer of FIG. 1;
 FIG. 9 is a left side view of an alternate position of the reflex hammer of FIG. 1;
 FIG. 10 is a right side view of an alternate position of the reflex hammer of FIG. 1;
 FIG. 11 is a bottom plan view of an alternate position of the reflex hammer of FIG. 1; and,
 FIG. 12 is a top plan view of an alternate position of the reflex hammer of FIG. 1.

1 Claim, 4 Drawing Sheets

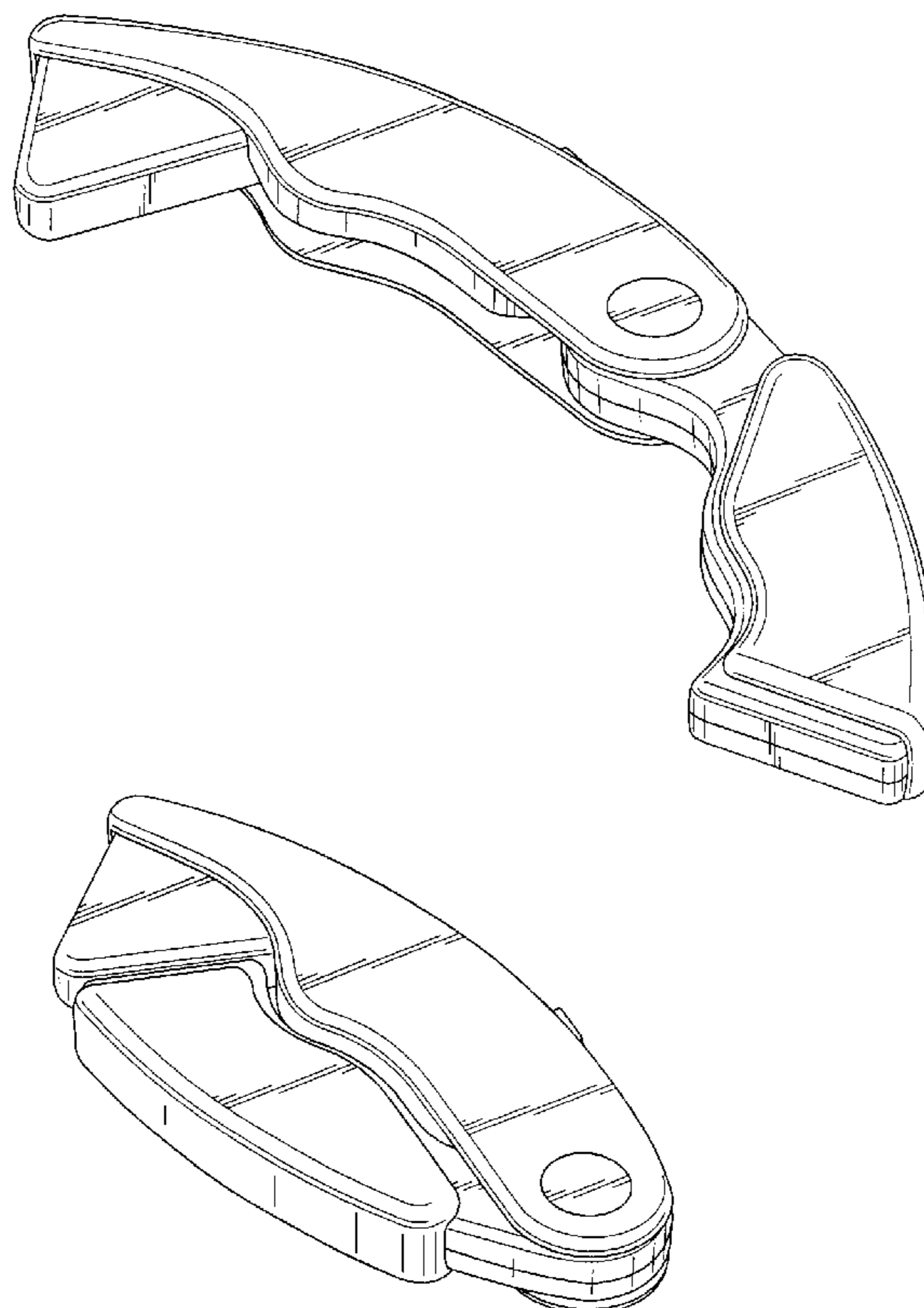

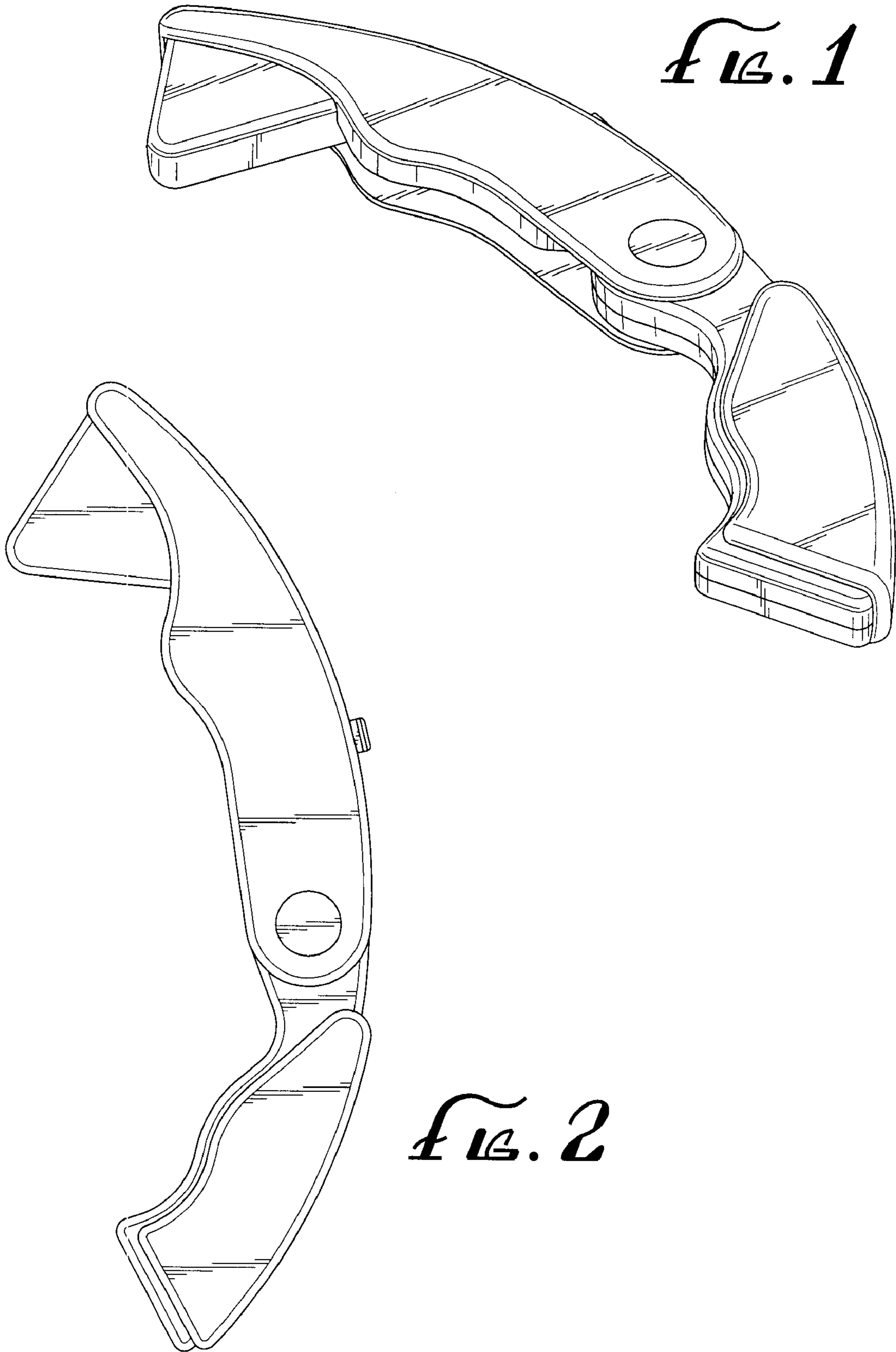

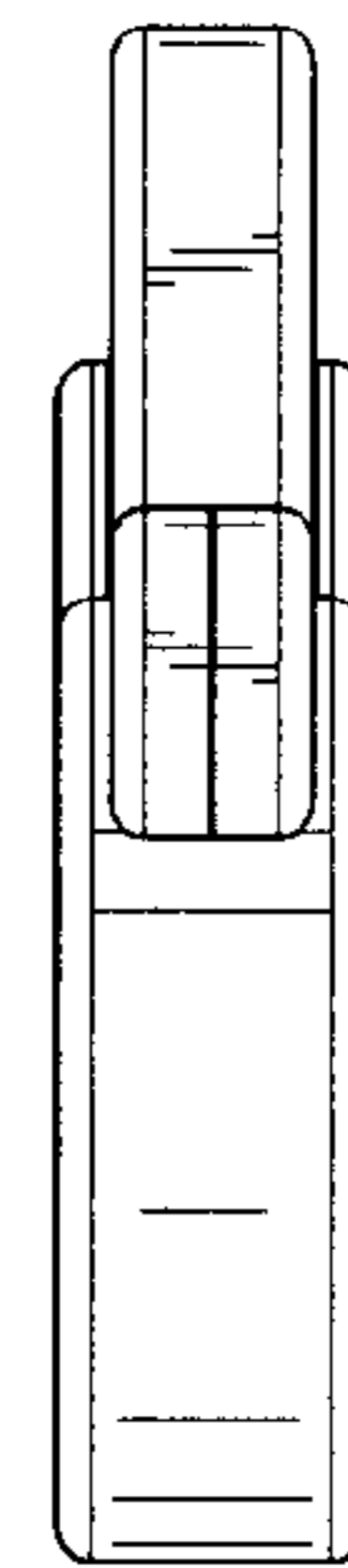
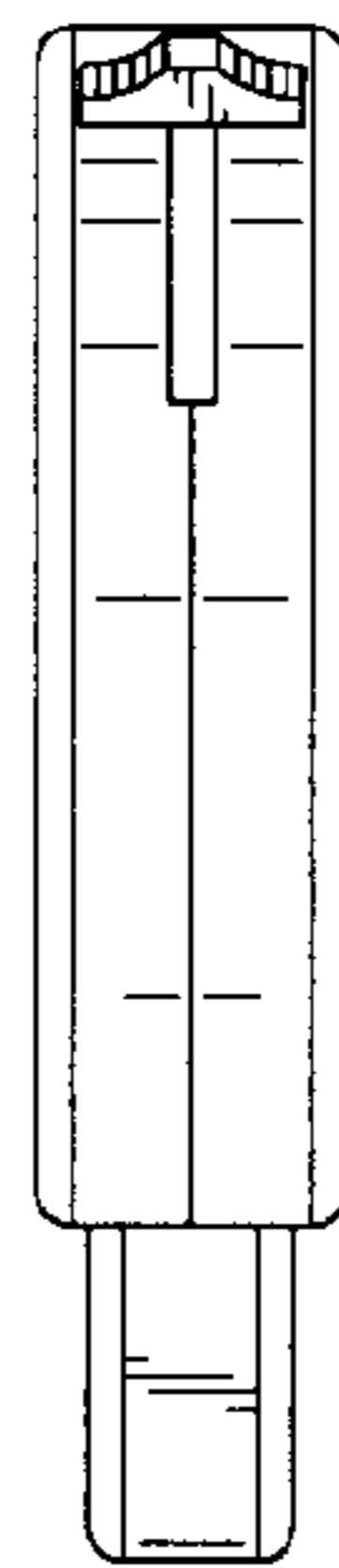
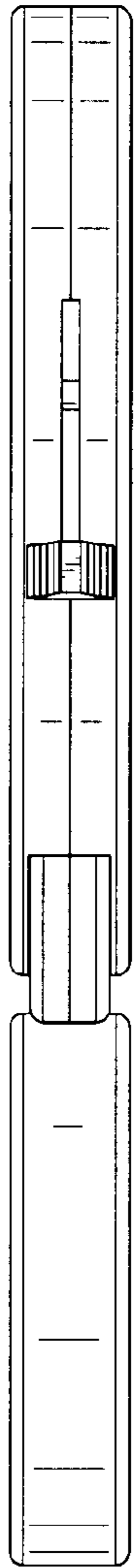
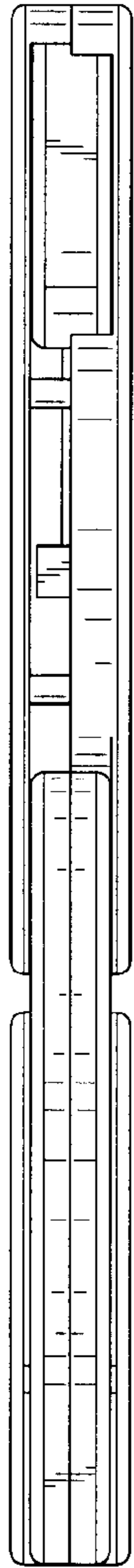

FIG. 3

FIG. 4

FIG. 5

FIG. 6

FIG. 7

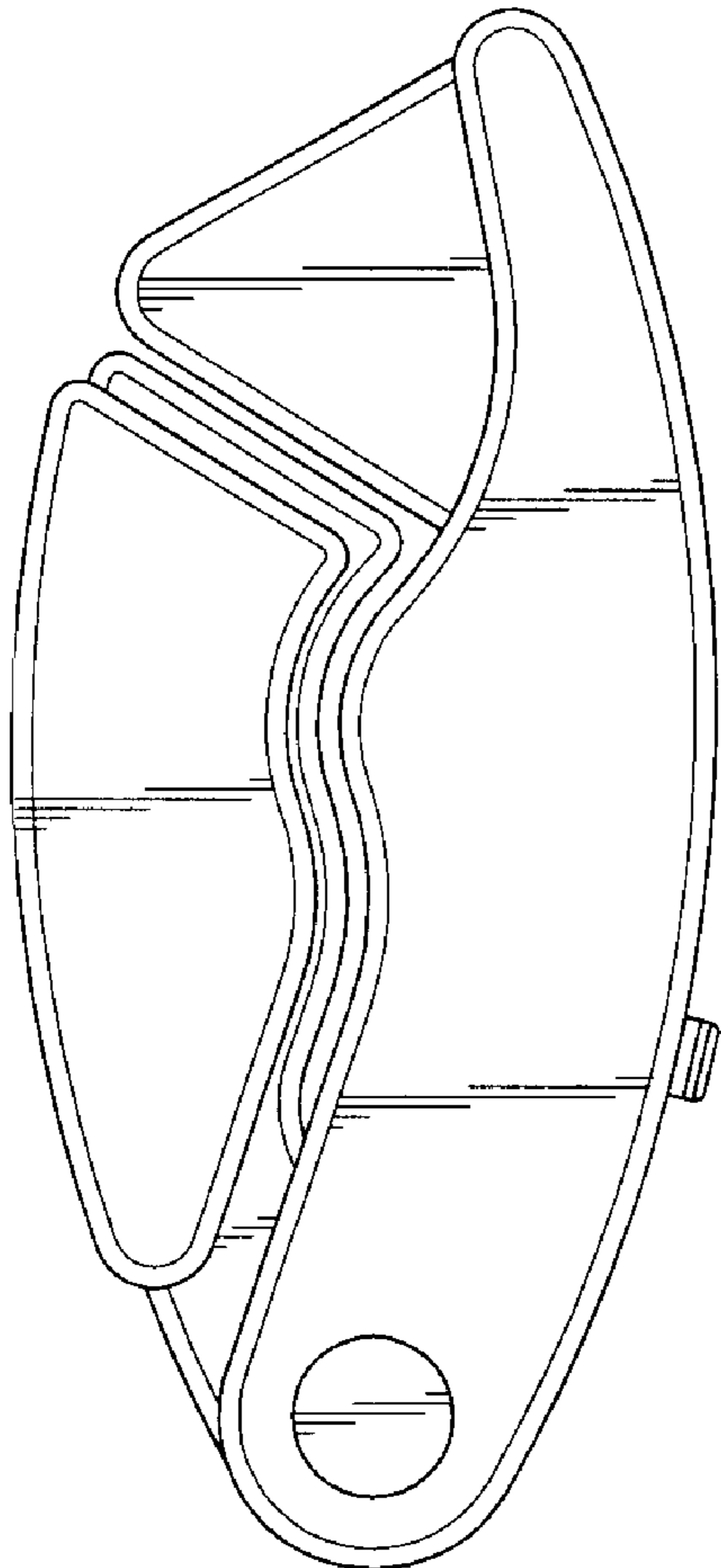
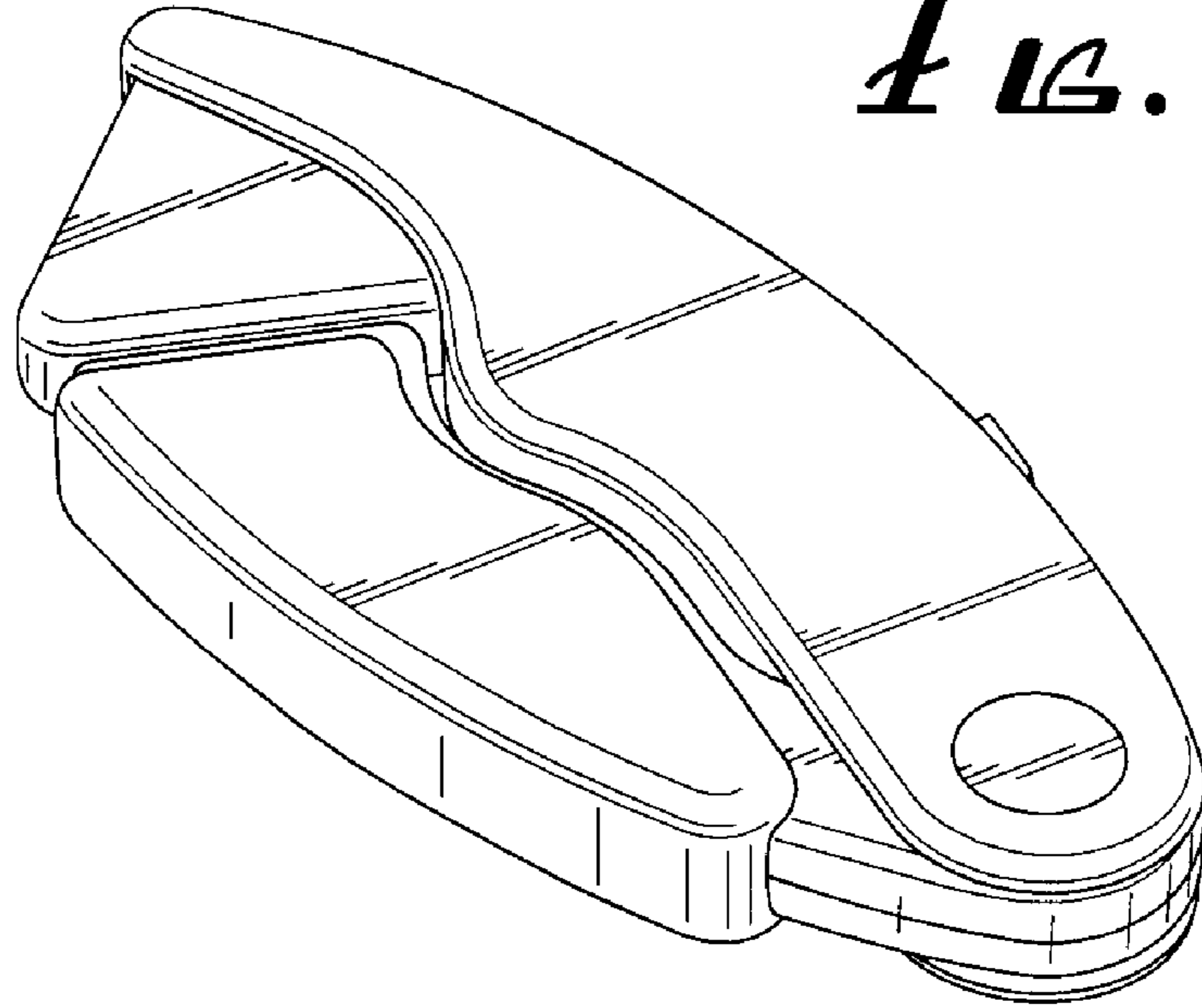

FIG. 8

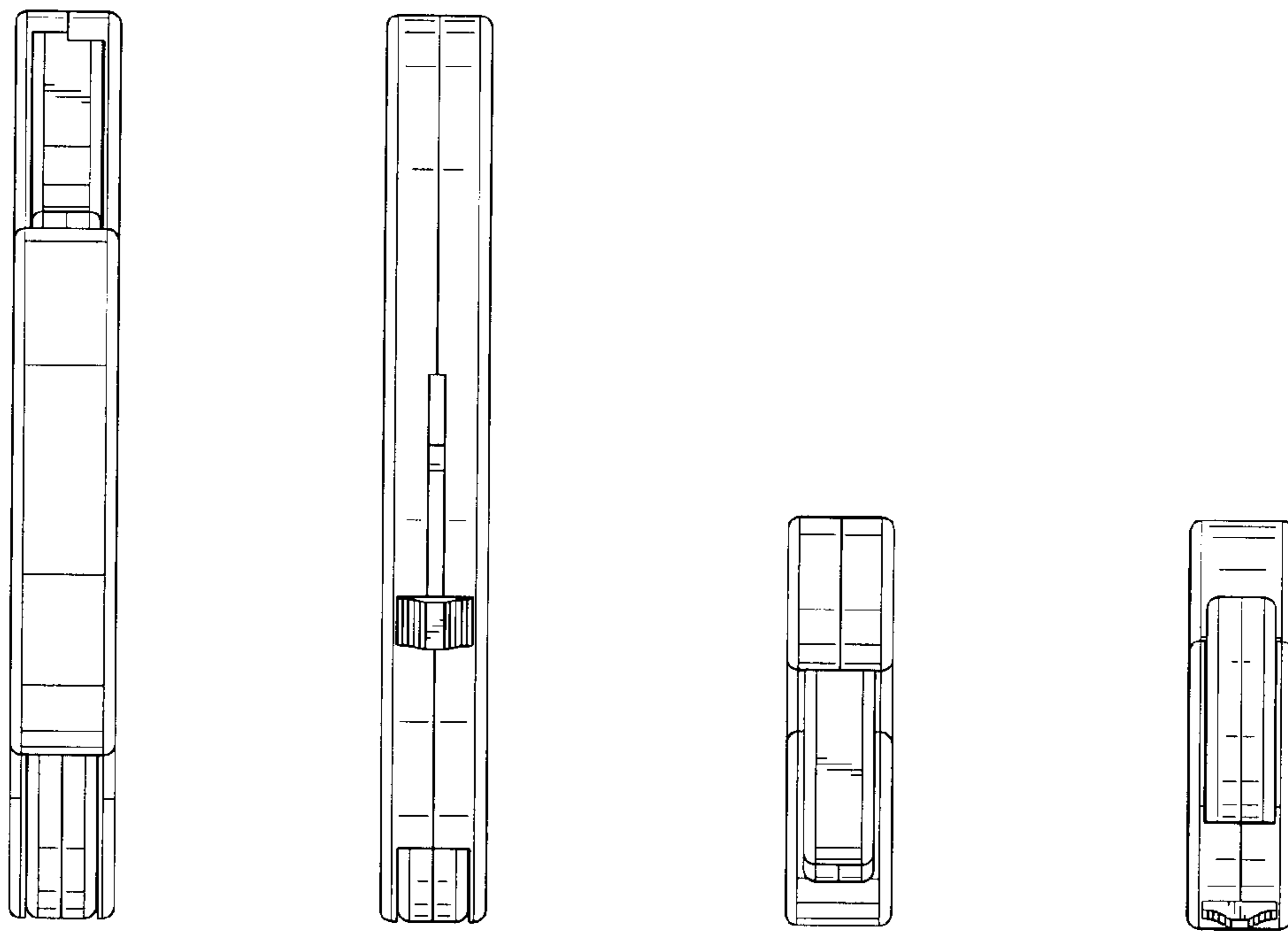

FIG. 9 *FIG. 10* *FIG. 11* *FIG. 12*