



US00D533608S

(12) **United States Design Patent**
Bingham, Jr. et al.

(10) **Patent No.: US D533,608 S**
(45) **Date of Patent: ** Dec. 12, 2006**

(54) **SEAT FOR EXERCISE MACHINES**

D482,218 S * 11/2003 Lin D6/500
D513,421 S * 1/2006 Nagano D21/666

(75) Inventors: **Robert J. Bingham, Jr.**, Everett, WA
(US); **Mark A. Zeh**, Munich (DE)

OTHER PUBLICATIONS

Printouts from the Exercise Bike Superstore websight. dated back to Jan. 2004.*

(73) Assignee: **LeMond Fitness, Inc.**, Woodinville, WA (US)

* cited by examiner

(**) Term: **14 Years**

Primary Examiner—Philip S. Hyder

(21) Appl. No.: **29/223,866**

(74) *Attorney, Agent, or Firm*—George C. Rondeau, Jr.; Davis Wright Tremaine LLP

(22) Filed: **Feb. 17, 2005**

(57) **CLAIM**

(51) **LOC (8) Cl.** **21-02**

The ornamental design for a seat for exercise machines, as shown and described.

(52) **U.S. Cl.** **D21/695; D6/501**

(58) **Field of Classification Search** D21/663,
D21/664, 665, 667, 666, 690, 694, 695; 482/53,
482/54, 57, 58, 142; D6/500, 501, 502
See application file for complete search history.

DESCRIPTION

(56) **References Cited**

U.S. PATENT DOCUMENTS

- D320,826 S * 10/1991 Hildebrandt et al. D21/666
- D321,225 S * 10/1991 Solow et al. D21/695
- D340,961 S * 11/1993 Miller D21/695
- D353,422 S * 12/1994 Bostic et al. D21/665
- D386,023 S * 11/1997 Stumpf et al. D6/500
- D403,032 S * 12/1998 Huang D21/666
- D437,039 S * 1/2001 Yamazaki et al. D23/364
- D437,369 S * 2/2001 Tsushi D21/666
- D461,210 S * 8/2002 Fon D21/666

FIG. 1 is a front perspective view of a seat for exercise machines showing our new design.
 FIG. 2 is a rear perspective view thereof.
 FIG. 3 is a front elevational view thereof.
 FIG. 4 is a rear elevational view thereof.
 FIG. 5 is a left side elevational view thereof, the right side elevational view being a mirror image thereof.
 FIG. 6 is a top plan view thereof; and,
 FIG. 7 is a bottom plan view thereof.

The broken lines are for illustrative purposes only and form no part of the claimed design.

1 Claim, 7 Drawing Sheets

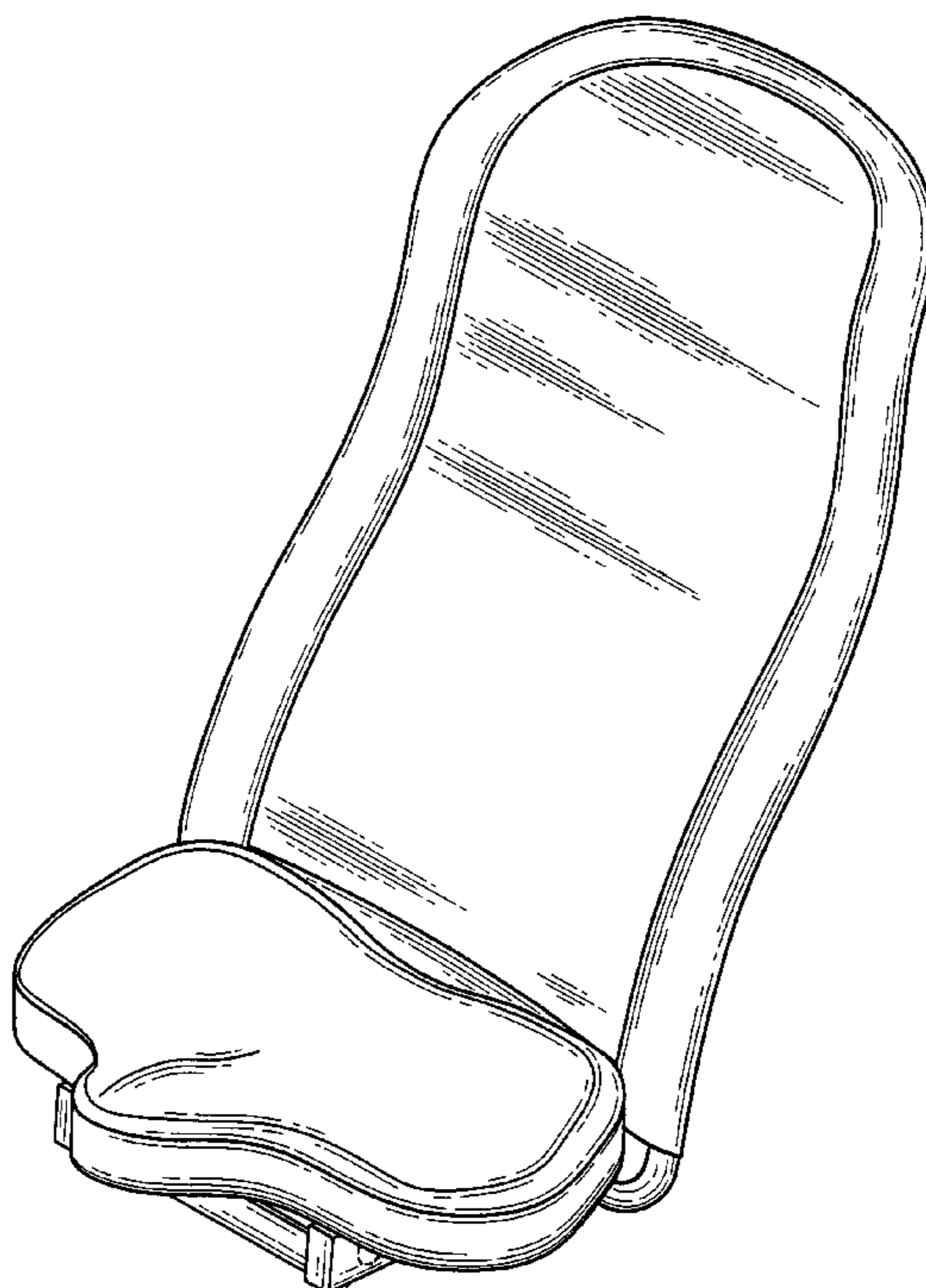

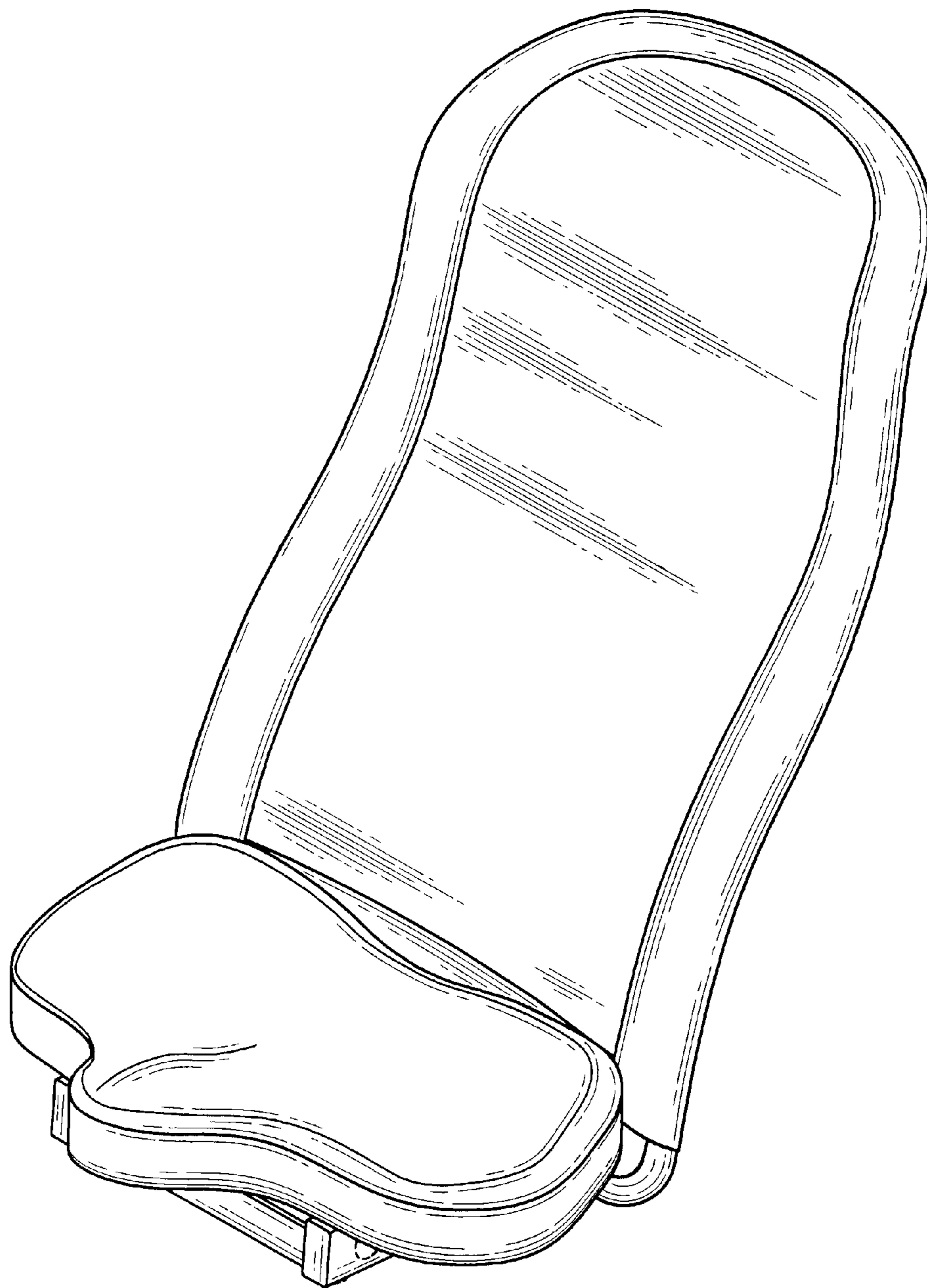

Fig. 1

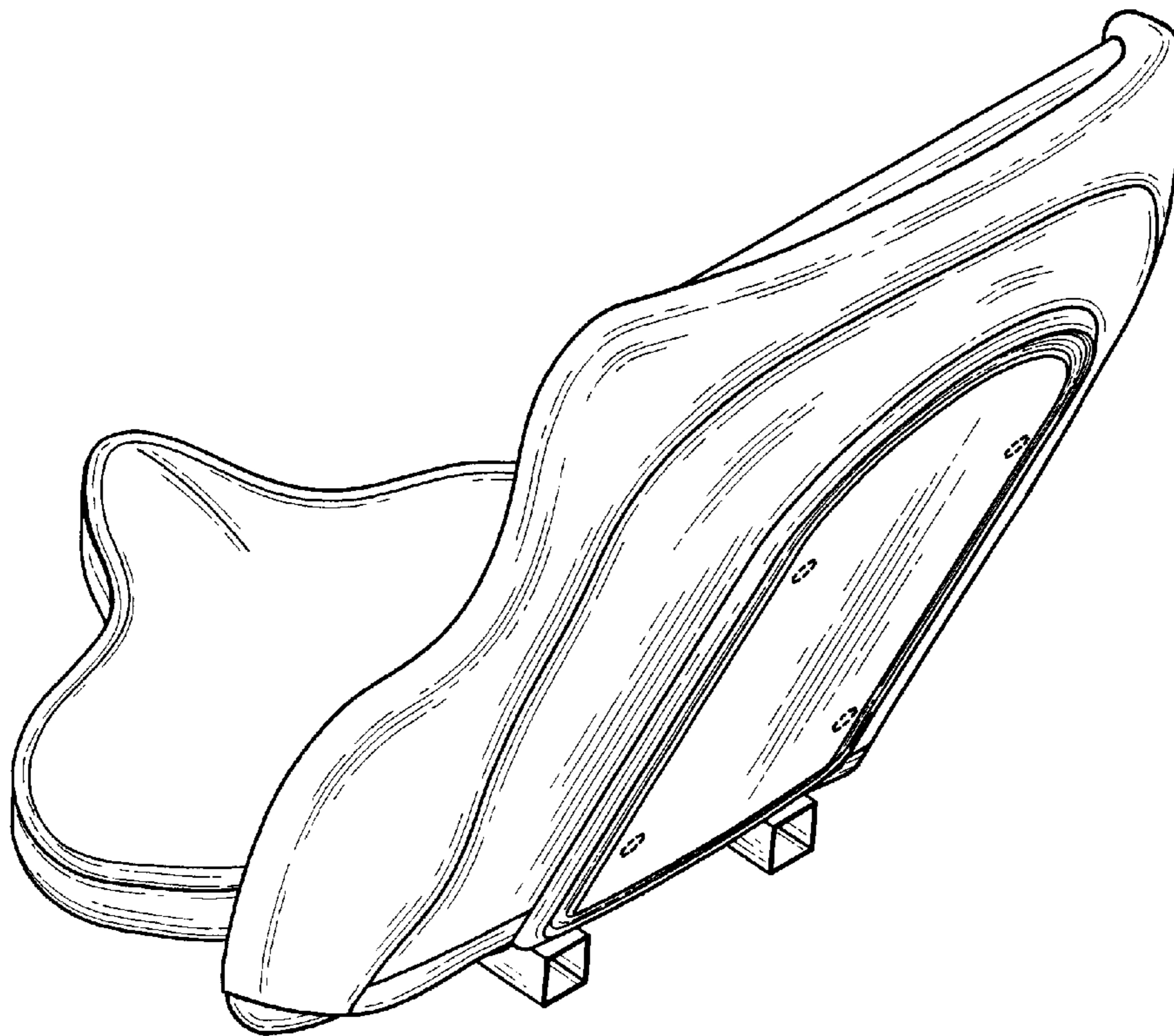

Fig. 2

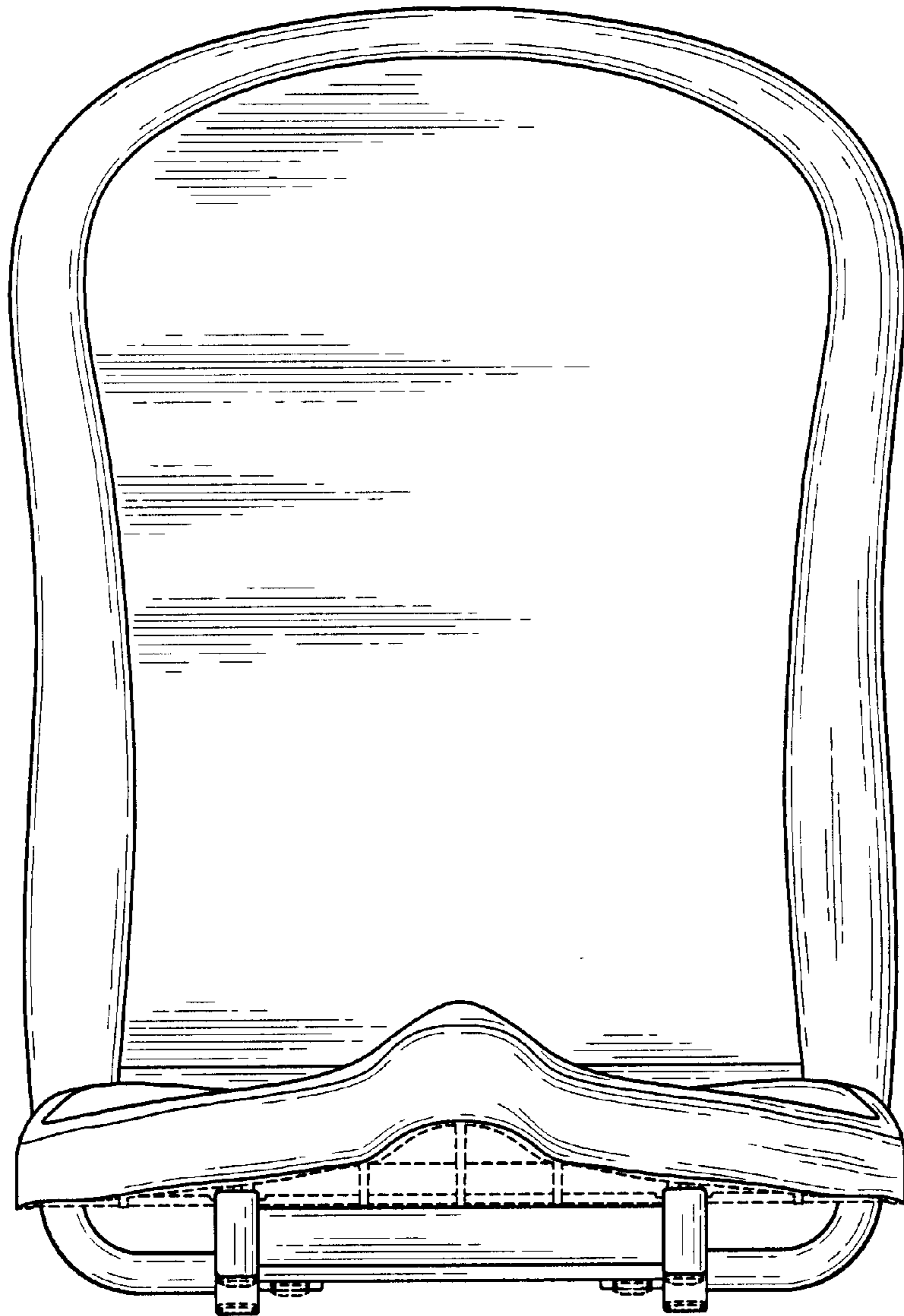

Fig. 3

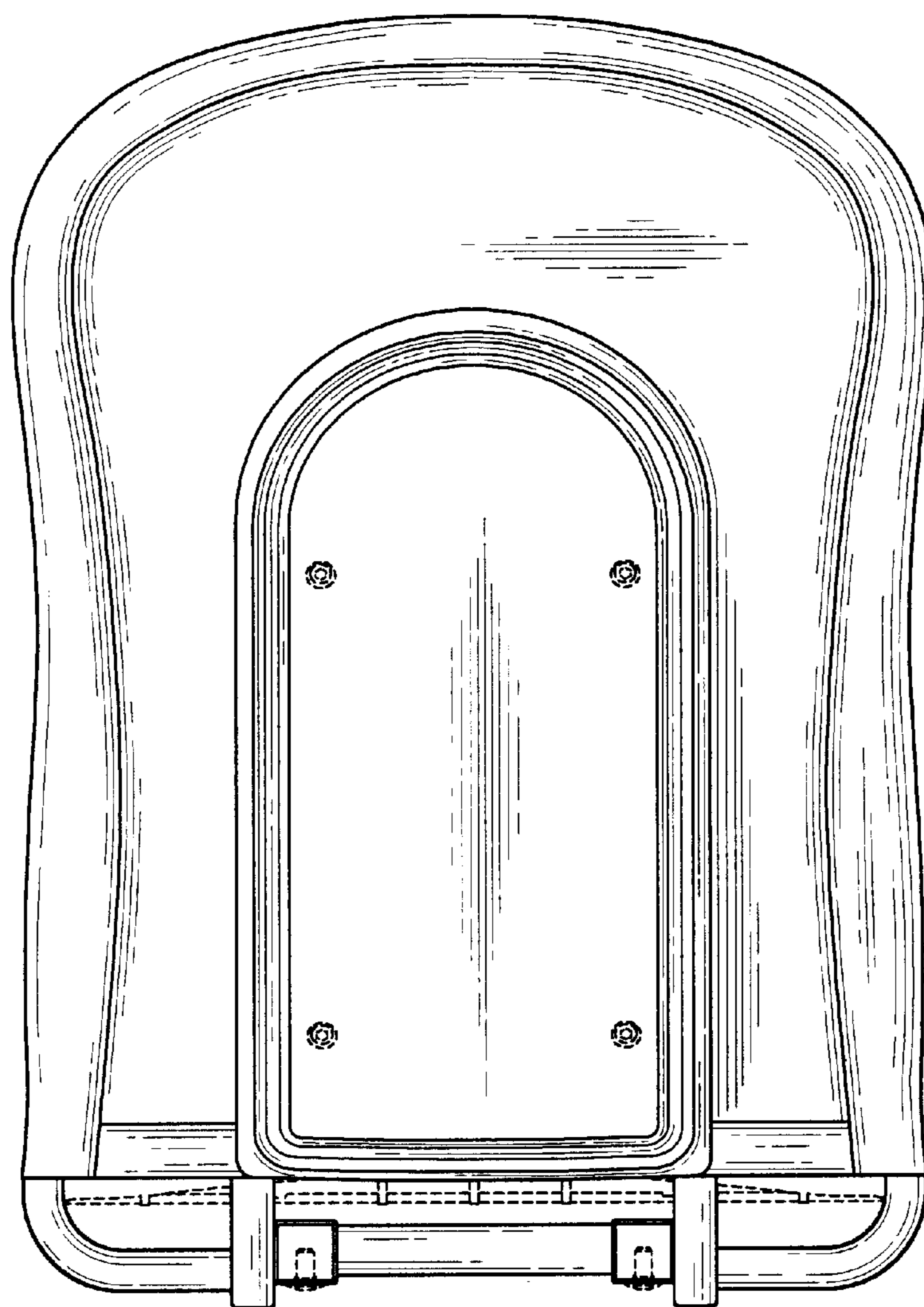

Fig. 4

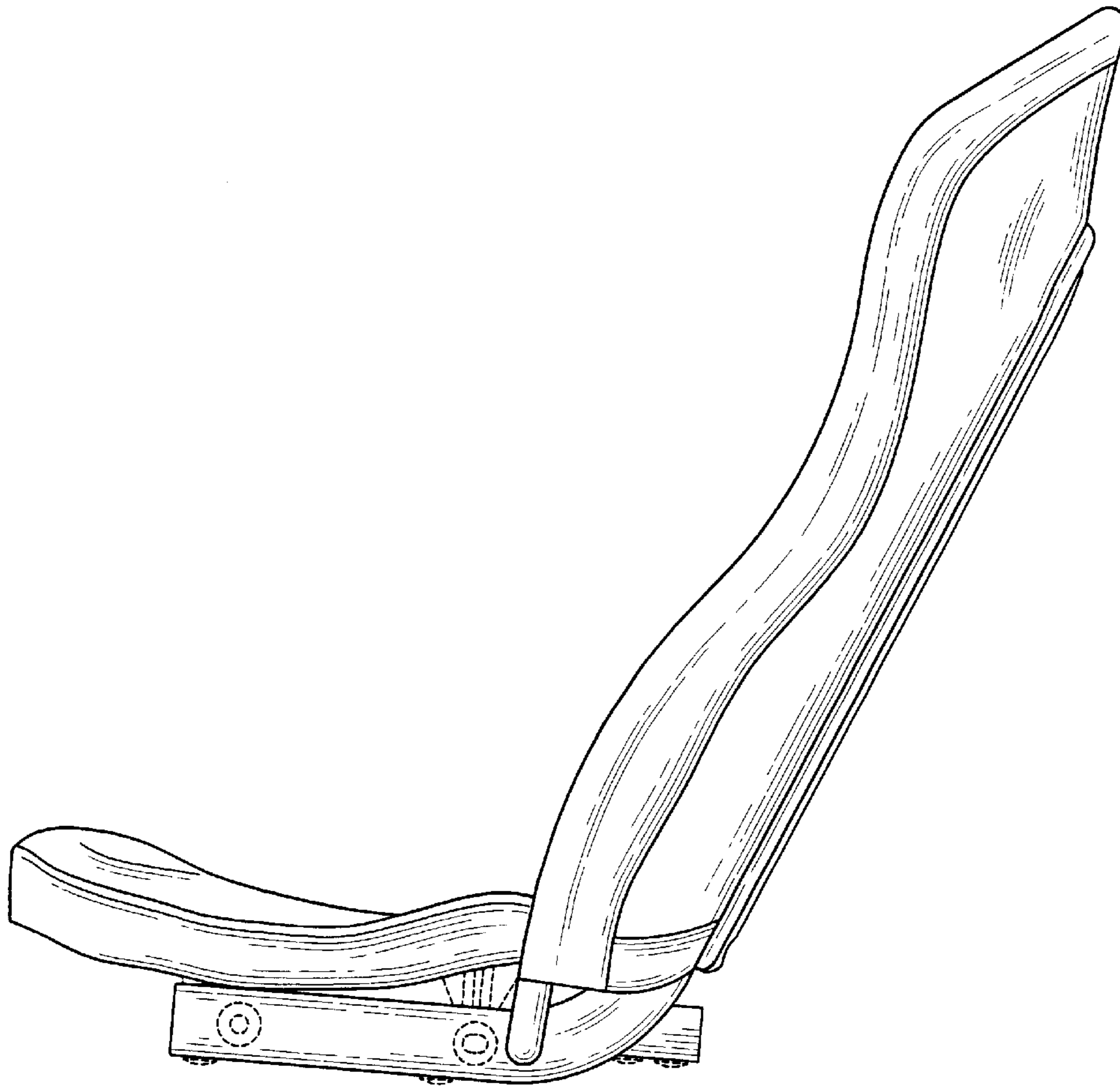

Fig. 5

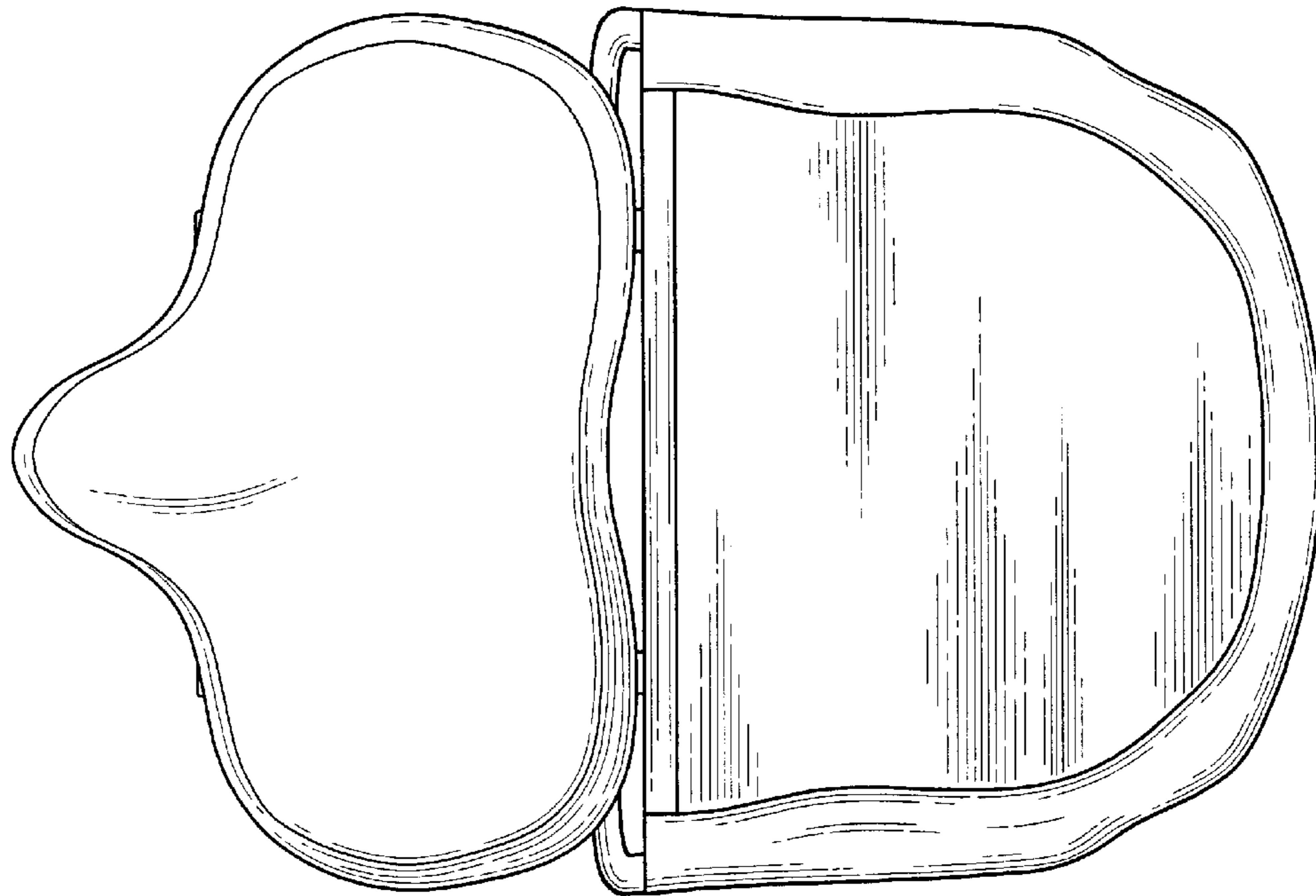

Fig. 6

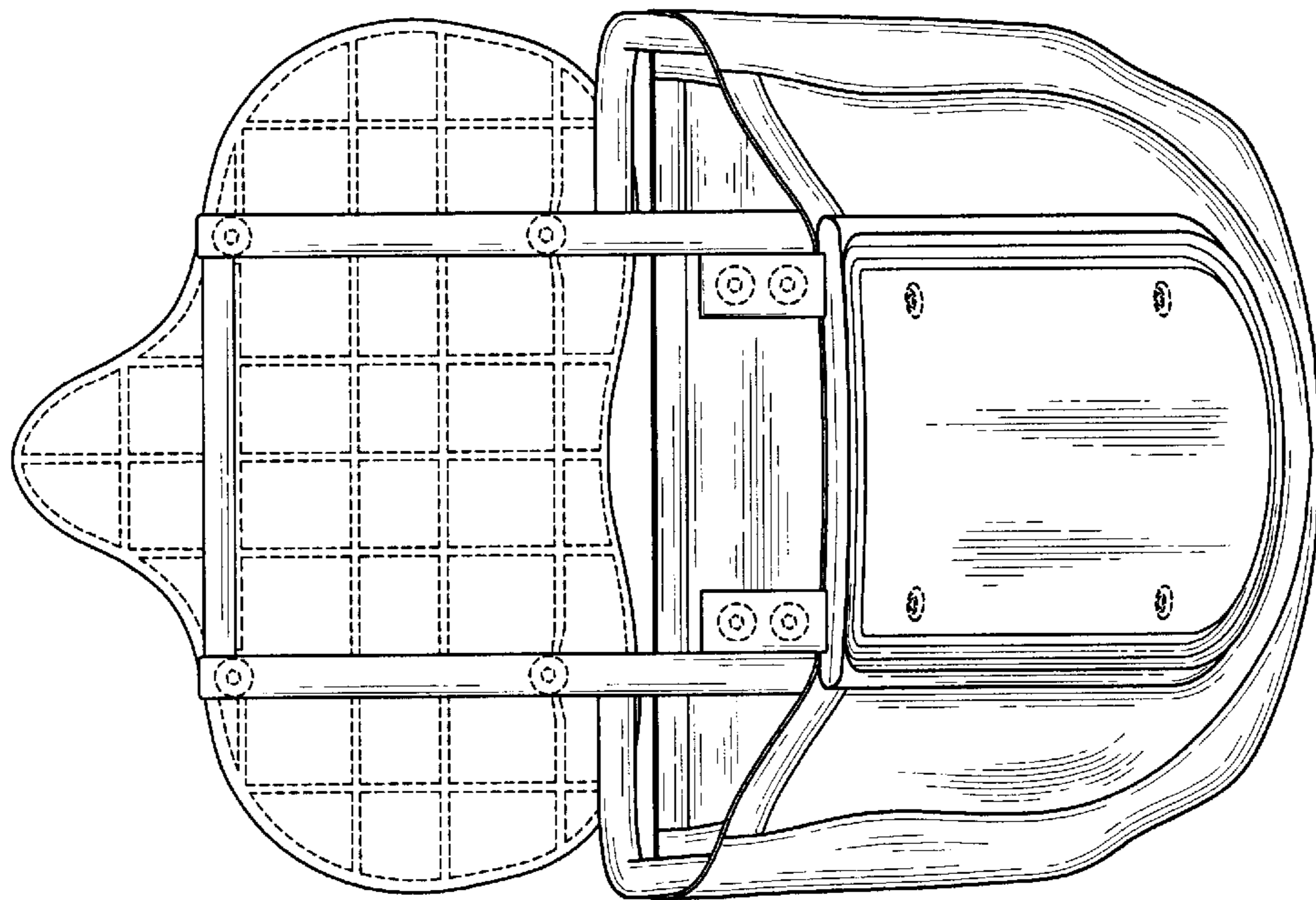

Fig. 7

UNITED STATES PATENT AND TRADEMARK OFFICE
CERTIFICATE OF CORRECTION

PATENT NO. : Des. 533,608 S
APPLICATION NO. : 29/223866
DATED : December 12, 2006
INVENTOR(S) : Robert J. Bingham, Jr. and Mark A. Zeh

Page 1 of 9

It is certified that error appears in the above-identified patent and that said Letters Patent is hereby corrected as shown below:

The title page showing the illustrative figure should be deleted to be replaced with the attached title page.

The drawing sheets, 1-7 consisting of Figs. 1-7, should be deleted to be replaced with drawing sheets, consisting of Figs. 1-7, as shown on the attached page.

Signed and Sealed this

Twentieth Day of March, 2007

A handwritten signature in black ink on a dotted background. The signature reads "Jon W. Dudas" in a cursive style.

JON W. DUDAS

Director of the United States Patent and Trademark Office

(12) **United States Design Patent** (10) Patent No.: **US D533,608 S**
 Bingham, Jr. et al. (45) Date of Patent: **** Dec. 12, 2006**

(54) **SEAT FOR EXERCISE MACHINES**
 (75) Inventors: Robert J. Bingham, Jr., Everett, WA (US); Mark A. Zeh, Munich (DE)
 (73) Assignee: LeMond Fitness, Inc., Woodinville, WA (US)
 (**) Term: 14 Years
 (21) Appl. No.: 29/223,866
 (22) Filed: Feb. 17, 2005
 (51) LOC (8) Cl. 21-02
 (52) U.S. Cl. D21/695; D6/501
 (58) Field of Classification Search D21/663, D21/664, 665, 667, 666, 690, 694, 695; 482/53, 482/54, 57, 58, 142; D6/500, 501, 502
 See application file for complete search history.

(56) **References Cited**
U.S. PATENT DOCUMENTS
 D320,826 S * 10/1991 Hildebrandt et al. D21/666
 D321,225 S * 10/1991 Solow et al. D21/695
 D340,961 S * 11/1993 Miller D21/695
 D353,422 S * 12/1994 Bostic et al. D21/665
 D386,023 S * 11/1997 Stumpf et al. D6/500
 D403,032 S * 12/1998 Huang D21/666
 D437,039 S * 1/2001 Yamazaki et al. D23/364
 D437,369 S * 2/2001 Teushi D21/666
 D461,210 S * 8/2002 Fen D21/656

D482,218 S * 11/2003 Lin D6/500
 D513,421 S * 1/2006 Nagao D21/656

OTHER PUBLICATIONS

Printouts from the Exercise Bike Superstore websight, dated back to Jan. 2004.*

* cited by examiner

Primary Examiner—Philip S. Hyder
 (74) *Attorney, Agent, or Firm*—George C. Rondeau, Jr.; Davis Wright Tremaine LLP

(57) **CLAIM**

The ornamental design for a seat for exercise machines, as shown and described.

DESCRIPTION

FIG. 1 is a front perspective view of a seat for exercise machines showing our new design.
 FIG. 2 is a rear perspective view thereof.
 FIG. 3 is a front elevational view thereof.
 FIG. 4 is a rear elevational view thereof.
 FIG. 5 is a left side elevational view thereof, the right side elevational view being a mirror image thereof.
 FIG. 6 is a top plan view thereof; and,
 FIG. 7 is a bottom plan view thereof.
 The broken lines are for illustrative purposes only and form no part of the claimed design.

1 Claim, 7 Drawing Sheets

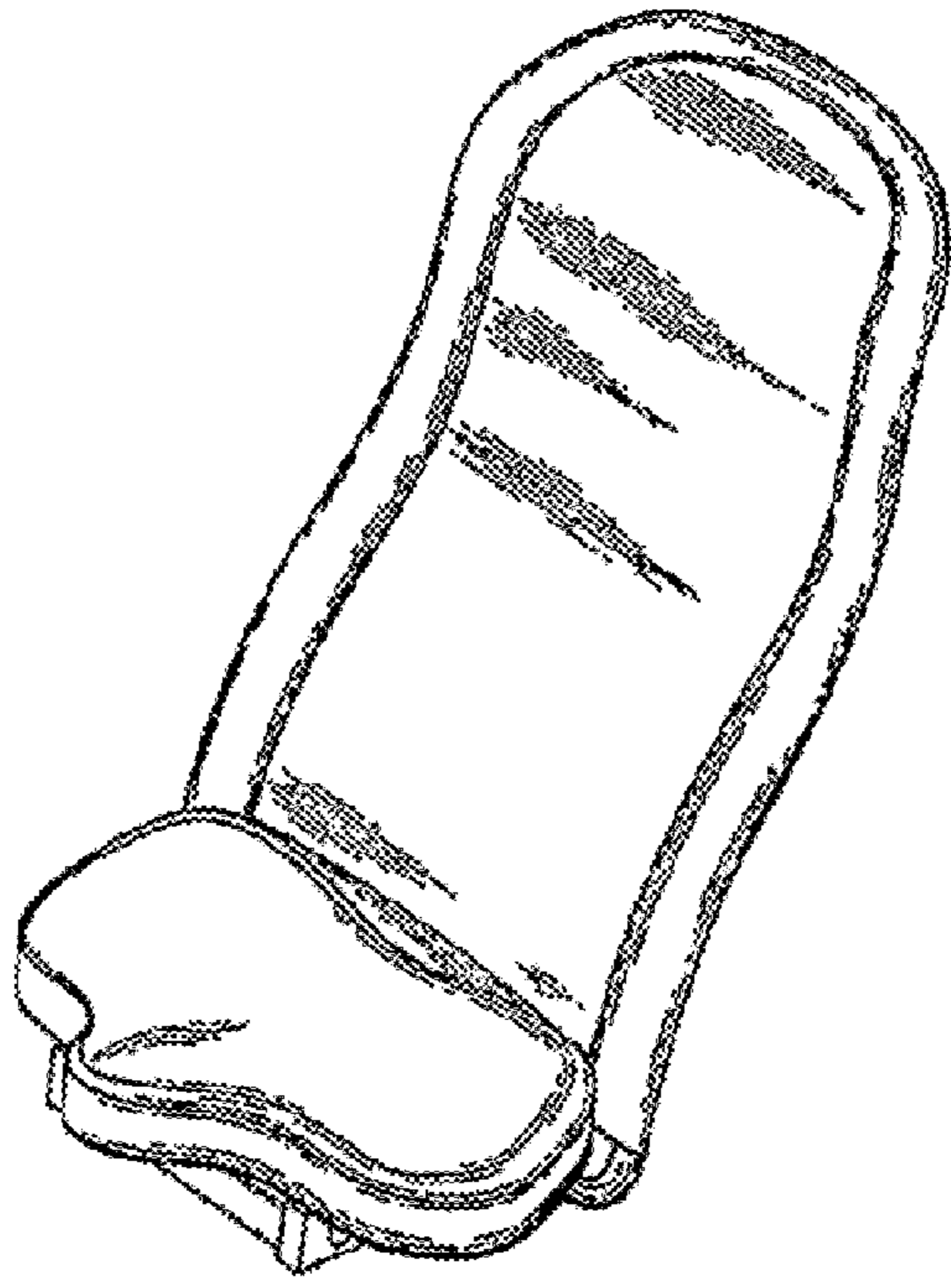

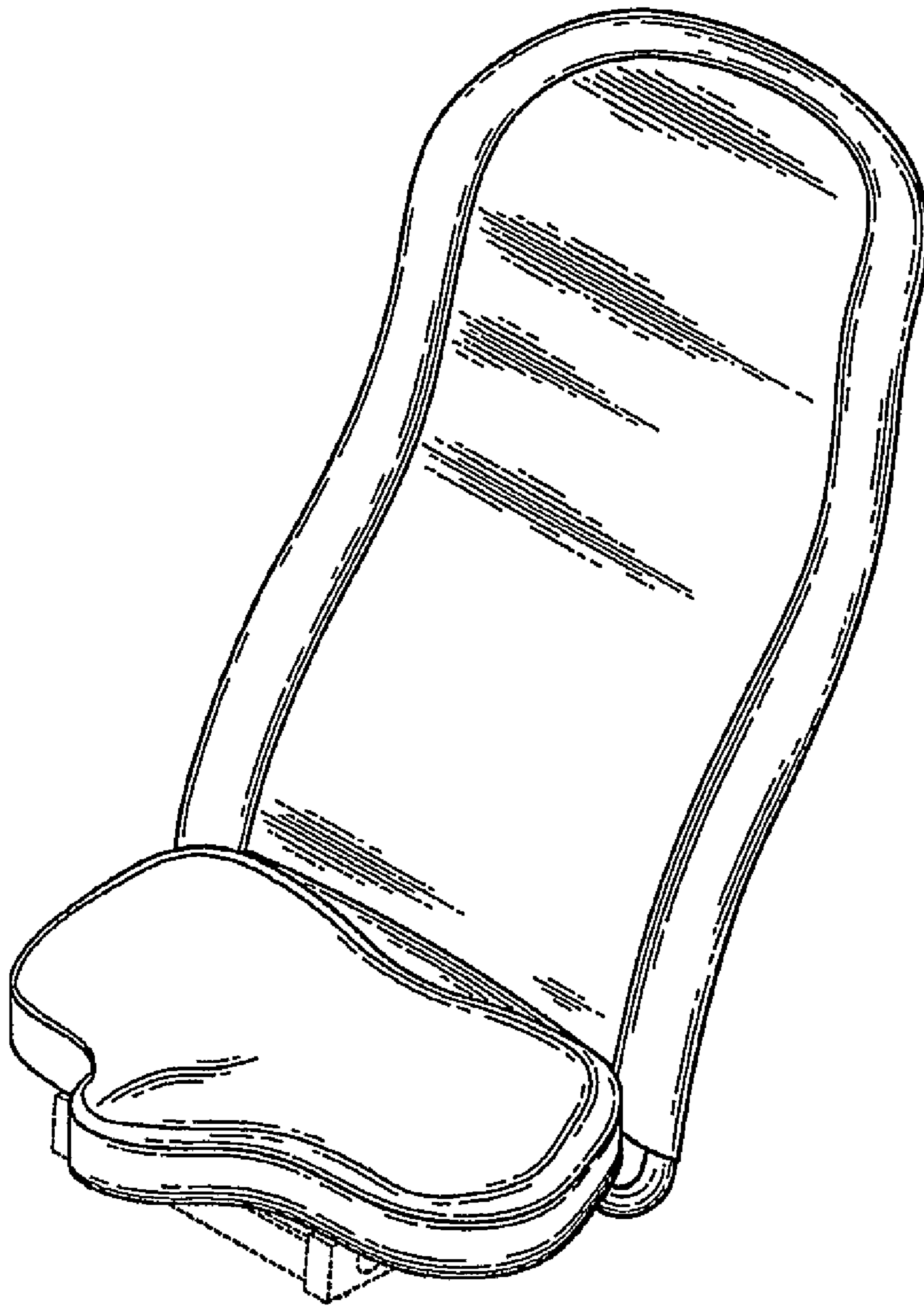

Fig. 1

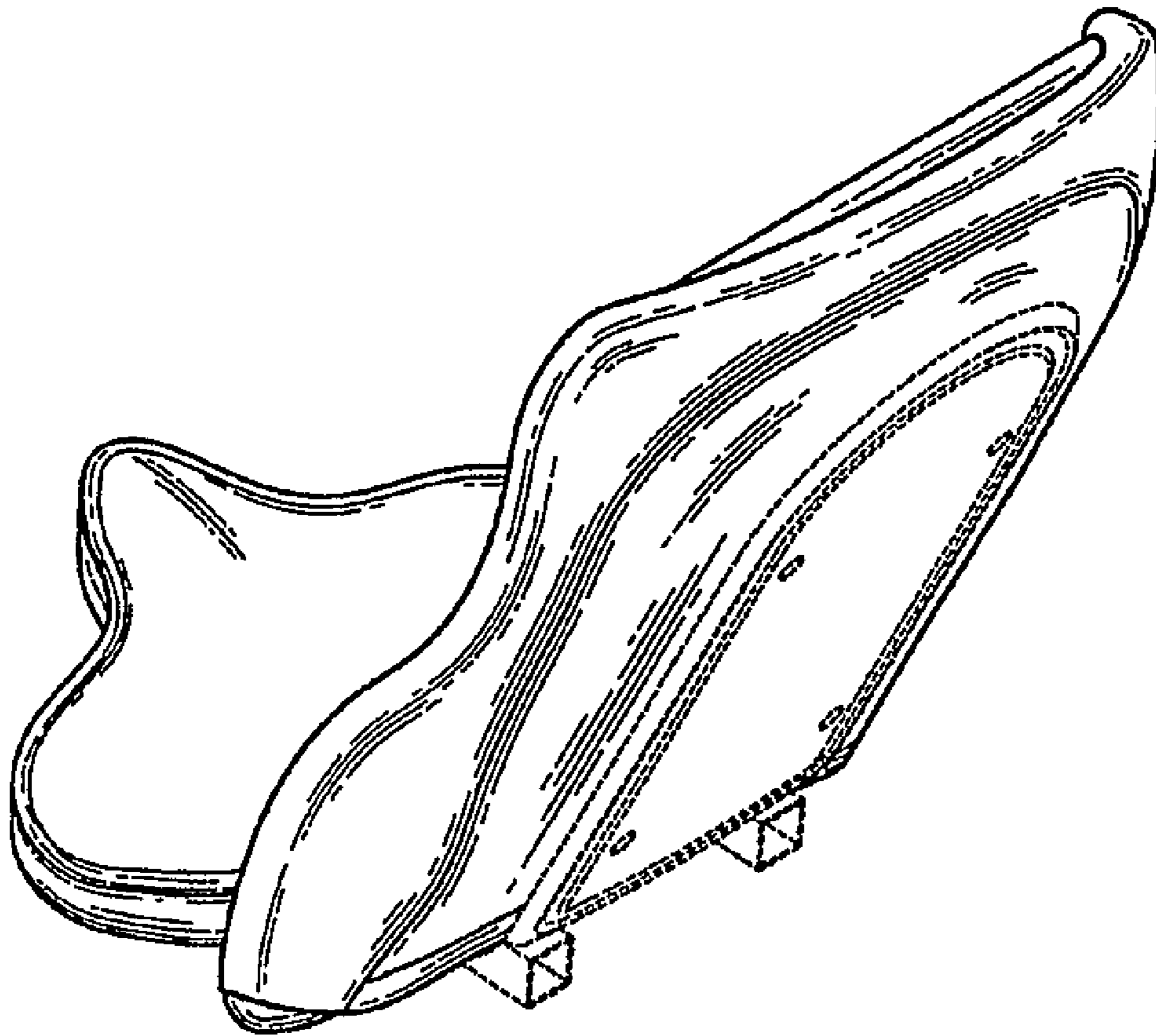

Fig. 2

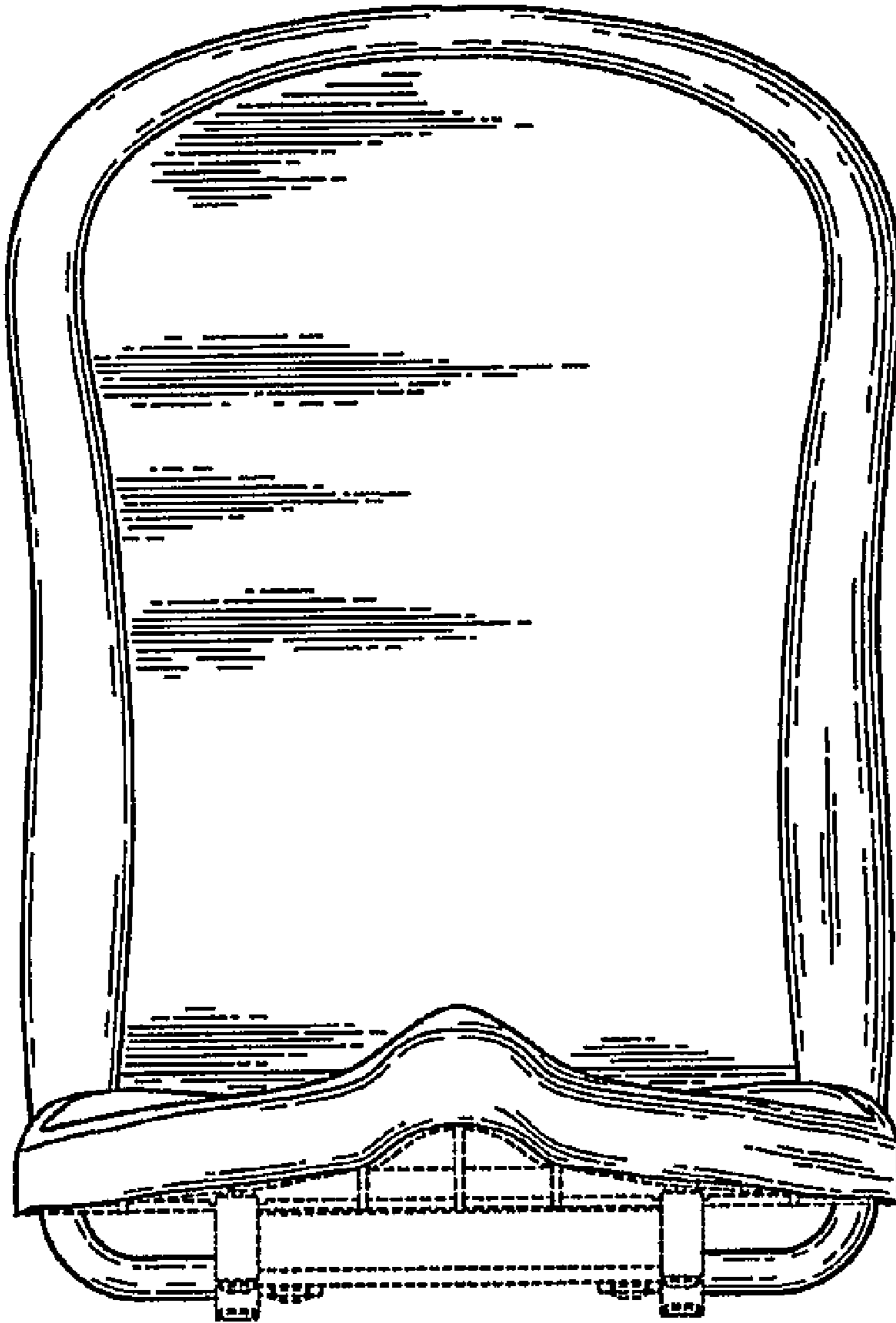

Fig. 3

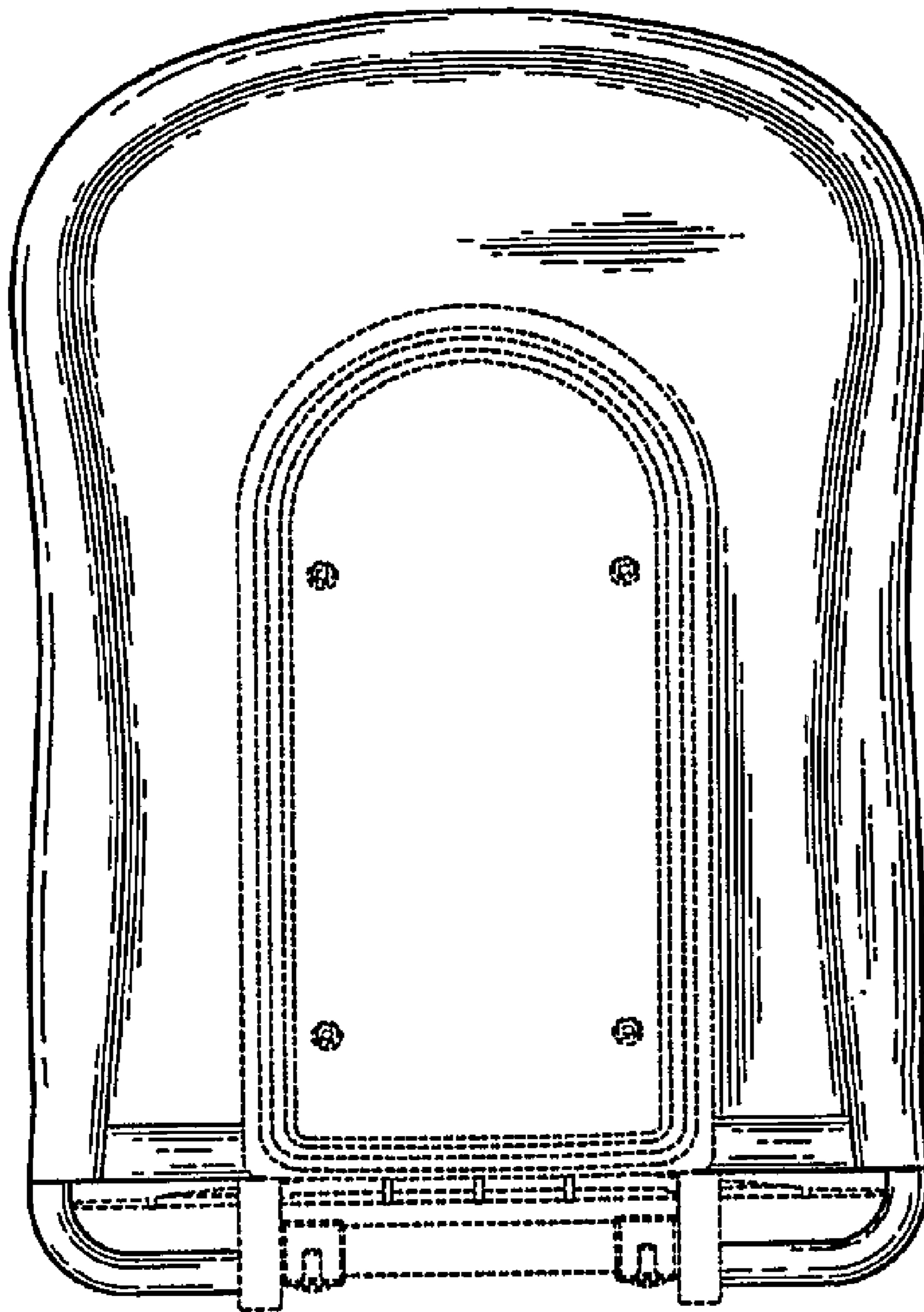

Fig. 4

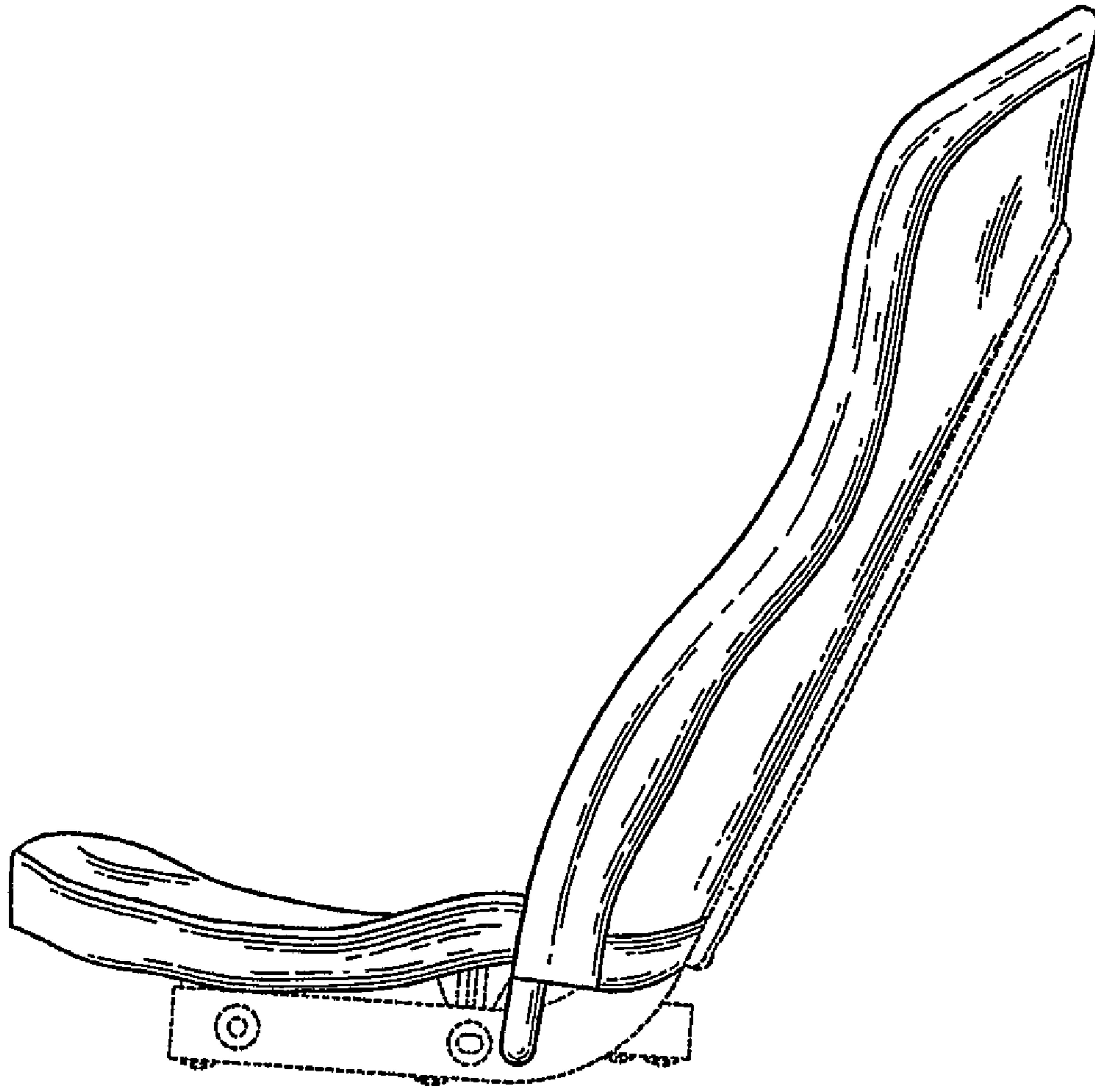

Fig. 5

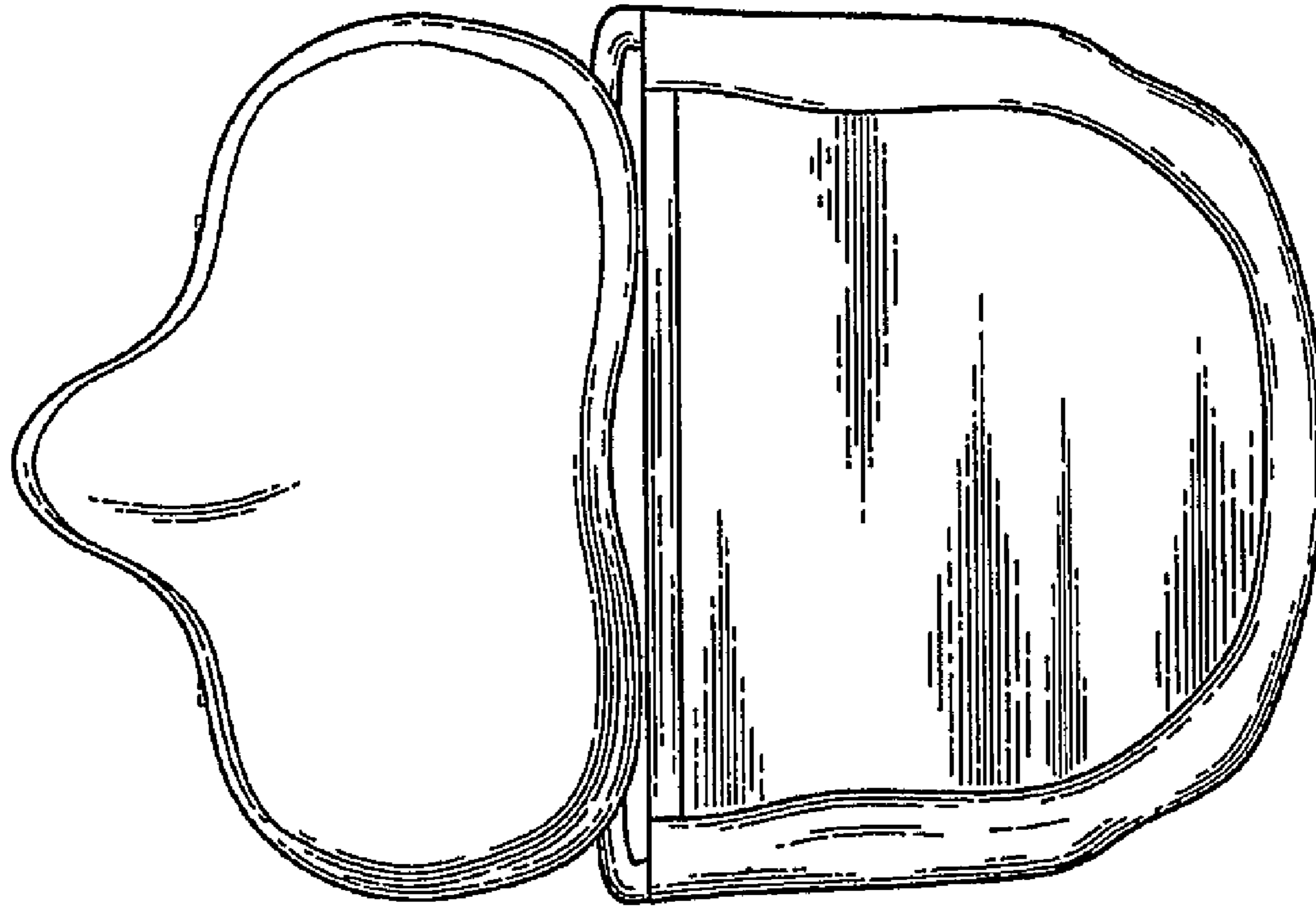

Fig. 6

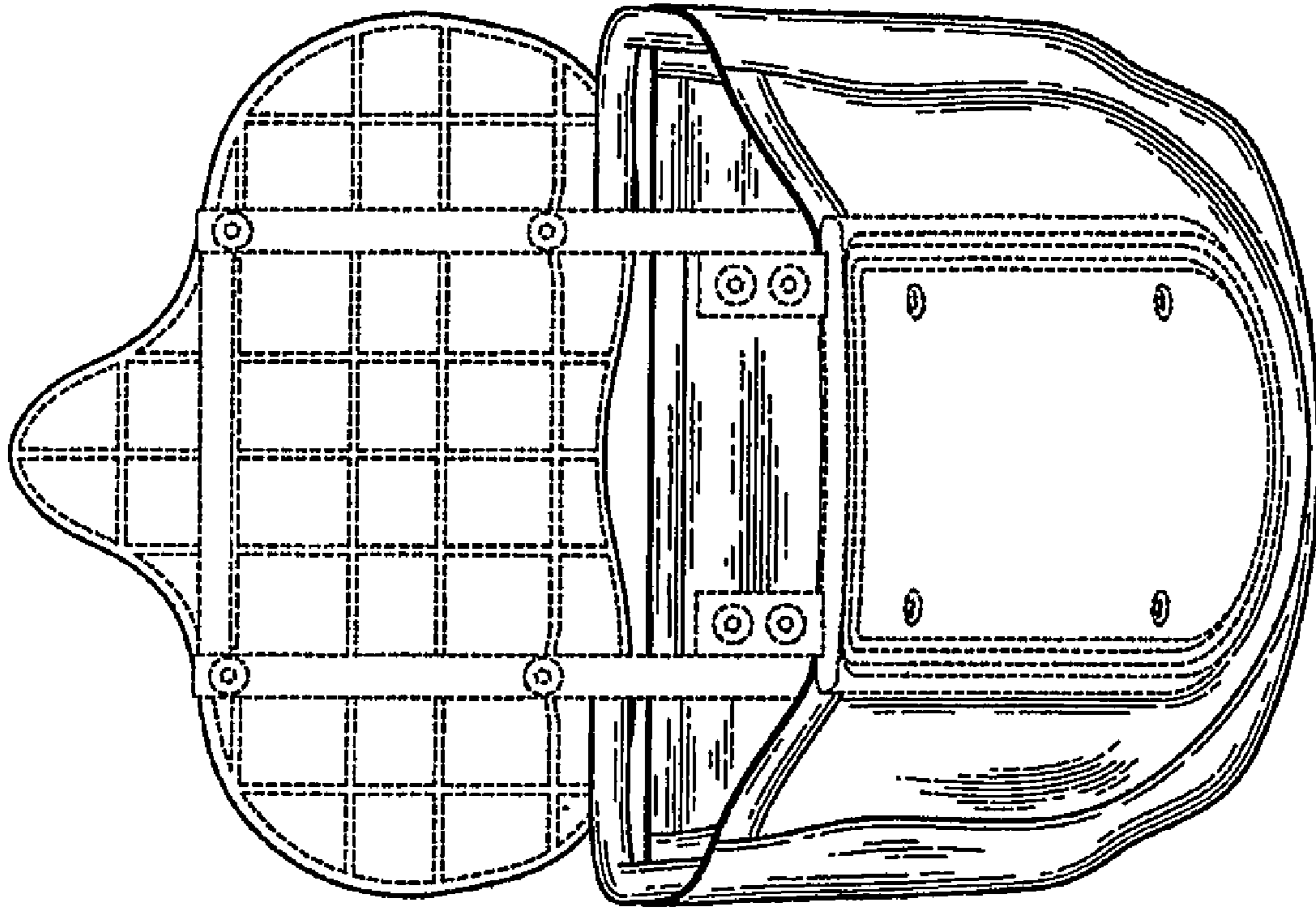

Fig. 7