



US00D533592S

(12) **United States Design Patent**  
**Cheng**

(10) **Patent No.:** **US D533,592 S**

(45) **Date of Patent:** **\*\* Dec. 12, 2006**

(54) **TRIANGULAR PEN**

(76) Inventor: **Dido Cheng**, Trade mart 4C-27, Taipei  
World Trade Center, No. 5, Sec. 5 Sinyi  
Rd., Sinyi District, Taipei City 110  
(TW)

(\*\*) Term: **14 Years**

(21) Appl. No.: **29/224,614**

(22) Filed: **Mar. 7, 2005**

(51) **LOC (8) Cl.** ..... **19-06**

(52) **U.S. Cl.** ..... **D19/50**

(58) **Field of Classification Search** ..... D19/36,  
D19/37, 41-51, 54-57; 24/11 R, 11 F, 11 P;  
401/52, 99, 100, 104, 105, 106, 107, 108,  
401/109, 192, 195, 243-247

See application file for complete search history.

(56) **References Cited**

**U.S. PATENT DOCUMENTS**

2,608,953 A \* 9/1952 Kollsman ..... 401/35  
D177,560 S \* 5/1956 Ensign et al. .... D19/49  
D319,845 S \* 9/1991 Grotsch et al. .... D19/48  
D323,186 S \* 1/1992 Clark et al. .... D19/48

D342,546 S \* 12/1993 Song ..... D19/50  
D418,541 S \* 1/2000 Mayer ..... D19/50  
D450,768 S \* 11/2001 Keda ..... D19/48  
D463,822 S \* 10/2002 Keda ..... D19/48  
D474,241 S \* 5/2003 Hasegawa ..... D19/51  
D484,912 S \* 1/2004 Briggl ..... D19/55  
D509,853 S \* 9/2005 Anand ..... D19/51

\* cited by examiner

*Primary Examiner*—Elizabeth A. Albert

(74) *Attorney, Agent, or Firm*—Rosenberg, Klein & Lee

(57) **CLAIM**

The ornamental design for a triangular pen, as shown.

**DESCRIPTION**

FIG. 1 is a front elevational view of a triangular pen showing my new design;

FIG. 2 is a rear elevational view thereof;

FIG. 3 is a right side elevational view thereof;

FIG. 4 is a left side elevational view thereof;

FIG. 5 is a top plan view thereof;

FIG. 6 is a bottom plan view thereof; and,

FIG. 7 is a front-right-top perspective view thereof.

**1 Claim, 7 Drawing Sheets**

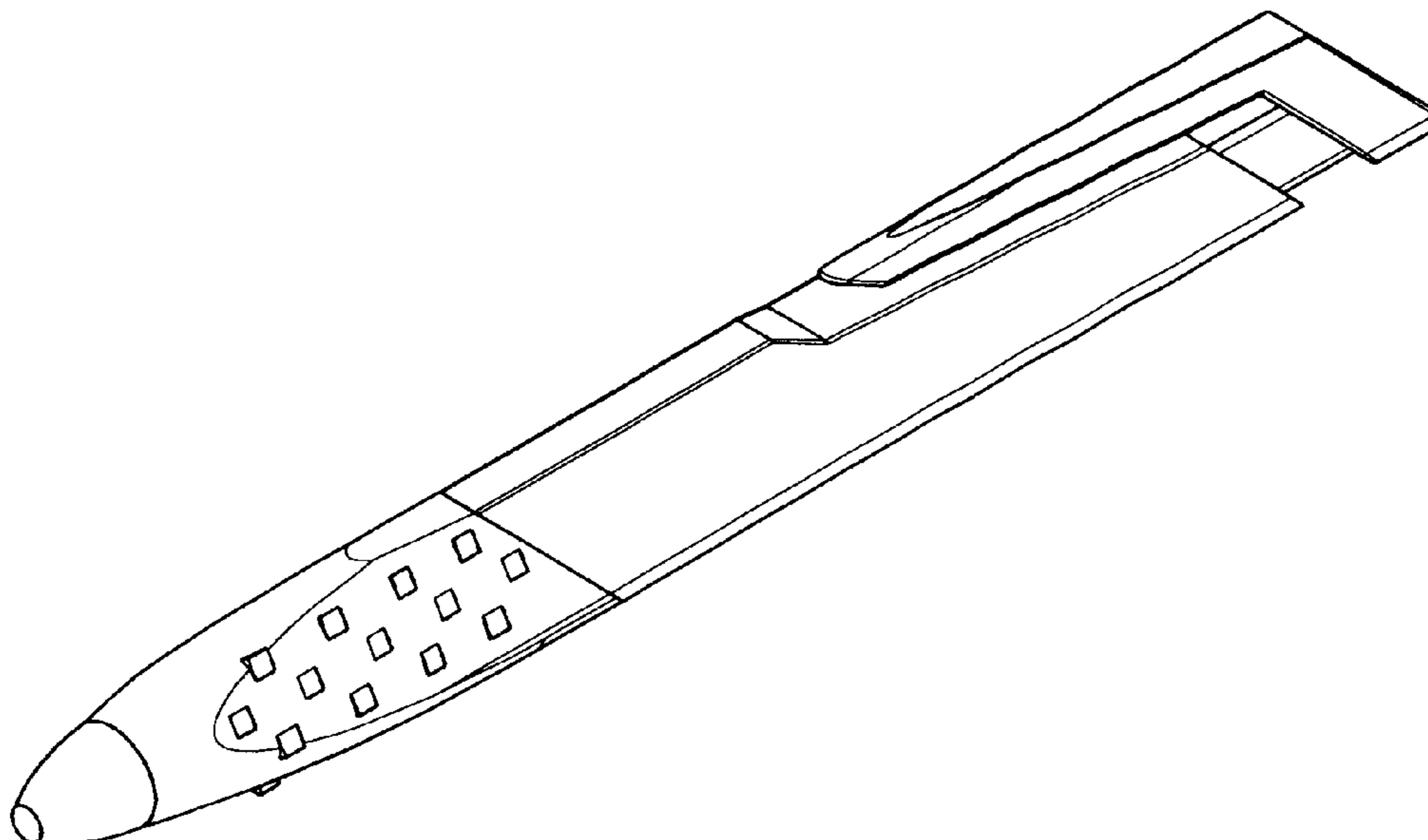
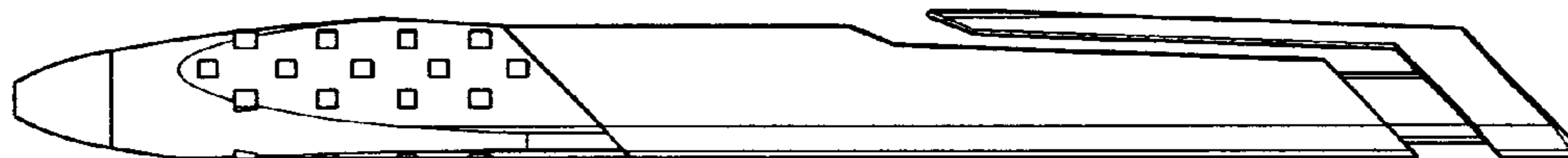

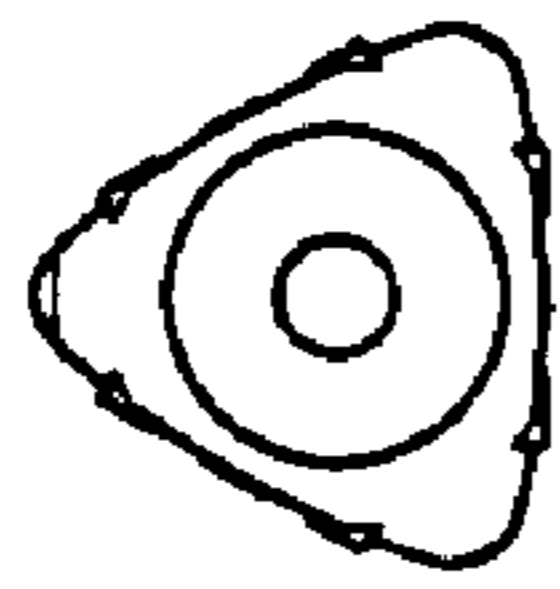

FIG. 1

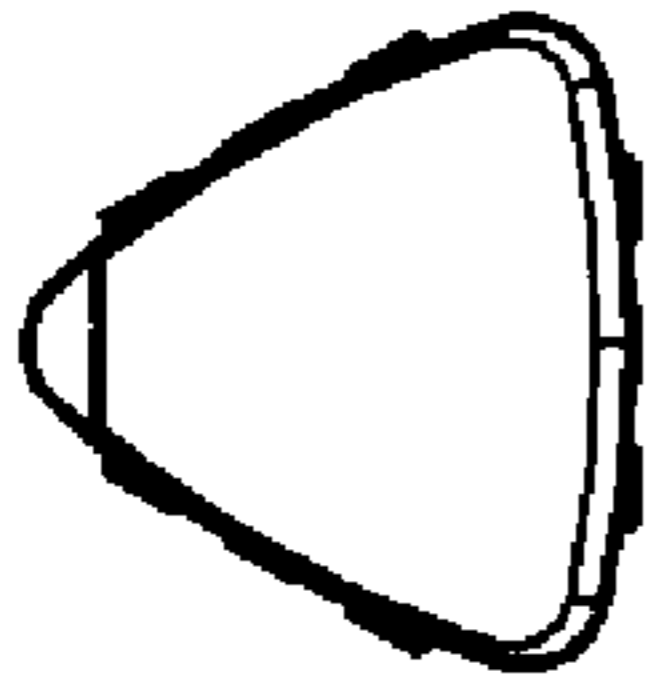

FIG. 2

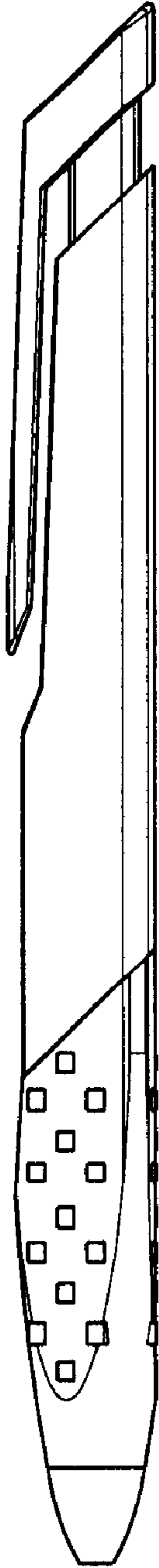

FIG. 3

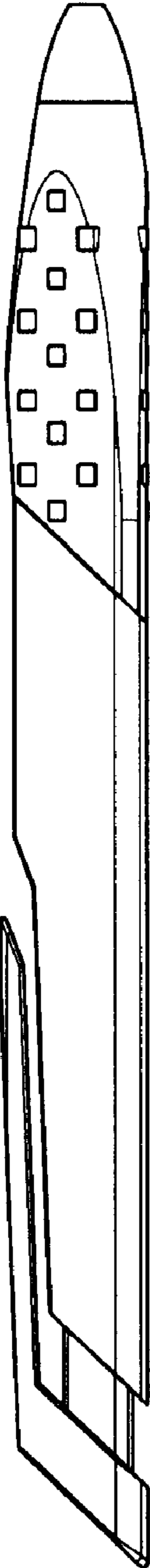

FIG. 4

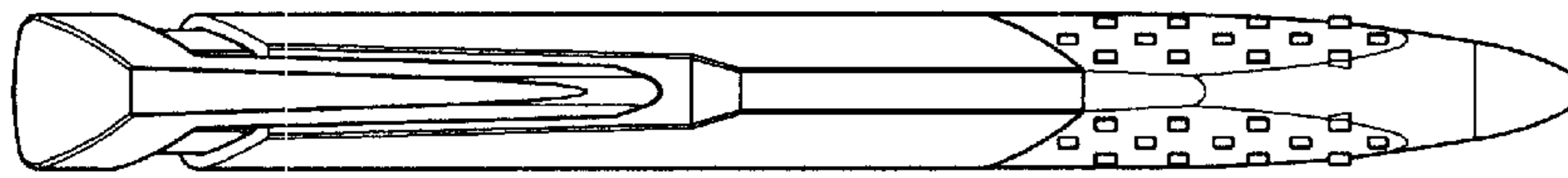

FIG. 5

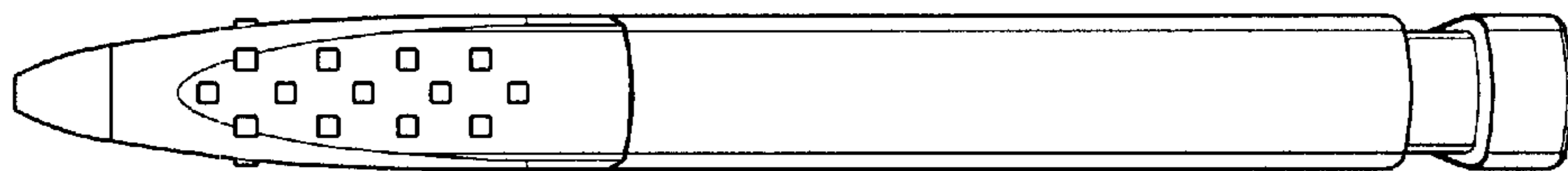

FIG. 6

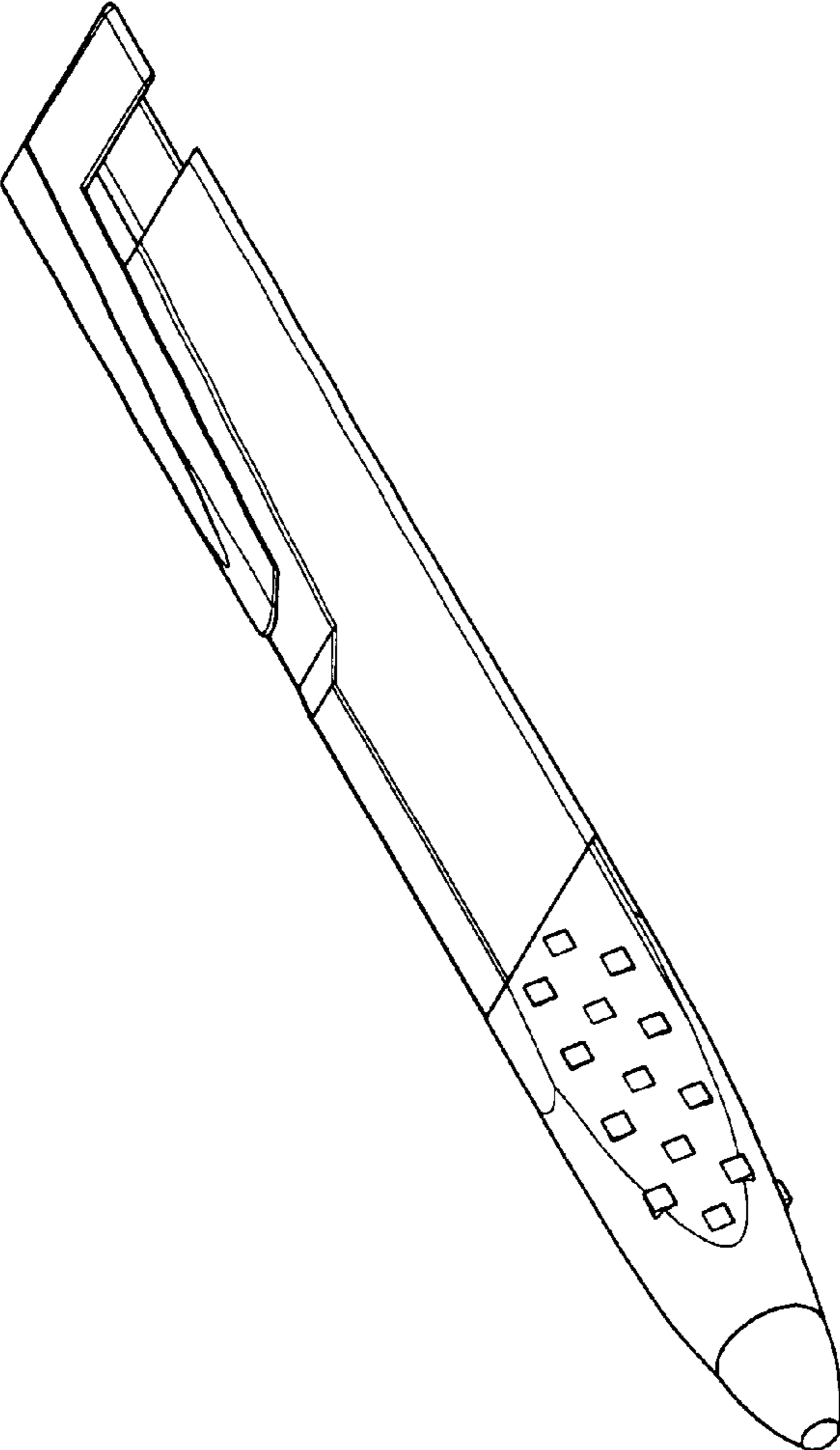

FIG. 7