



US00D533553S

(12) **United States Design Patent**
Xu et al.

(10) **Patent No.:** **US D533,553 S**

(45) **Date of Patent:** **** Dec. 12, 2006**

(54) **COMPUTER CASE**

(75) Inventors: **Ting Xu**, Shenzhen (CN); **Chun-Chi Liang**, Tu-Cheng (TW); **Jing-Renn Yu**, Tu-Cheng (TW); **Yun-Dong Xu**, Shenzhen (CN)

(73) Assignee: **Hon Hai Precision Ind. Co., Ltd.**, Taipei Hsien (TW)

(**) Term: **14 Years**

(21) Appl. No.: **29/231,933**

(22) Filed: **Jun. 9, 2005**

(30) **Foreign Application Priority Data**

Apr. 8, 2005 (CN) 2005 3 0056611

(51) **LOC (8) Cl.** **14-02**

(52) **U.S. Cl.** **D14/349**

(58) **Field of Classification Search** D14/300-302, D14/308, 349, 310-314, 351-356; D13/162, D13/184, 199; 312/223.1-223.3; 360/99.01-99.12; 361/690-696; 369/34.01, 36.01
See application file for complete search history.

(56) **References Cited**

U.S. PATENT DOCUMENTS

5,934,774 A * 8/1999 Wu et al. 312/223.2

D445,419 S * 7/2001 Lee et al. D14/349
D487,743 S * 3/2004 Kim D14/349
D497,162 S * 10/2004 Neal et al. D14/349

* cited by examiner

Primary Examiner—Freda S. Nunn

(74) *Attorney, Agent, or Firm*—Wei Te Chung

(57) **CLAIM**

The ornamental design for a computer case, as shown and described.

DESCRIPTION

FIG. 1 is a perspective view of a computer case of our new design;

FIG. 2 is a front elevational view thereof;

FIG. 3 is a rear elevational view thereof, broken lines shown in FIG. 3 being for illustrative purposes only and forming no part of the claimed design;

FIG. 4 is a left side elevational view thereof;

FIG. 5 is a right side elevational view thereof;

FIG. 6 is a top plan view thereof; and,

FIG. 7 is a bottom plan view thereof.

1 Claim, 7 Drawing Sheets

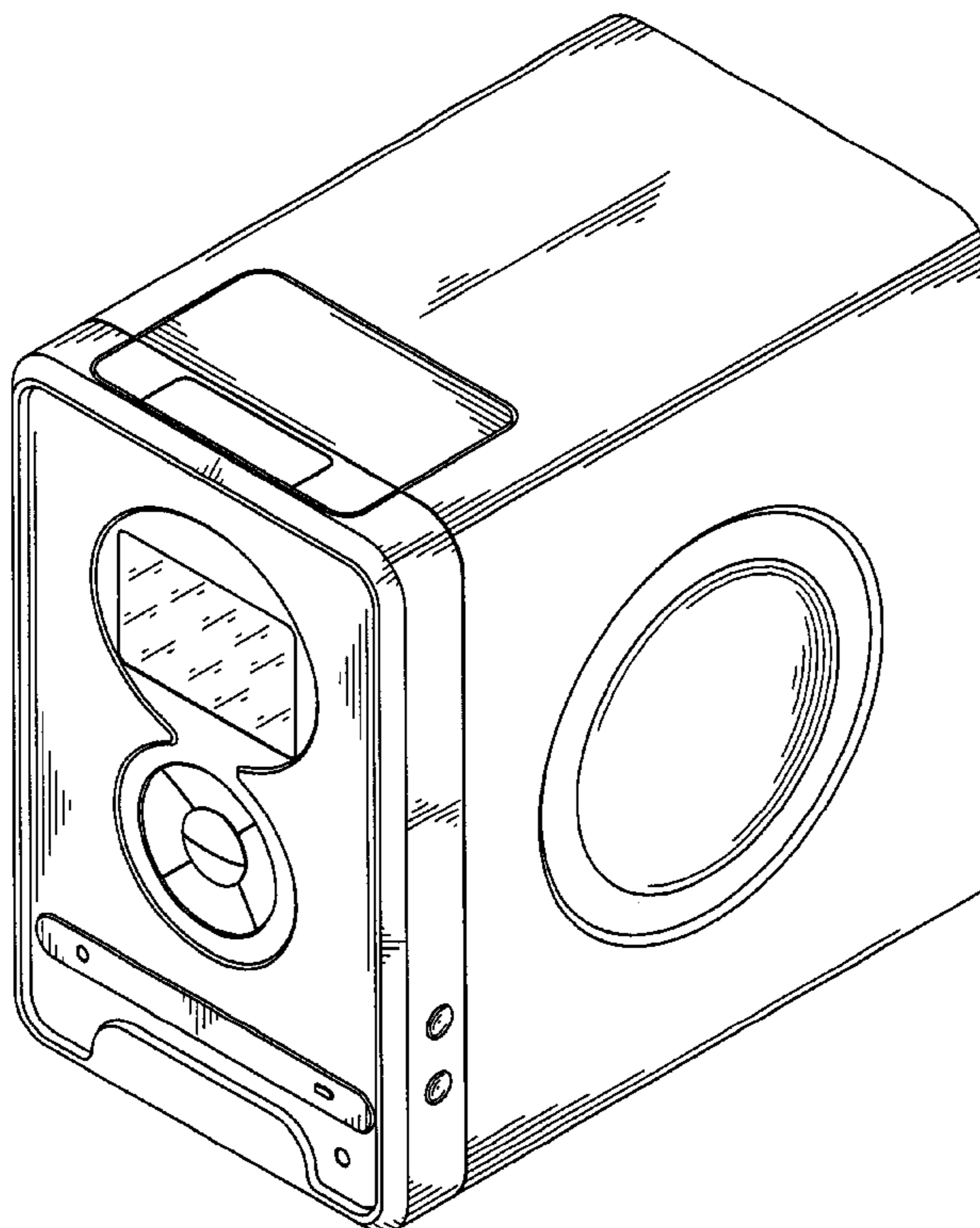

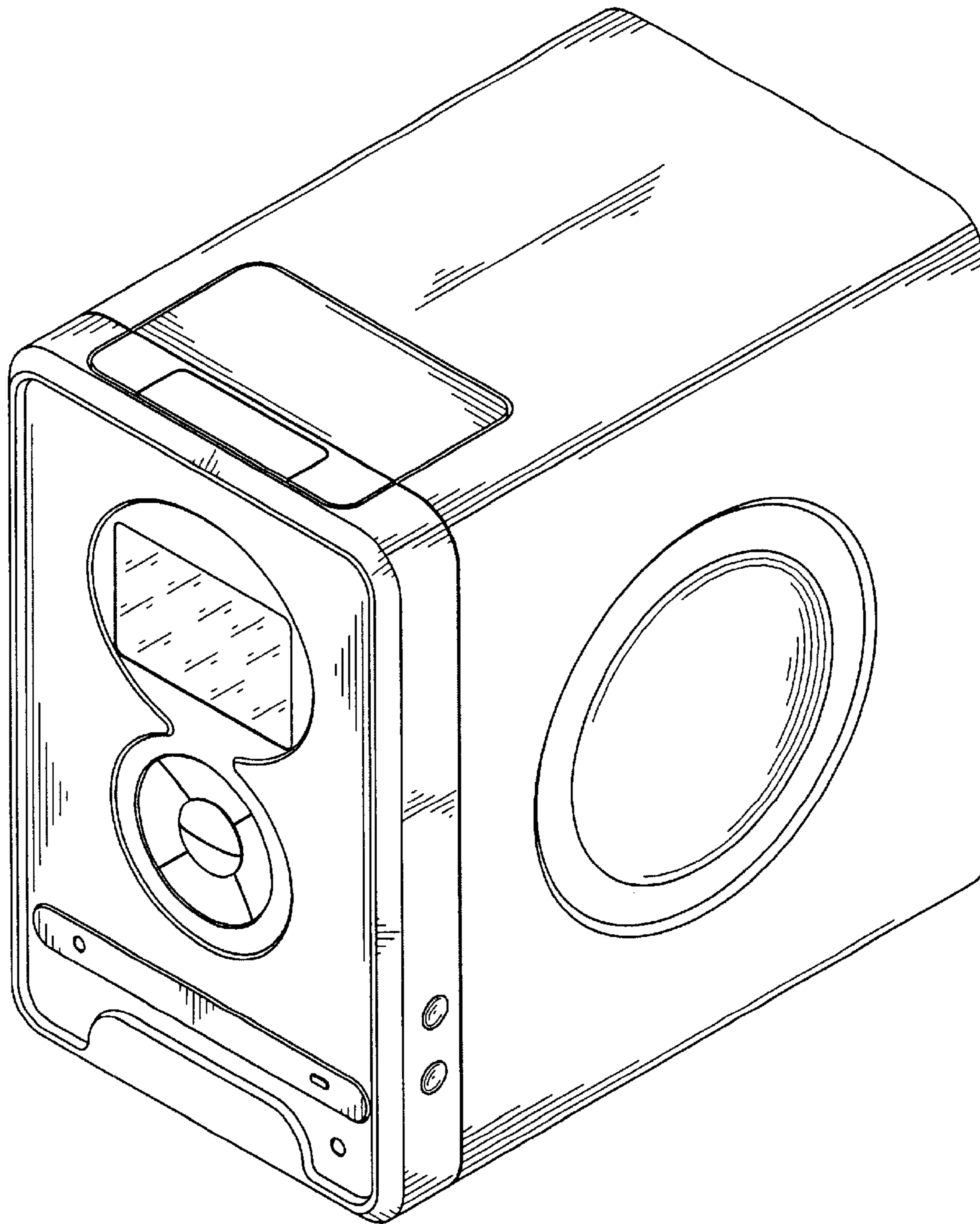

FIG. 1

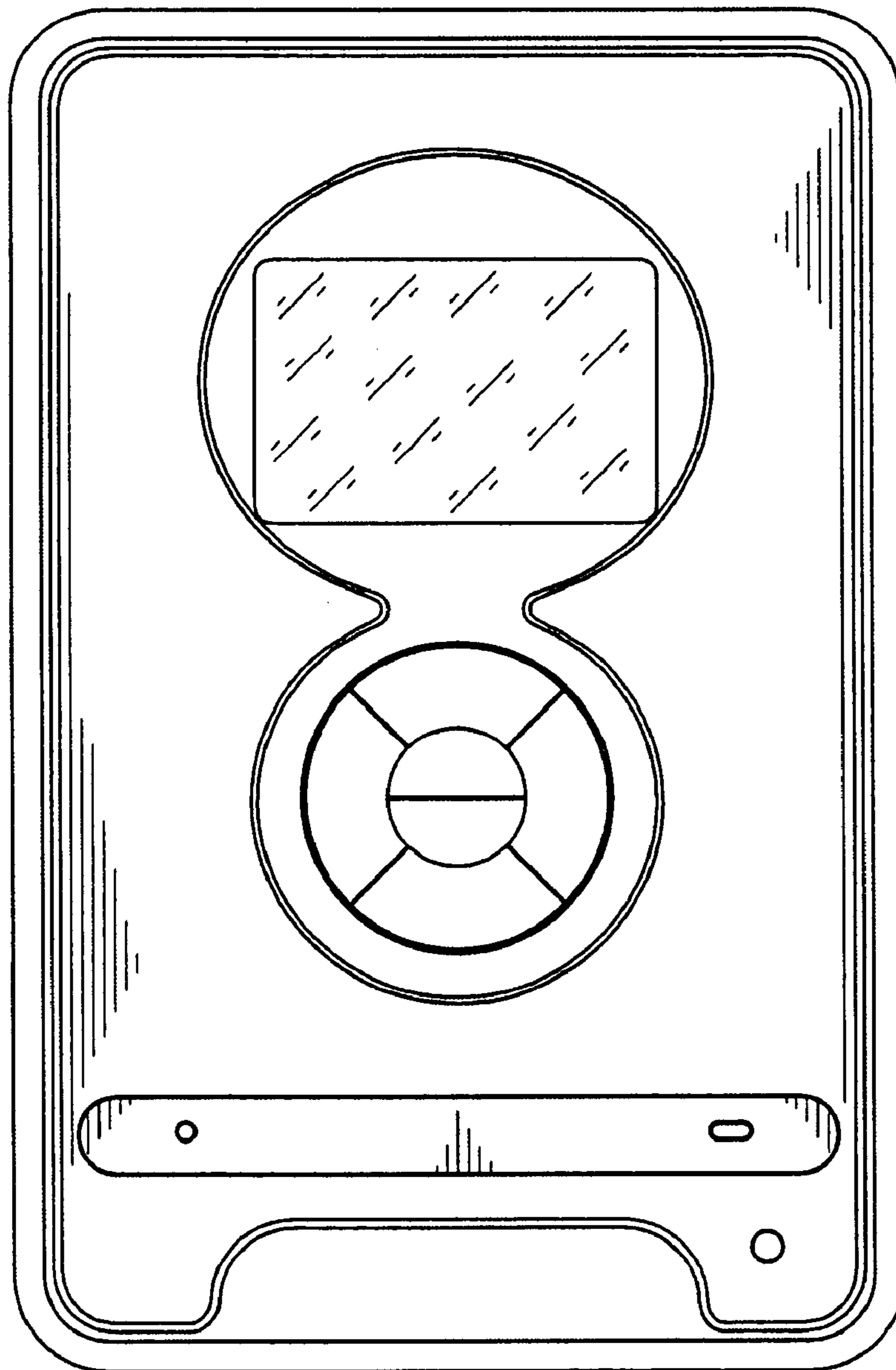

FIG. 2

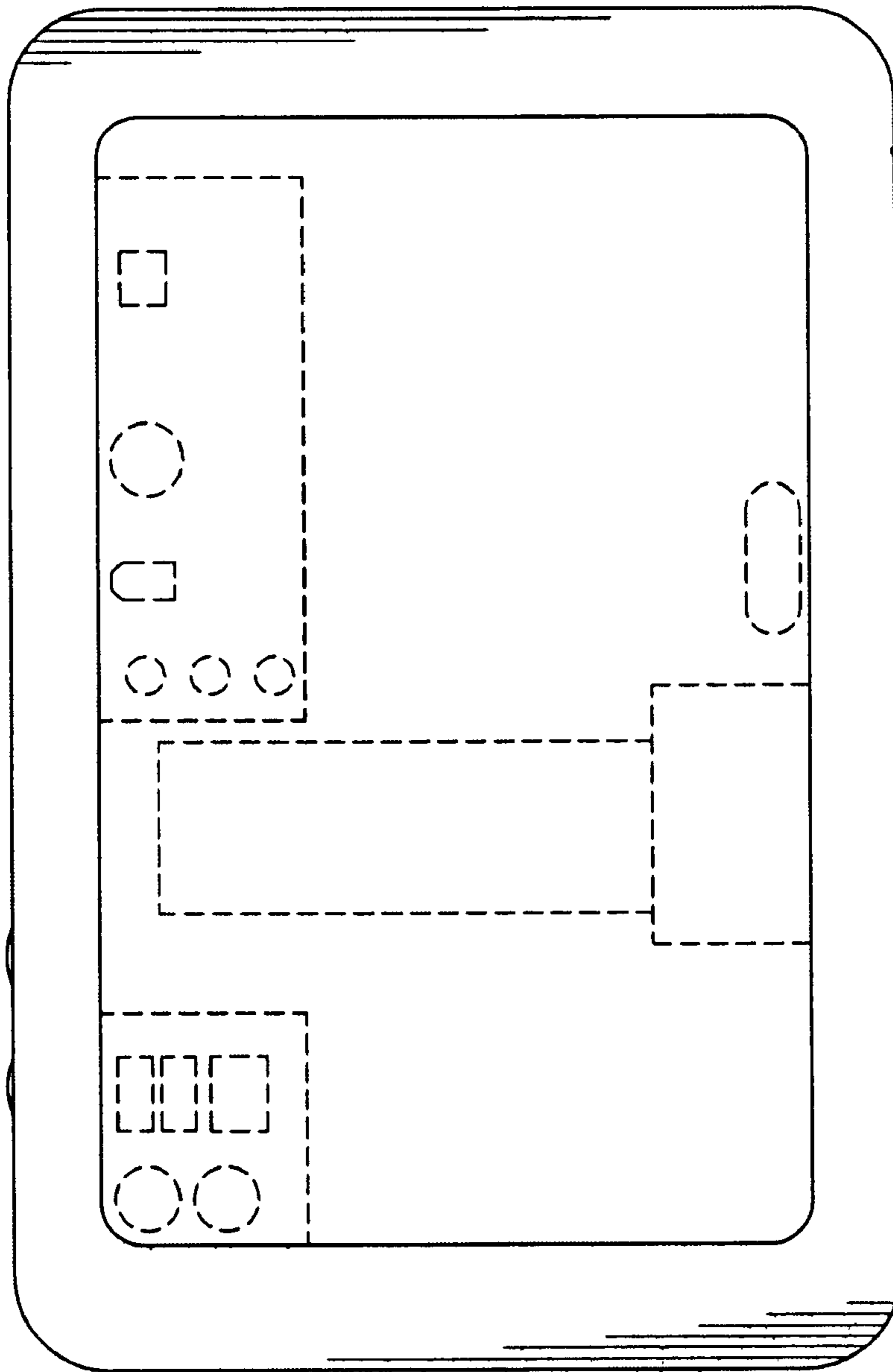

FIG. 3

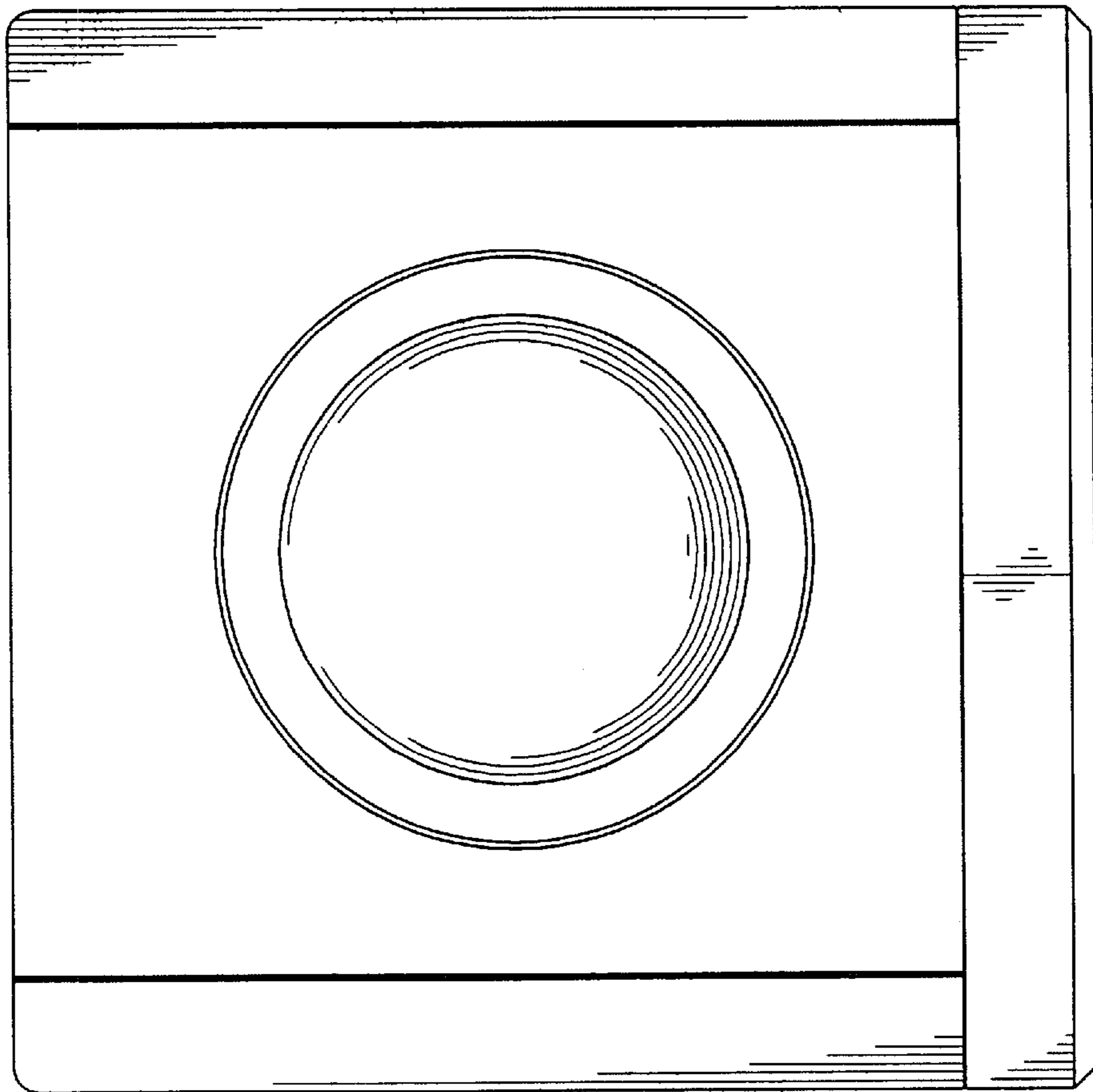

FIG. 4

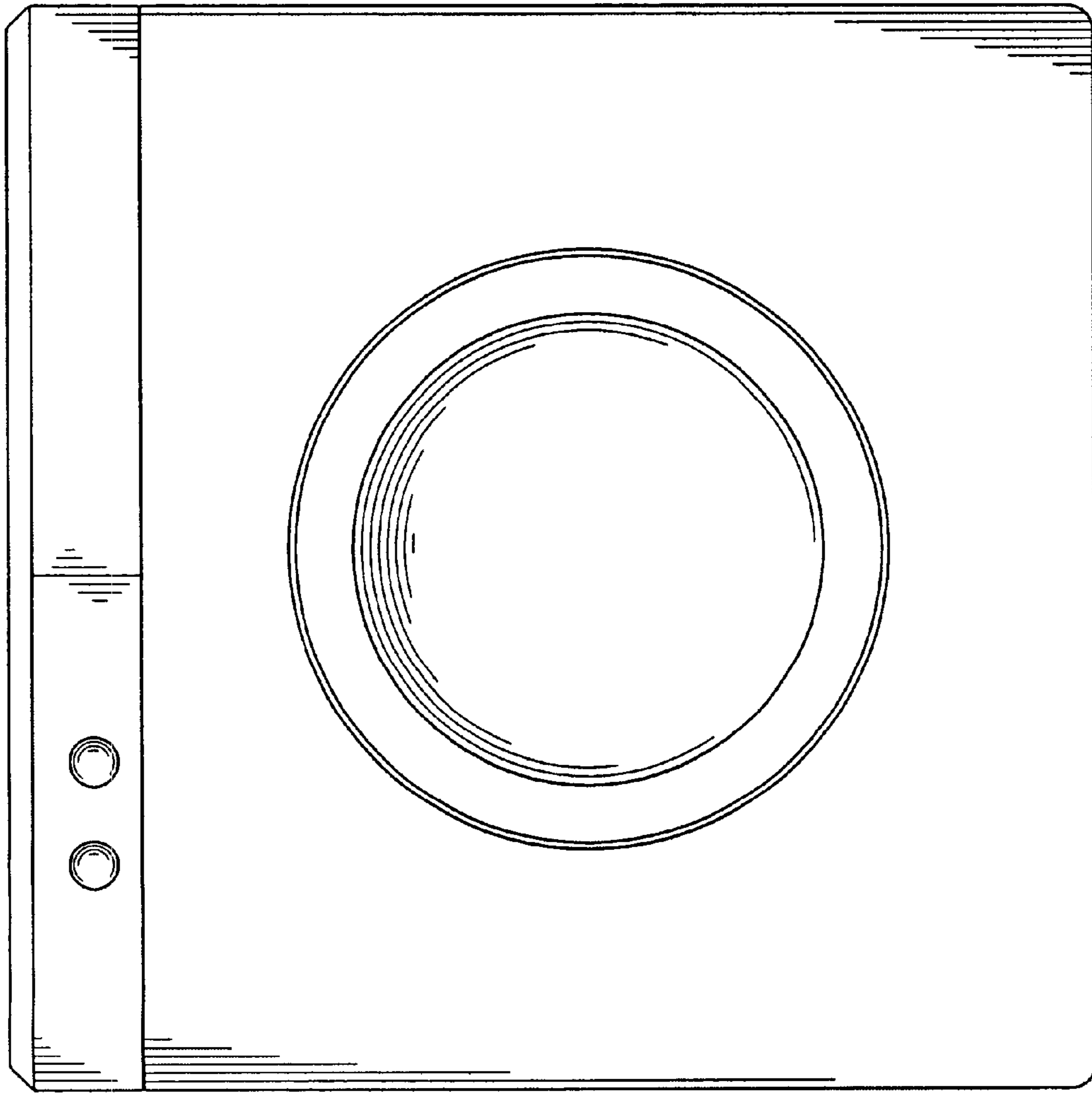

FIG. 5

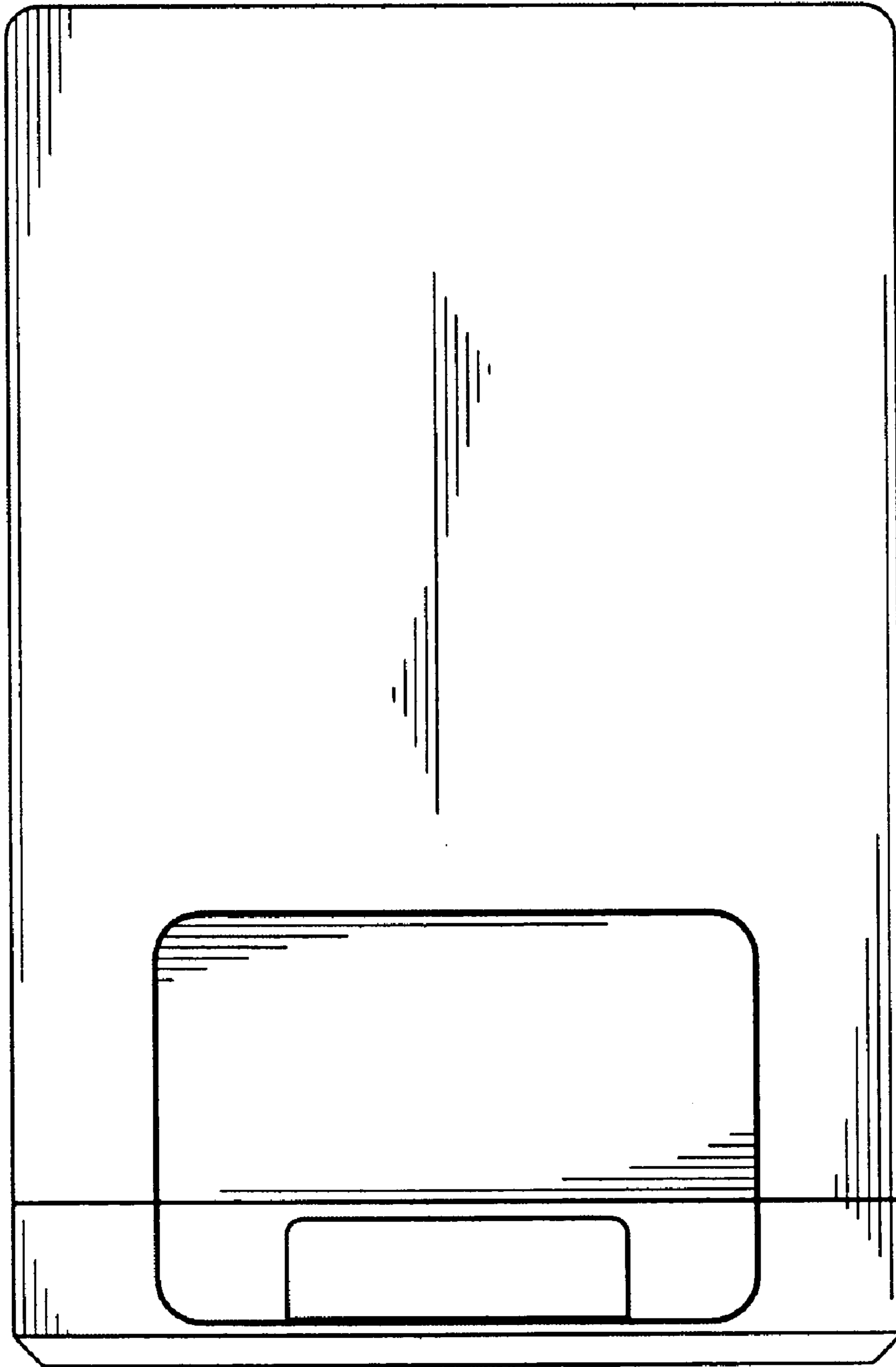

FIG. 6

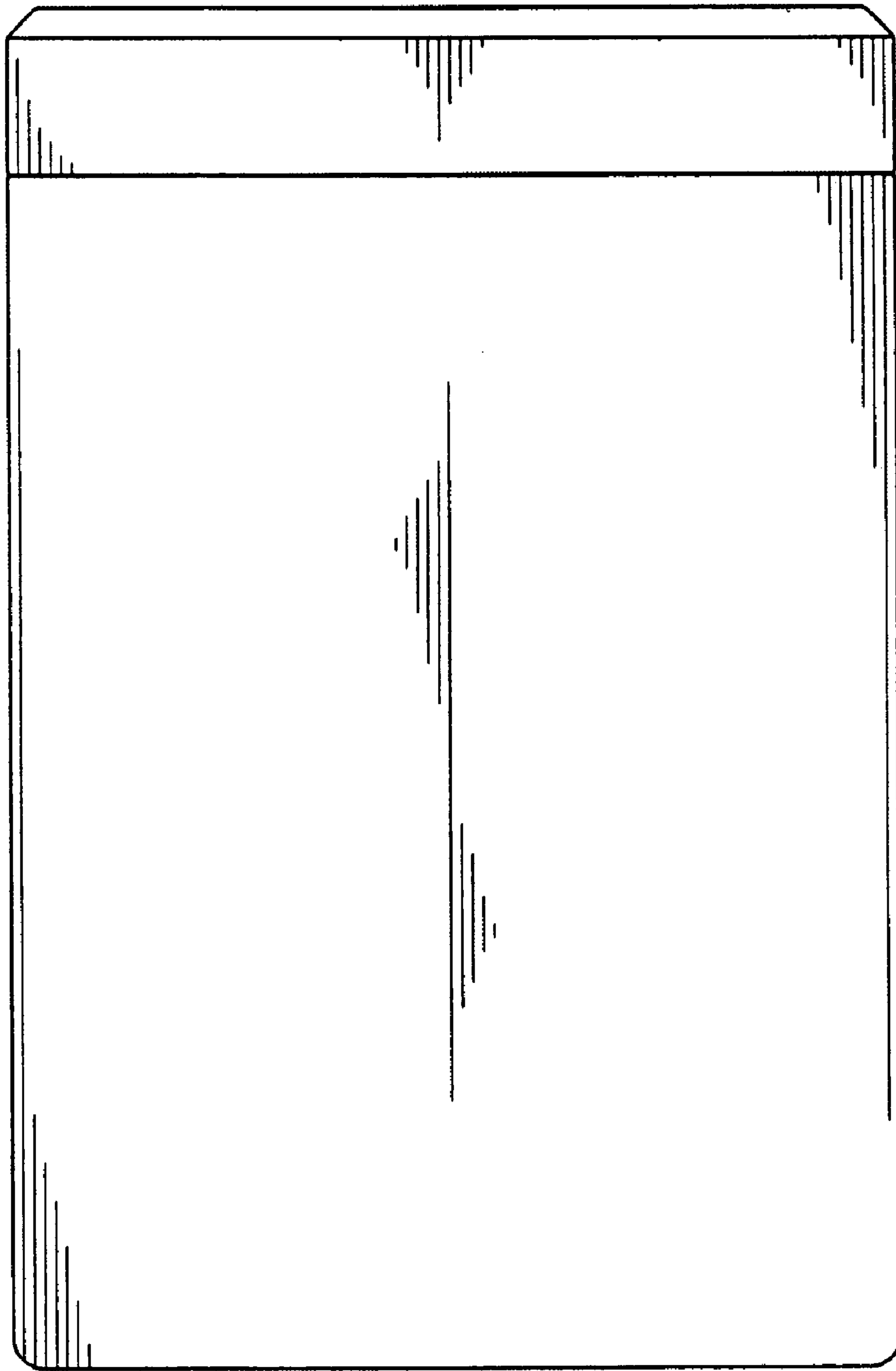

FIG. 7