



US00D533466S

(12) **United States Design Patent**
Wonderley et al.

(10) **Patent No.:** **US D533,466 S**

(45) **Date of Patent:** **** Dec. 12, 2006**

- (54) **SHAVING RAZOR TRAY**
- (75) Inventors: **Jeffrey W. Wonderley**, Fort Defiance, VA (US); **Neil S. White**, Nottinghamshire (GB)
- (73) Assignee: **American Safety Razor**, Verona, VA (US)
- (**) Term: **14 Years**
- (21) Appl. No.: **29/241,274**
- (22) Filed: **Oct. 24, 2005**
- (51) **LOC (8) Cl.** **09-03**
- (52) **U.S. Cl.** **D9/749**
- (58) **Field of Classification Search** D9/749, D9/737, 748, 415, 416, 430-432; D6/512, D6/526; D28/73, 44, 99; D3/201, 205; 206/228, 206/240, 352, 775, 208, 493, 354-360
See application file for complete search history.

- D316,962 S 5/1991 Gray
- D320,342 S * 10/1991 Gray D9/749
- 5,113,586 A 5/1992 Lazarchik et al.
- D335,413 S 5/1993 Lizanetz et al.
- D335,990 S 6/1993 Lizanetz et al.
- D336,426 S * 6/1993 Fisher D9/749
- 5,228,580 A 7/1993 Grange
- 5,242,063 A 9/1993 Ericksen et al.
- 5,265,759 A 11/1993 Coffin
- 5,407,066 A 4/1995 Grange
- 5,429,241 A 7/1995 Althaus
- D364,060 S * 11/1995 Lai D6/526
- 5,518,114 A 5/1996 Kohring et al.
- D370,375 S 6/1996 Murgida et al.

(Continued)

FOREIGN PATENT DOCUMENTS

- EP 0 290 965 A1 5/1988
- FR 2 491 877 4/1982
- GB 2 107 175 A 4/1983

Primary Examiner—Stella Reid
Assistant Examiner—Mark Goodwin
 (74) *Attorney, Agent, or Firm*—McDermott Will & Emery LLP

(56) **References Cited**
U.S. PATENT DOCUMENTS

- 1,536,468 A 5/1925 Behrman
- 1,912,531 A 6/1933 Lawson
- 1,996,406 A 4/1935 Chadwick
- 2,432,818 A 12/1947 Schults
- 2,883,062 A 4/1959 Rosemark
- 3,366,268 A 1/1968 Struck
- D216,635 S 2/1970 Grange et al.
- 3,754,326 A 8/1973 Glaberson
- 3,822,781 A 7/1974 Braginetz
- 3,869,183 A 3/1975 Frank, Jr.
- D237,666 S 11/1975 Iten
- 3,970,194 A 7/1976 Iten
- 4,019,793 A 4/1977 Gerding
- D251,896 S 5/1979 Nissen
- D253,167 S 10/1979 Fournier et al.
- D256,995 S * 9/1980 Kiraly D9/749
- 4,450,980 A 5/1984 Clabby et al.
- 4,611,716 A 9/1986 Sorlien
- 4,742,909 A 5/1988 Apprille, Jr. et al.
- D313,175 S 12/1990 Motta et al.

(57) **CLAIM**

The ornamental design for a shaving razor tray, substantially as shown and described.

DESCRIPTION

FIG. 1 is a front perspective view of the shaving razor tray showing the new design;
 FIG. 2 is a front view of the shaving razor tray;
 FIG. 3 is a rear view of the shaving razor tray;
 FIG. 4 is a side view of the shaving razor tray;
 FIG. 5 is another side view of the shaving razor tray;
 FIG. 6 is a top view of the shaving razor tray;
 FIG. 7 is a bottom view of the shaving razor tray; and,
 FIG. 8 is a front perspective view of the shaving razor tray of FIGS. 1-7 with the broken line showing of a razor stored in the tray forming no part of the claimed design.

1 Claim, 6 Drawing Sheets

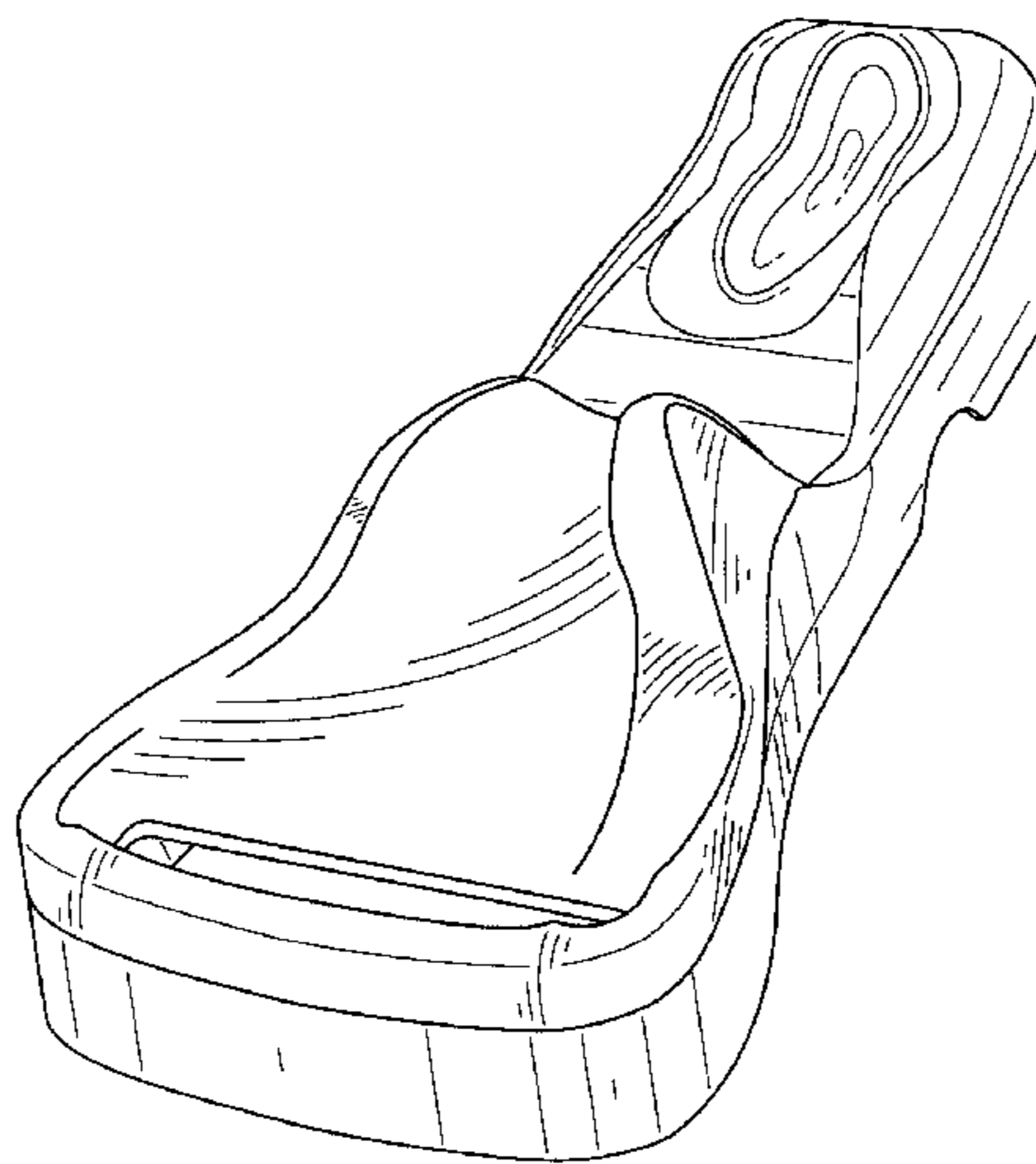

US D533,466 S

Page 2

U.S. PATENT DOCUMENTS

D370,844 S	*	6/1996	Shurtleff et al.	D9/749	5,903,978 A	*	5/1999	Prochaska et al.	30/34.05
5,623,955 A		4/1997	Sewell		D425,296 S	*	5/2000	Shurtleff	D3/205
5,738,020 A		4/1998	Correia		D433,187 S	*	10/2000	Dettman	D28/44
5,782,346 A	*	7/1998	Gray et al.	206/228	6,415,517 B1	*	7/2002	Worrick, III	30/541
D399,421 S	*	10/1998	Gray	D9/749	D494,796 S	*	8/2004	Dansreau et al.	D6/526
D401,145 S	*	11/1998	Gray	D9/749	6,946,624 B1	*	9/2005	Tomassetti	219/386
5,839,198 A		11/1998	McCoy		D519,644 S	*	4/2006	Jankowski et al.	D24/222
D409,799 S	*	5/1999	Prochaska	D28/73					

* cited by examiner

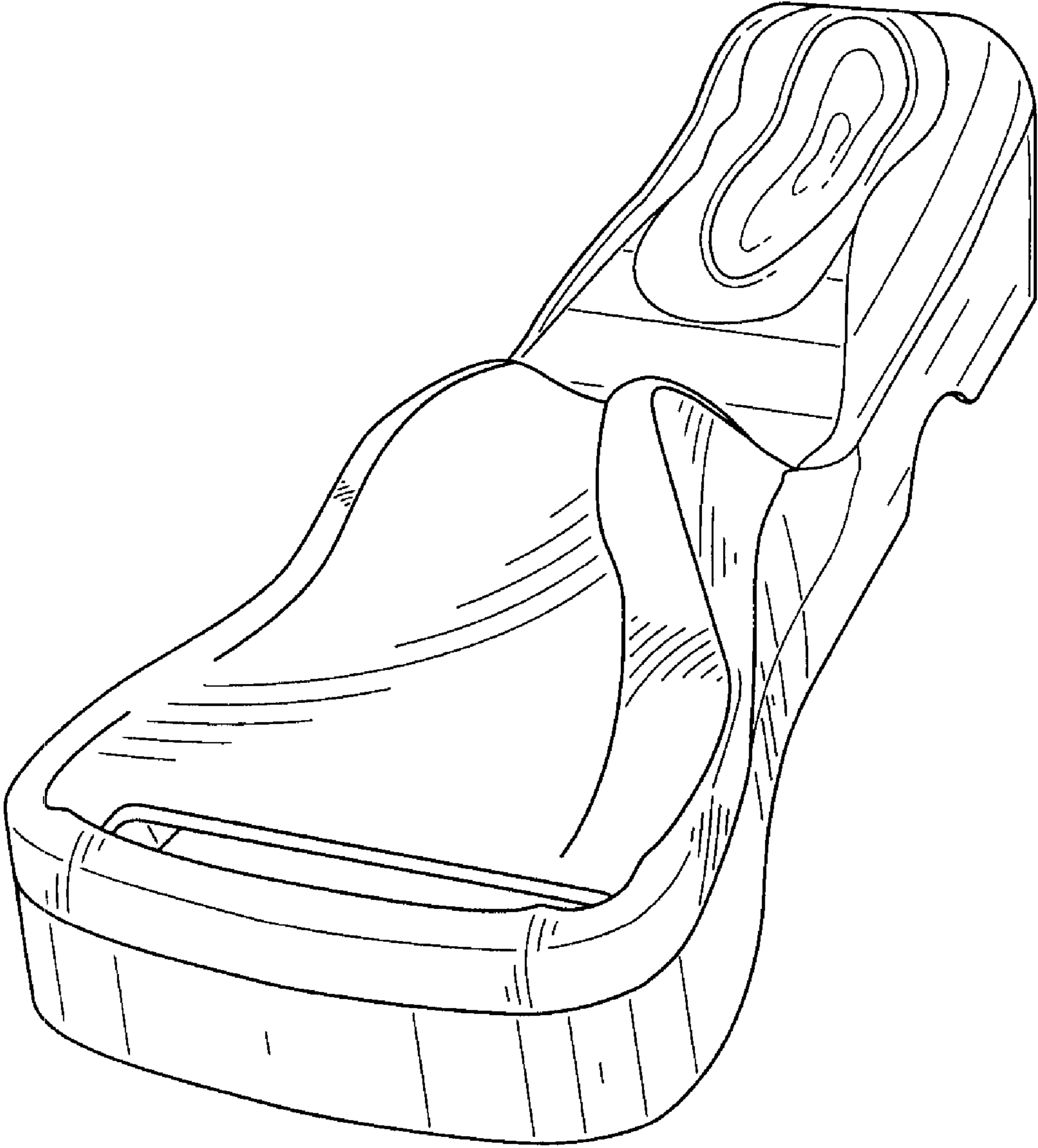

FIG. 1

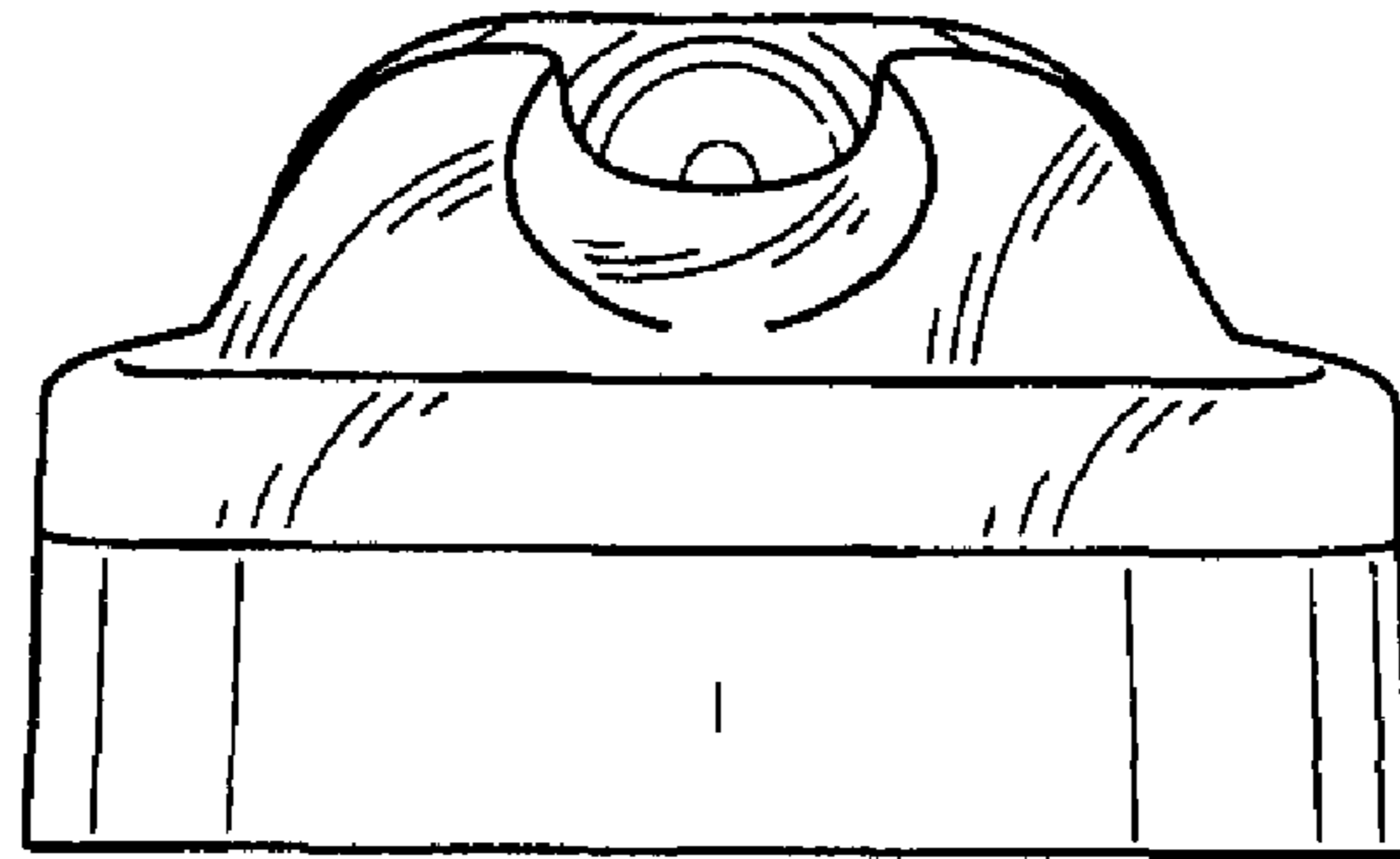

FIG. 2

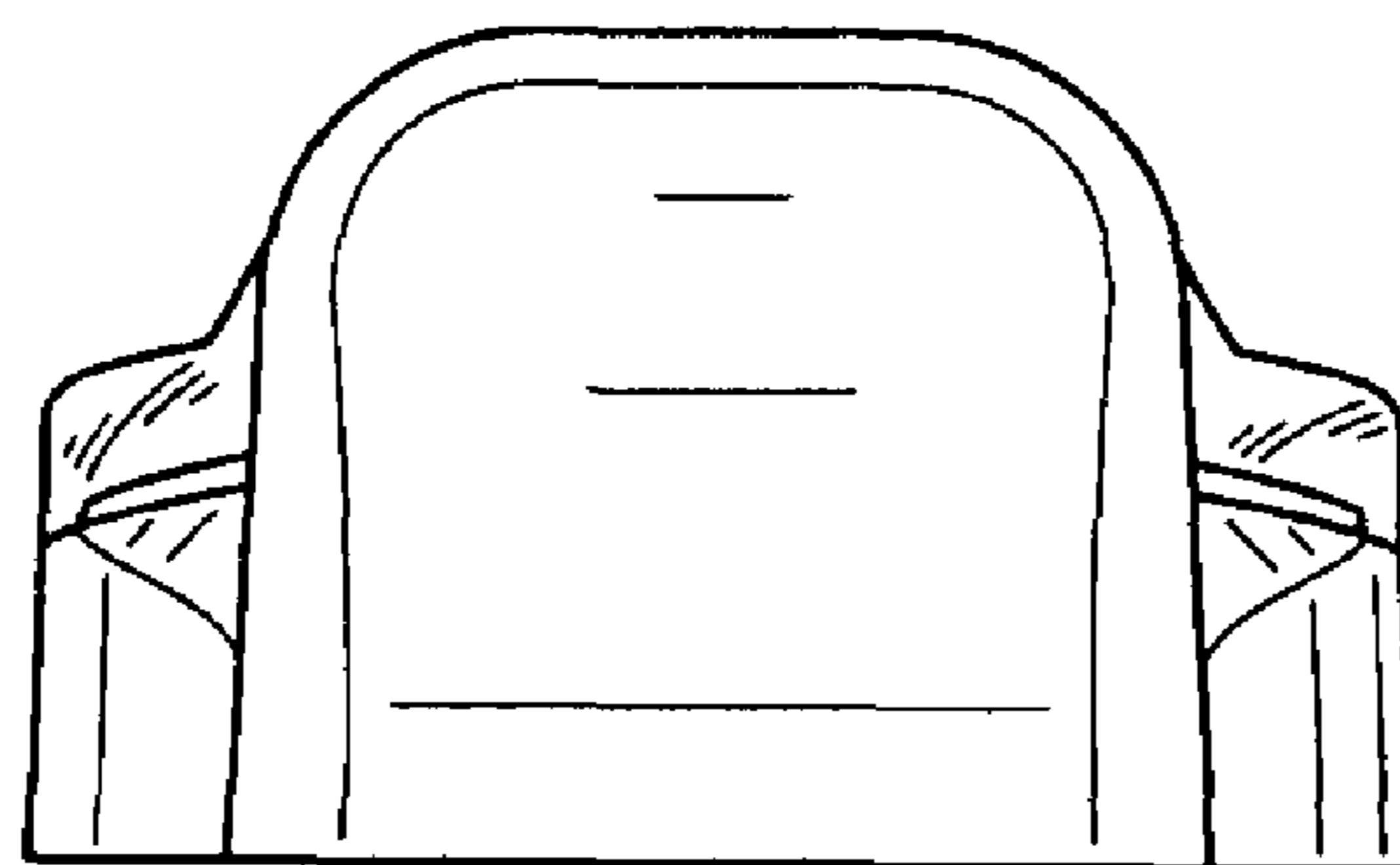

FIG. 3

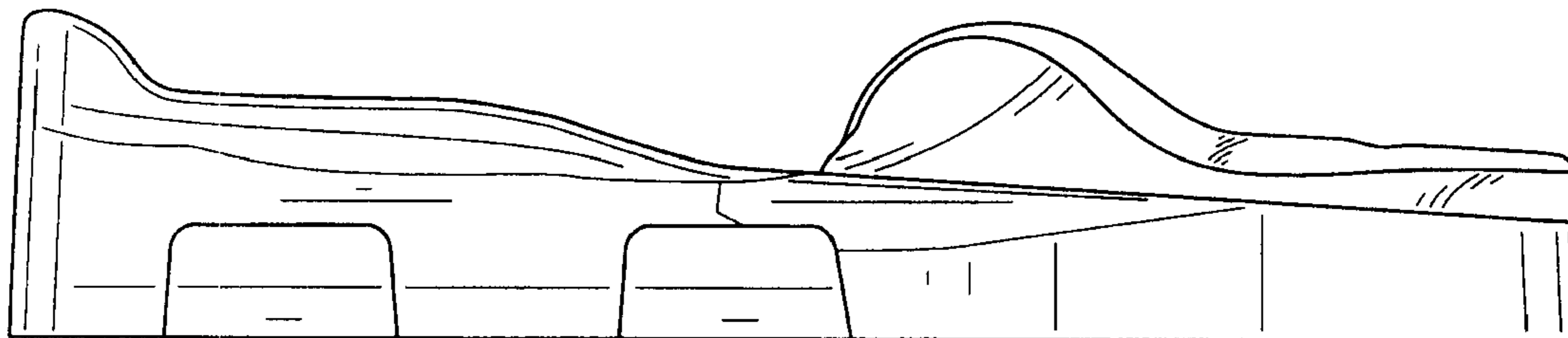

FIG. 4

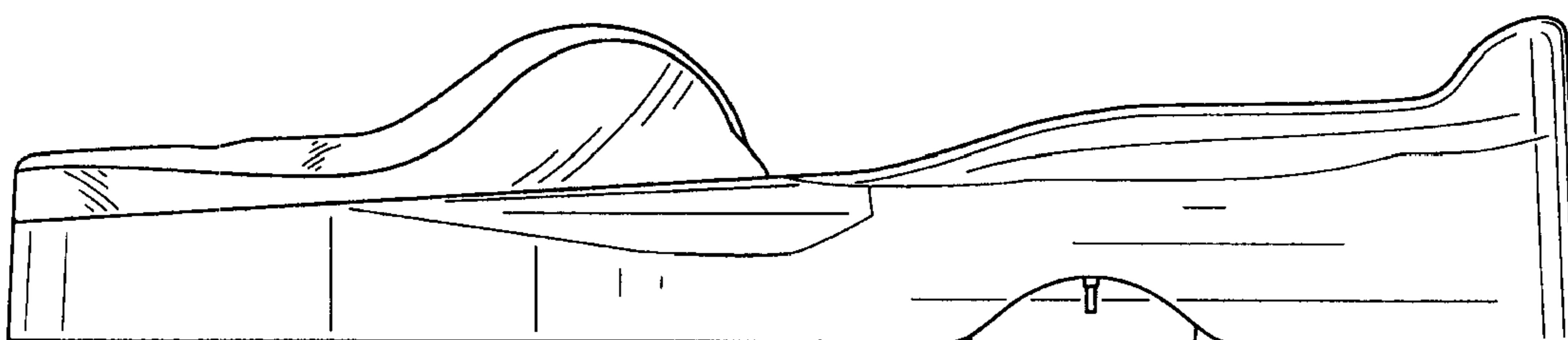

FIG. 5

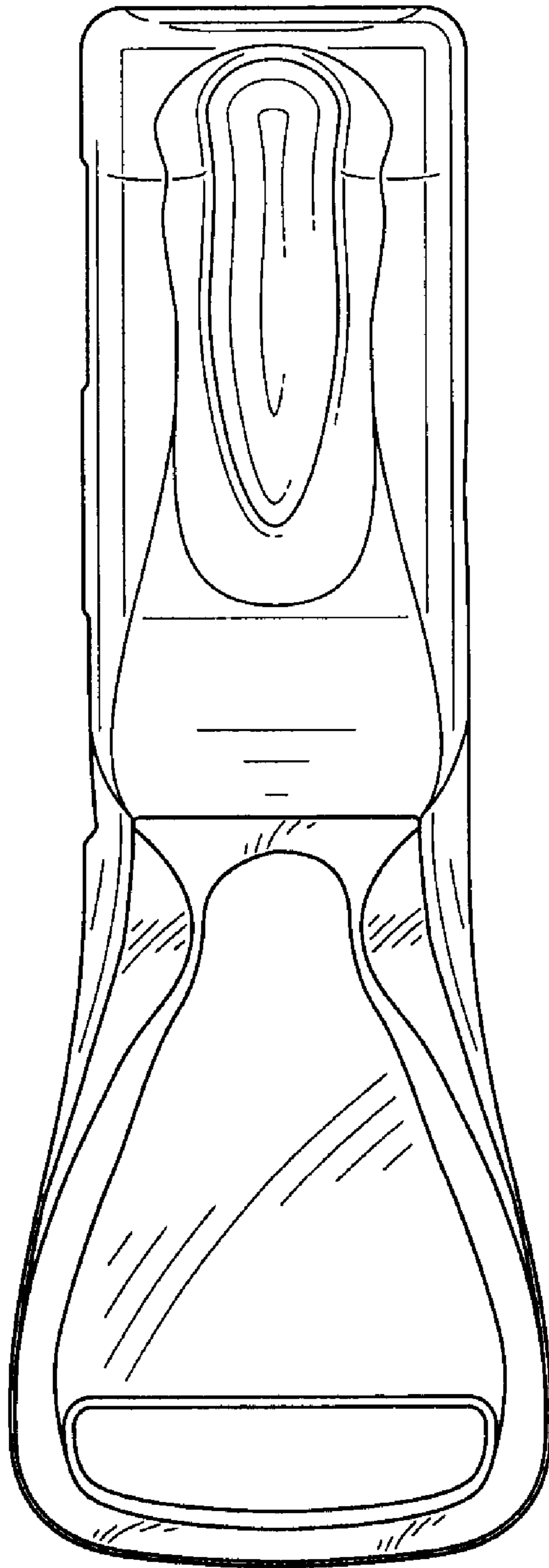

FIG. 6

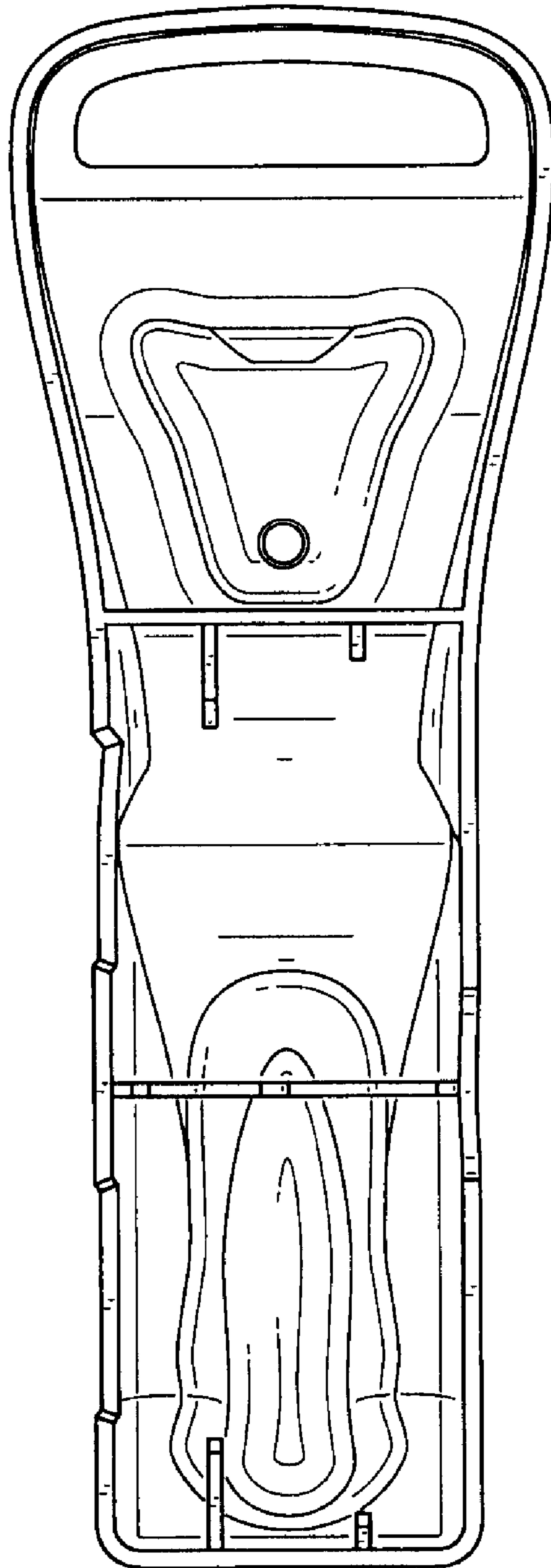

FIG. 7

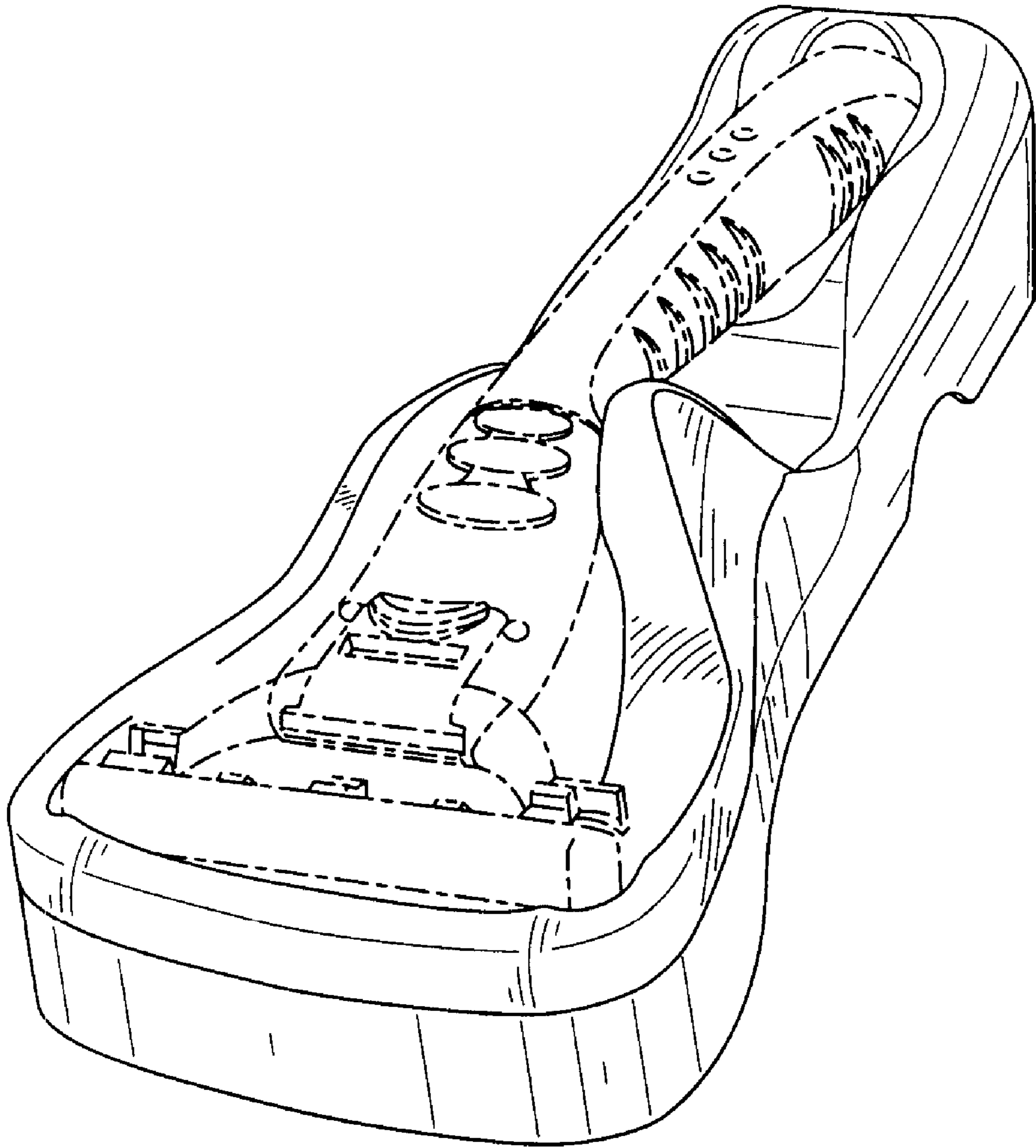

FIG. 8