



US00D533445S

(12) **United States Design Patent** (10) **Patent No.:** **US D533,445 S**  
**Janzen** (45) **Date of Patent:** **\*\* Dec. 12, 2006**

(54) **PARTITION BRACKET** 5,106,046 A 4/1992 Rowles et al.  
5,131,616 A 7/1992 Biba  
(75) Inventor: **Henry Janzen**, Indianapolis, IN (US) 5,149,032 A 9/1992 Jones et al.  
5,237,767 A 8/1993 Kringel et al.  
(73) Assignee: **Deflecto Corporation**, Indianapolis, IN (US) D341,077 S \* 11/1993 Chan ..... D8/381  
5,368,267 A 11/1994 Howard  
5,529,273 A 6/1996 Benthin  
(\*\*) Term: **14 Years** 6,363,663 B1 \* 4/2002 Kane et al. .... 52/36.6

FOREIGN PATENT DOCUMENTS

DE 40 02691 A1 1/1992  
EP 0525907 A2 2/1992

\* cited by examiner

*Primary Examiner*—Holly H. Baynham  
(74) *Attorney, Agent, or Firm*—Sonnenschein Nath & Rosenthal LLP; Brian R. McGinley

(21) Appl. No.: **29/222,076**  
(22) Filed: **Jan. 25, 2005**  
(51) **LOC (8) Cl.** ..... **08-05**  
(52) **U.S. Cl.** ..... **D8/380**  
(58) **Field of Classification Search** ..... D8/349,  
D8/354, 380; 248/300, 200; 52/239  
See application file for complete search history.

(57) **CLAIM**

The ornamental design for a partition bracket, as shown and described.

(56) **References Cited**  
U.S. PATENT DOCUMENTS

450,817 A 4/1891 Peevers  
756,024 A 3/1904 Jones  
1,236,269 A 8/1917 Cole  
1,411,572 A 4/1922 Kramer  
1,760,346 A 5/1930 Correa  
2,371,903 A 3/1945 Maier  
2,665,100 A 1/1954 Jason  
2,862,435 A 12/1958 Bucheberger  
2,867,401 A 1/1959 Sheahan  
2,955,794 A 10/1960 Robbins  
3,030,060 A 4/1962 Breuer  
3,204,902 A 9/1965 David  
3,567,261 A 3/1971 Akczinski  
3,664,626 A 5/1972 Sneller  
3,765,633 A 10/1973 Caudili  
3,841,609 A 10/1974 Smith  
3,939,986 A 2/1976 Pierro  
4,138,019 A 2/1979 Smith  
4,141,524 A 2/1979 Corvese, Jr.  
4,301,767 A 11/1981 Willinger et al.  
4,491,902 A 1/1985 Cangelosi  
4,727,890 A 3/1988 Vincent  
5,039,181 A 8/1991 Lautenschlager  
5,044,589 A 9/1991 Milne et al.

**DESCRIPTION**

FIG. 1 is a perspective view of a partition bracket showings in the new design;  
FIG. 2 is a front elevational view of the partition bracket shown in FIG. 1;  
FIG. 3 is a left, side elevational view of the partition bracket shown in FIG. 1 (the right, side elevational view of the partition bracket is a mirror image of the view shown in FIG. 3);  
FIG. 4 is a rear elevational view of the partition bracket shown in FIG. 1;  
FIG. 5 is a top view of the partition bracket shown in FIG. 1;  
FIG. 6 is a bottom view of the partition bracket shown in FIG. 1; and,  
FIG. 7 is a perspective view of the partition bracket shown in FIG. 1 with the broken lines showing a partial partition being for illustrative purposes only and forming no part of the claimed design.

**1 Claim, 5 Drawing Sheets**

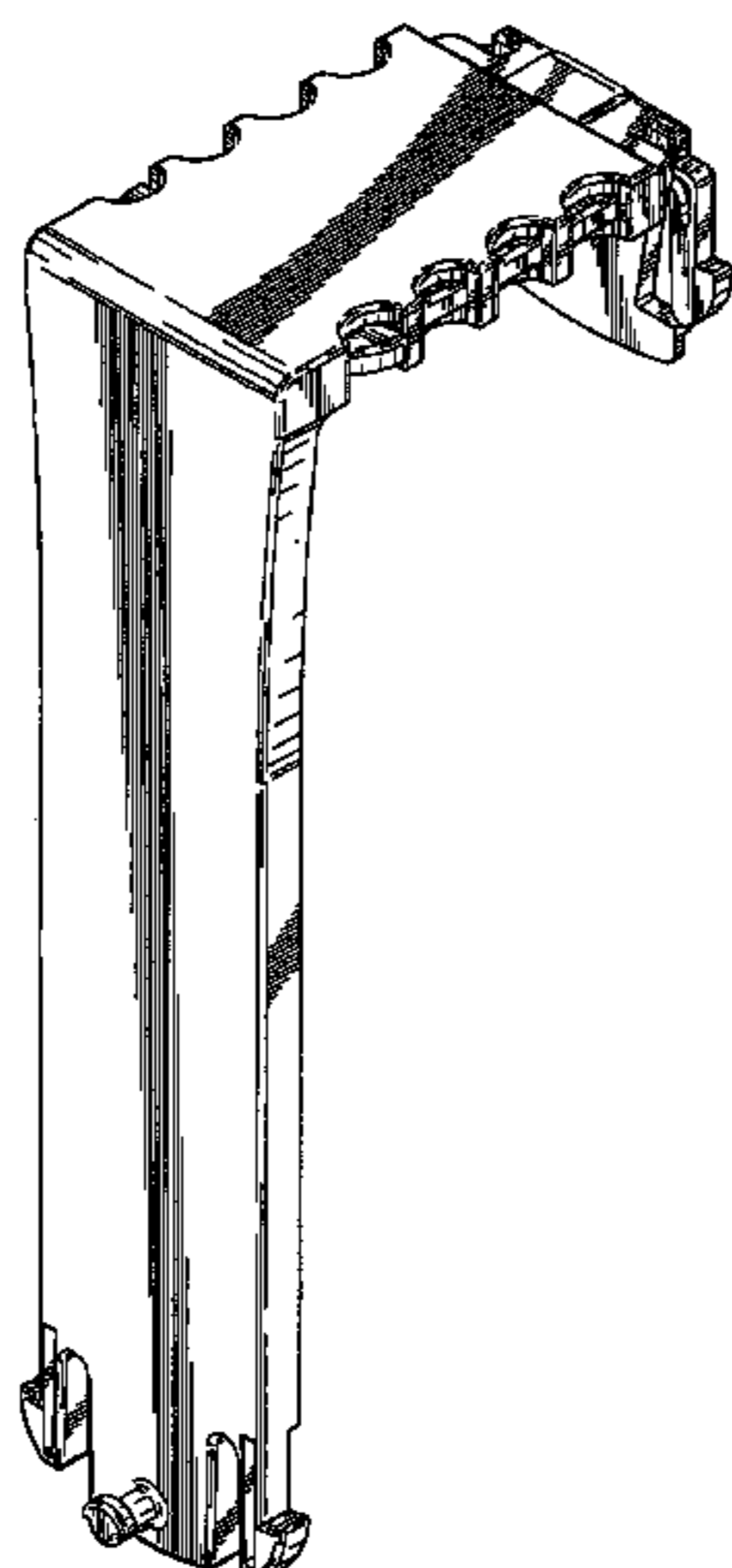

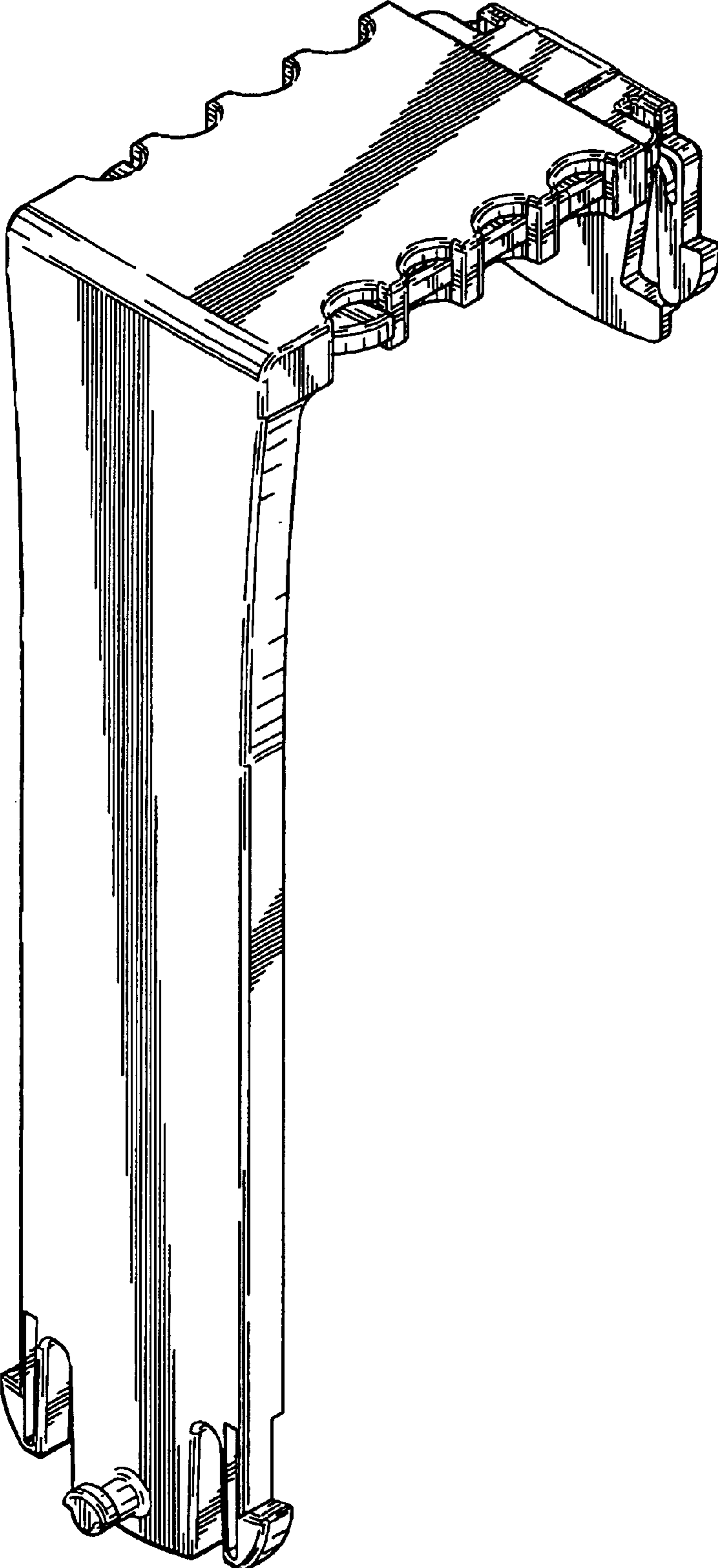

FIG. 1

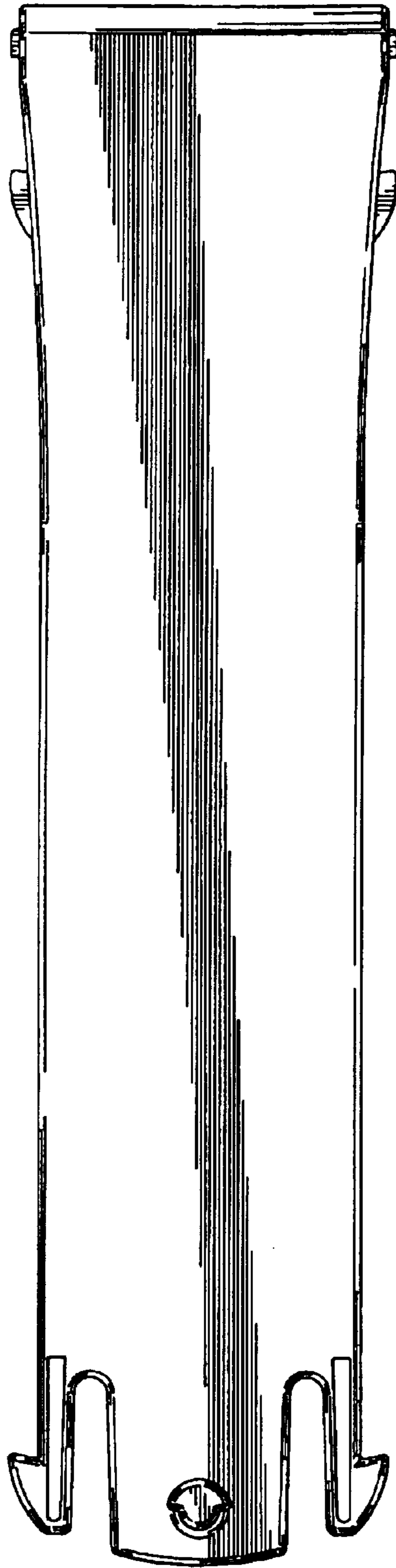

FIG. 2

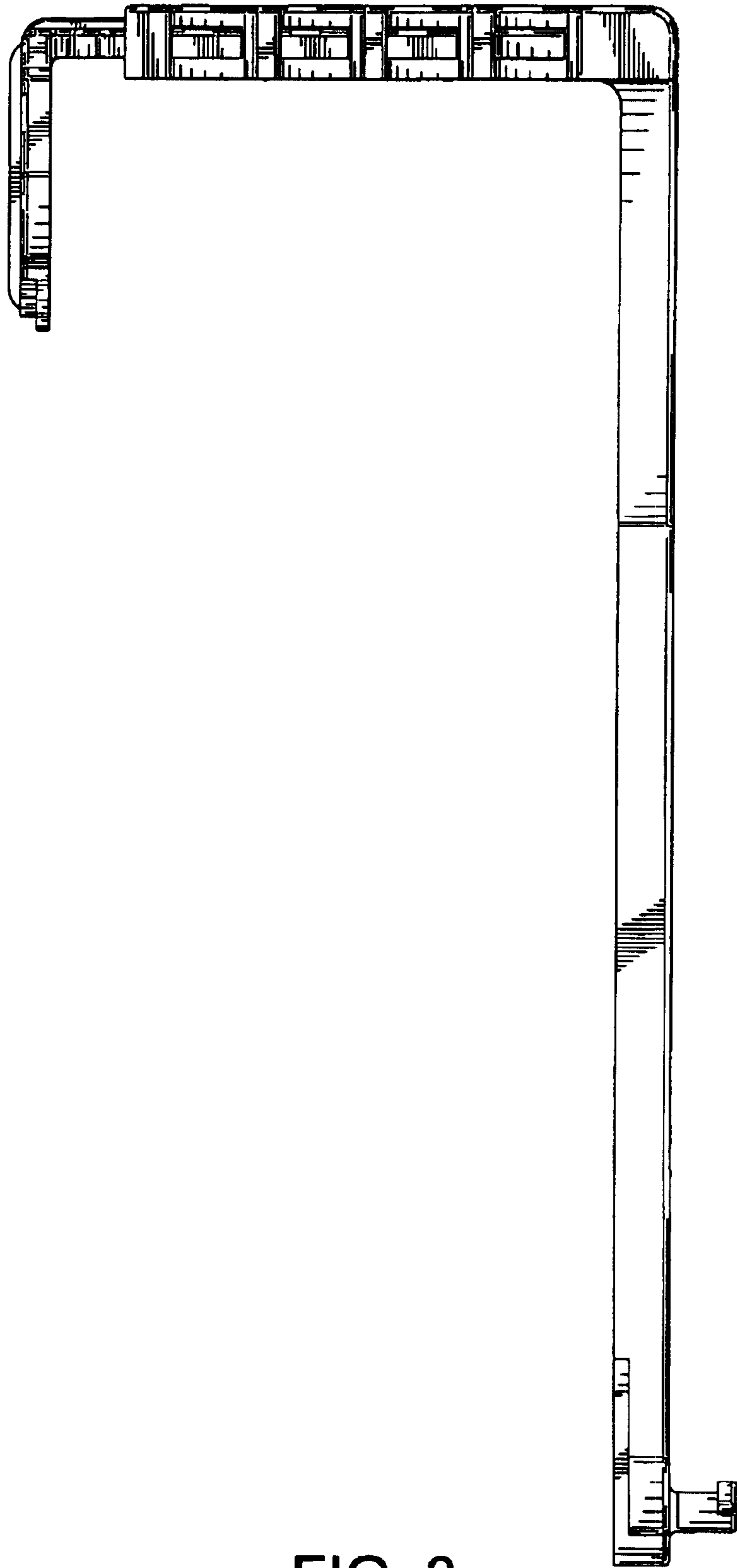

FIG. 3

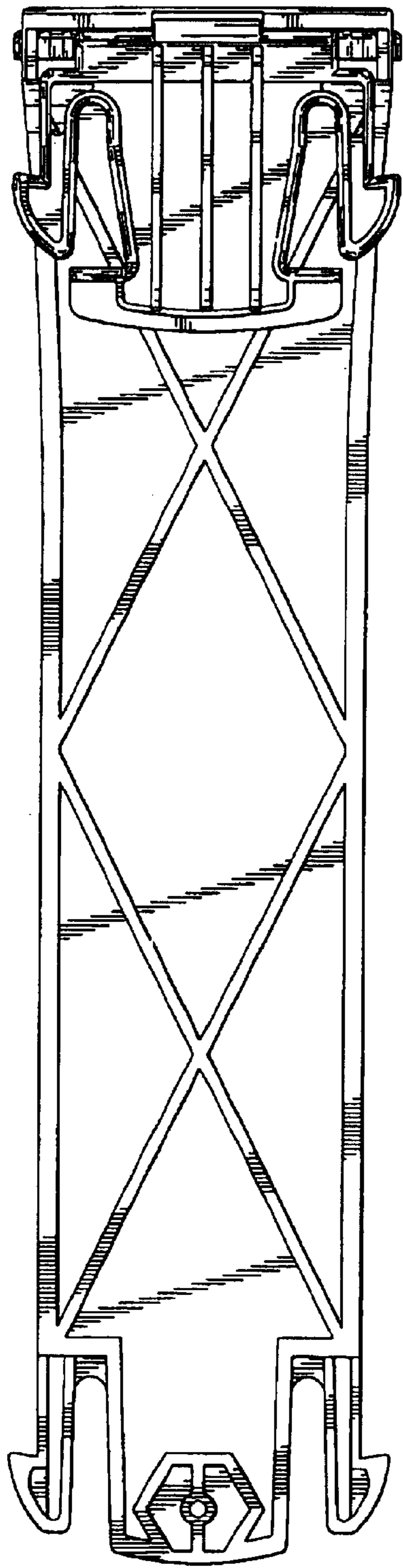

FIG. 4

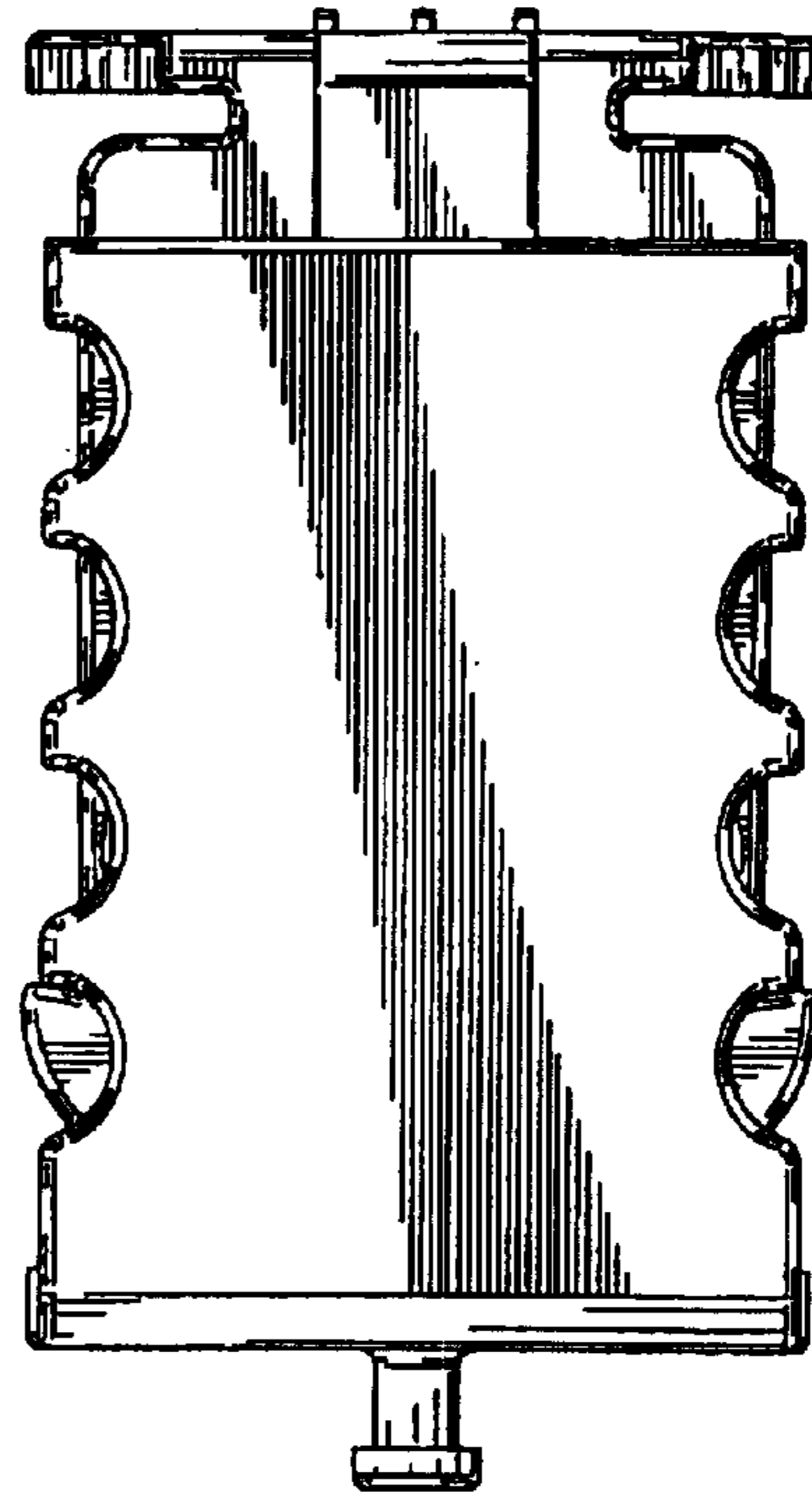

FIG. 5

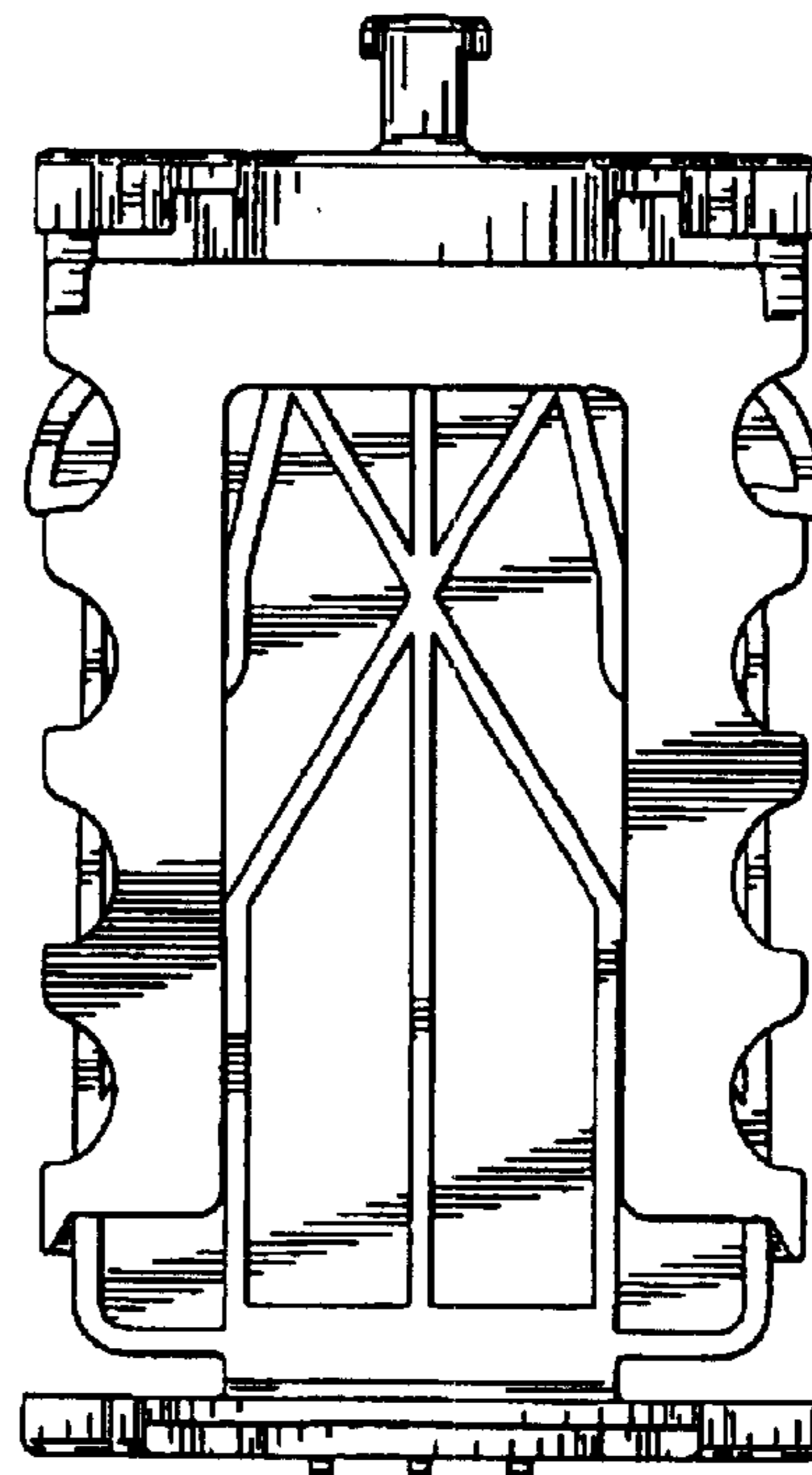

FIG. 6

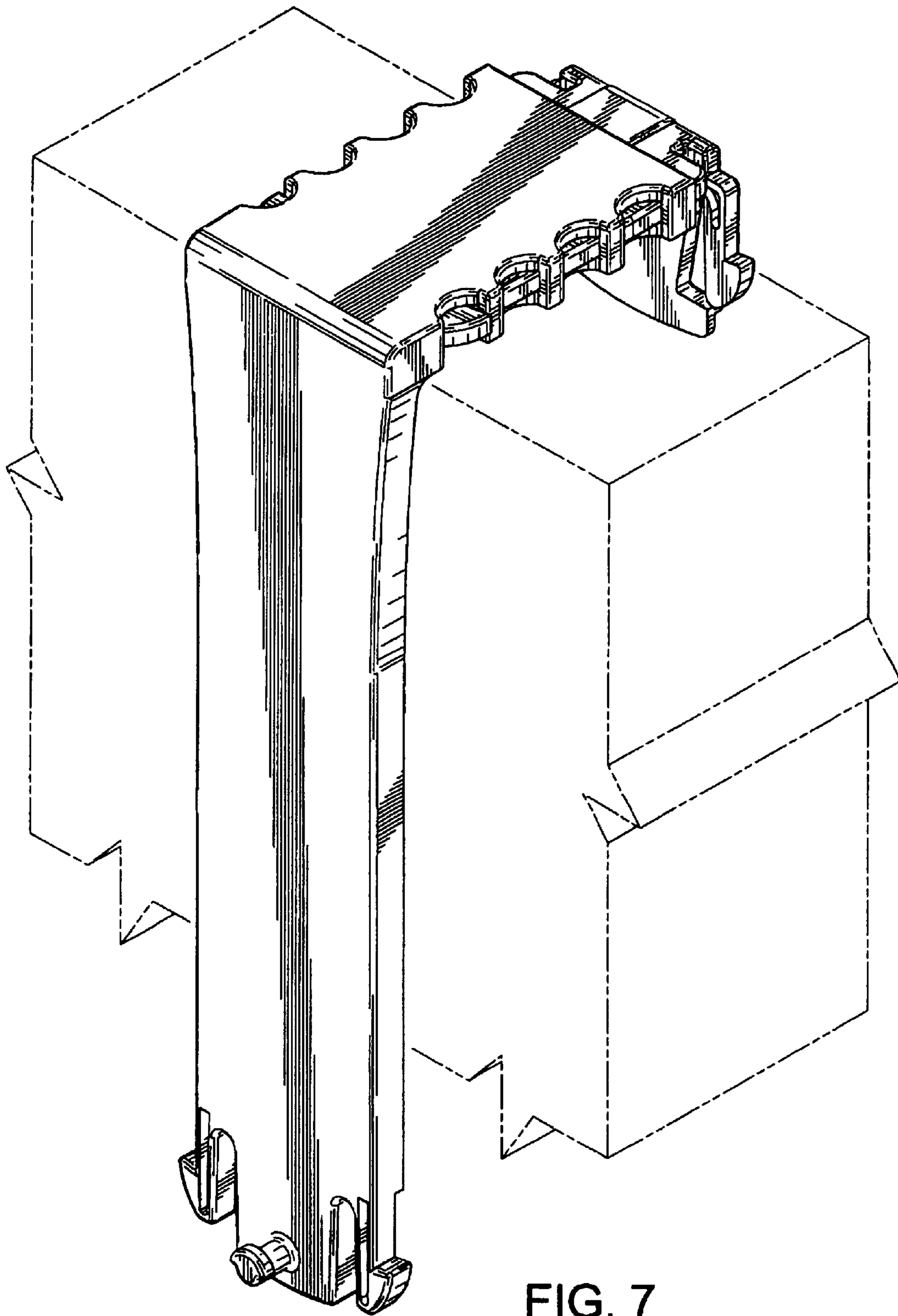

FIG. 7