



US00D533380S

(12) **United States Design Patent**
Dansreau et al.

(10) **Patent No.:** **US D533,380 S**

(45) **Date of Patent:** **** Dec. 12, 2006**

(54) **RAZOR CADDY**

D423,845 S * 5/2000 Coffin et al. D6/526
D464,222 S * 10/2002 Coffin et al. D6/526

(75) Inventors: **Paul R. Dansreau**, Shelton, CT (US);
David C. Coffin, Hamden, CT (US);
David Dombrowski, Madison, CT (US)

* cited by examiner

Primary Examiner—Brian N Vinson

(73) Assignee: **Eveready Battery Company, Inc.**, St.
Louis, MO (US)

(74) *Attorney, Agent, or Firm*—Michaud-Duffy Group LLP

(**) **Term:** **14 Years**

(57) **CLAIM**

We claim the new, original and ornamental design for a razor caddy, as shown and described.

(21) Appl. No.: **29/201,721**

DESCRIPTION

(22) Filed: **Mar. 19, 2004**

This application is entitled to the benefit of and incorporates by reference essential subject matter disclosed in Design patent application Ser. No. 29/178,709 filed on Mar. 28, 2003.

(51) **LOC (8) Cl.** **28-03**

(52) **U.S. Cl.** **D6/526**

(58) **Field of Classification Search** D6/526;

206/349, 351-360, 208-210; 211/13.1, 70.6,

211/86.01, 87.01, 88.01; 248/309.1

See application file for complete search history.

FIG. 1 is a front perspective view of the razor caddy,

FIG. 2 is a rear perspective view of the razor caddy,

FIG. 3 is a right hand side view of the razor caddy,

FIG. 4 is a front view of the razor caddy,

FIG. 5 is a left hand side view of the razor caddy,

FIG. 6 is a rear view of the razor caddy,

FIG. 7 is a top view of the razor caddy; and,

FIG. 8 is a bottom view of the razor caddy.

The broken-line disclosure in the views is for illustrative purposes only and is understood to form no part of the claimed design.

(56) **References Cited**

U.S. PATENT DOCUMENTS

3,945,499 A * 3/1976 Brownson 211/88.01

D335,599 S * 5/1993 Novak D6/526

5,228,580 A * 7/1993 Grange 211/70.6

D342,853 S * 1/1994 Grange D6/526

D364,060 S * 11/1995 Lai D6/526

D370,375 S * 6/1996 Murgida et al. D6/526

1 Claim, 3 Drawing Sheets

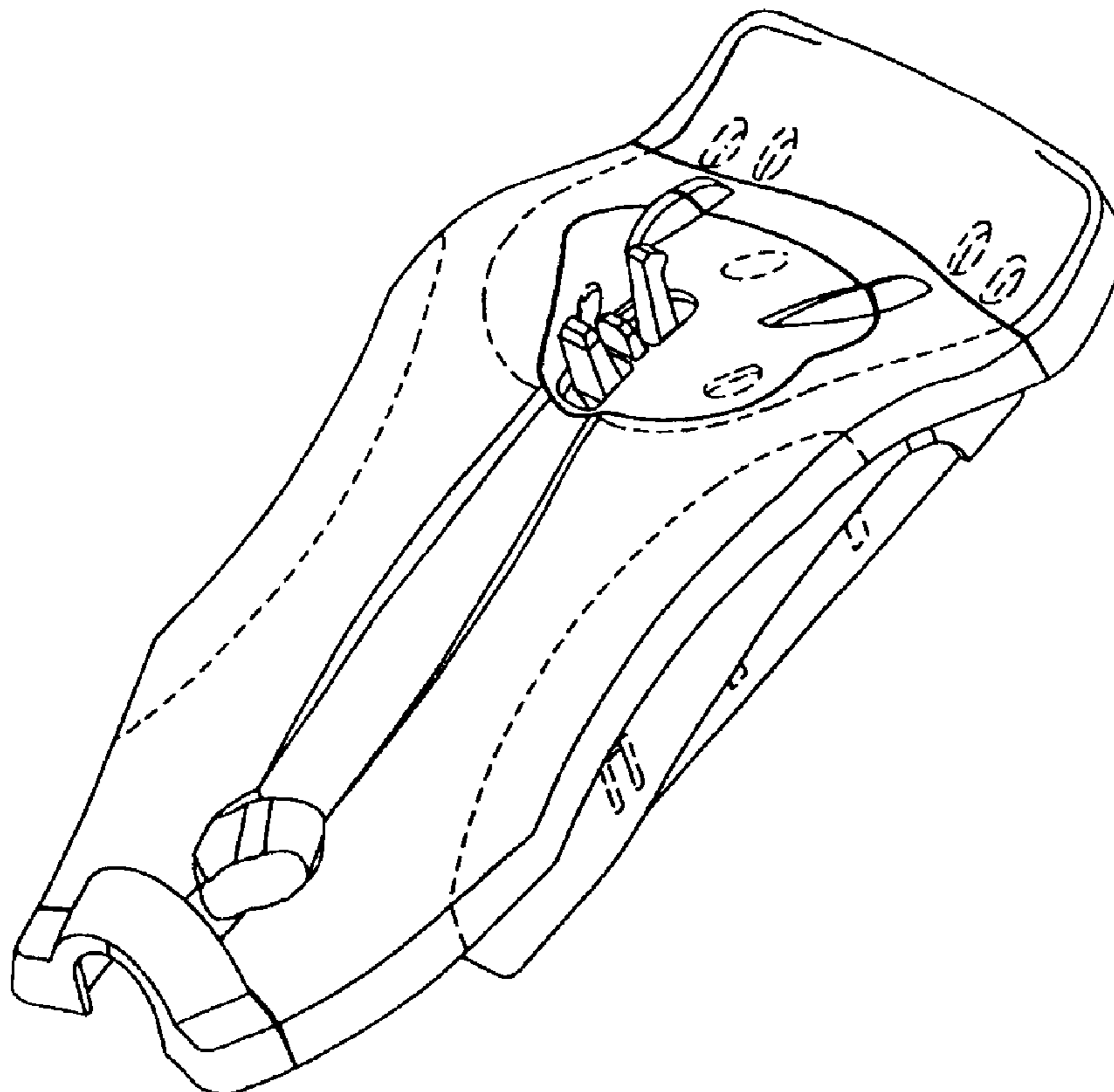

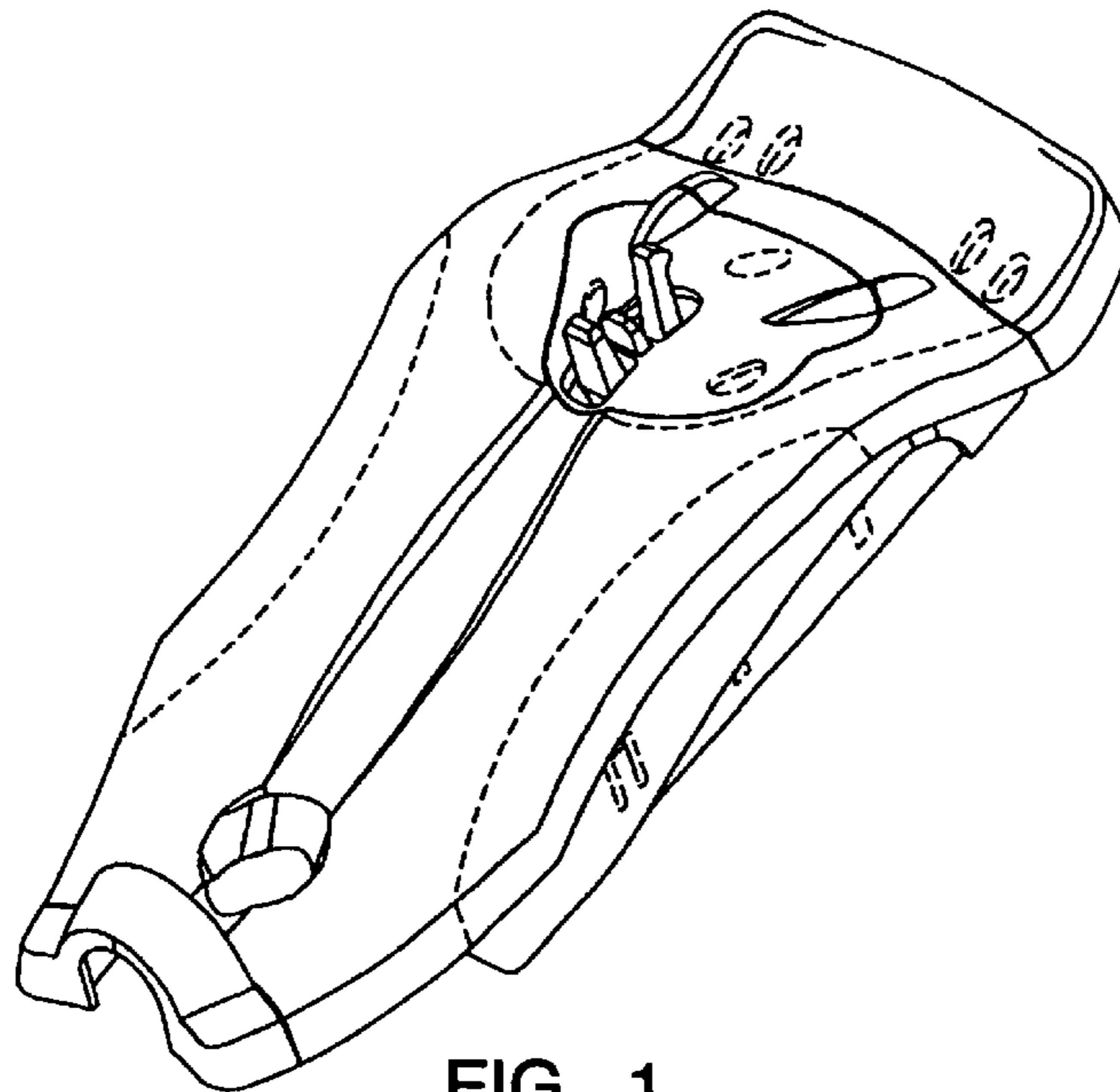

FIG. 1

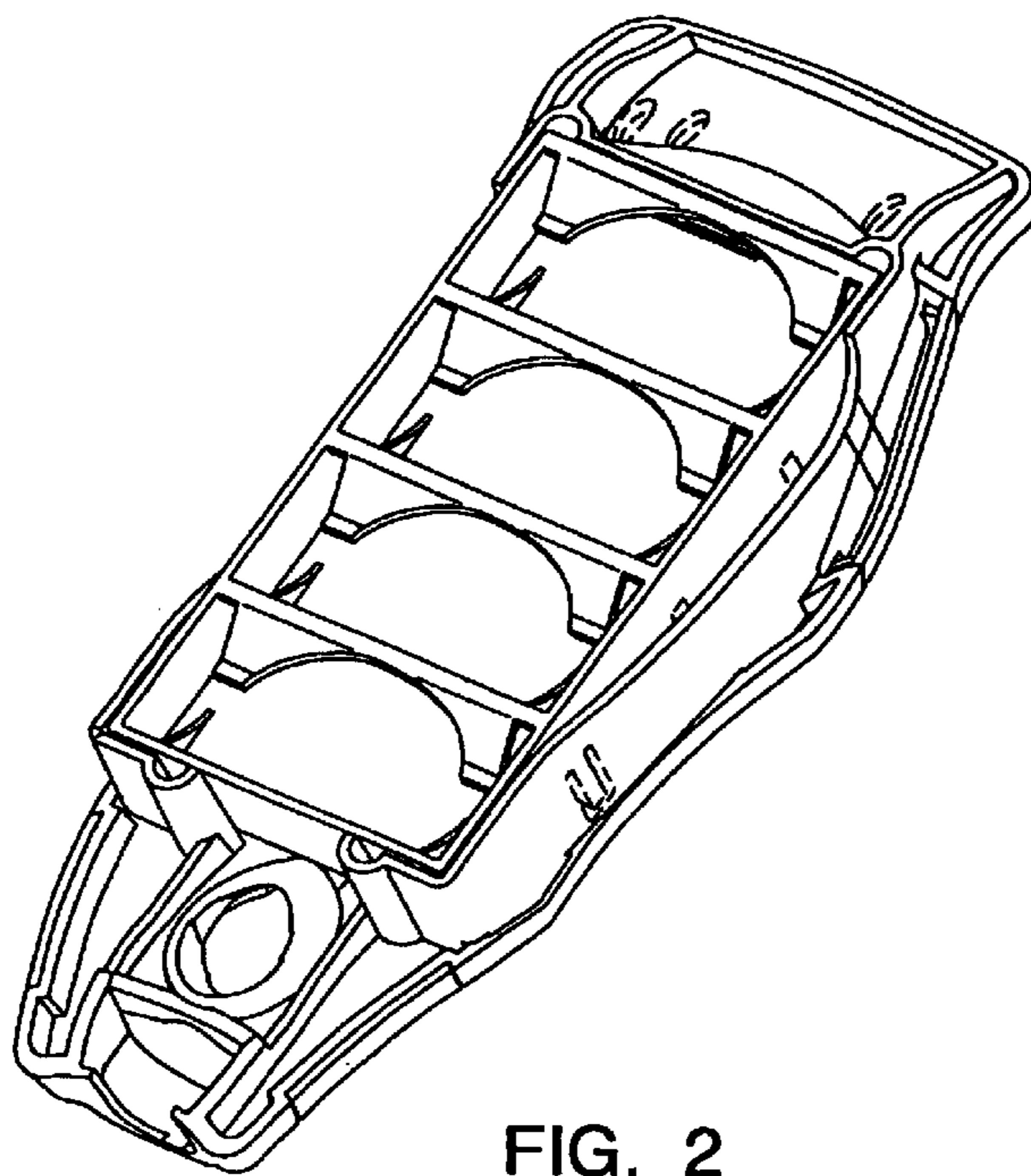

FIG. 2

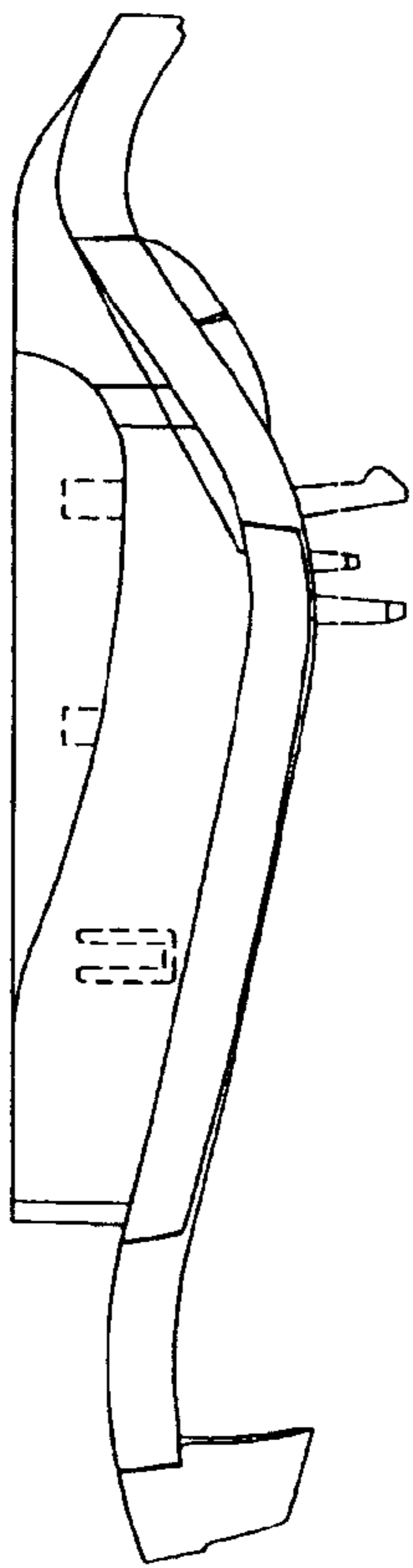

FIG. 3

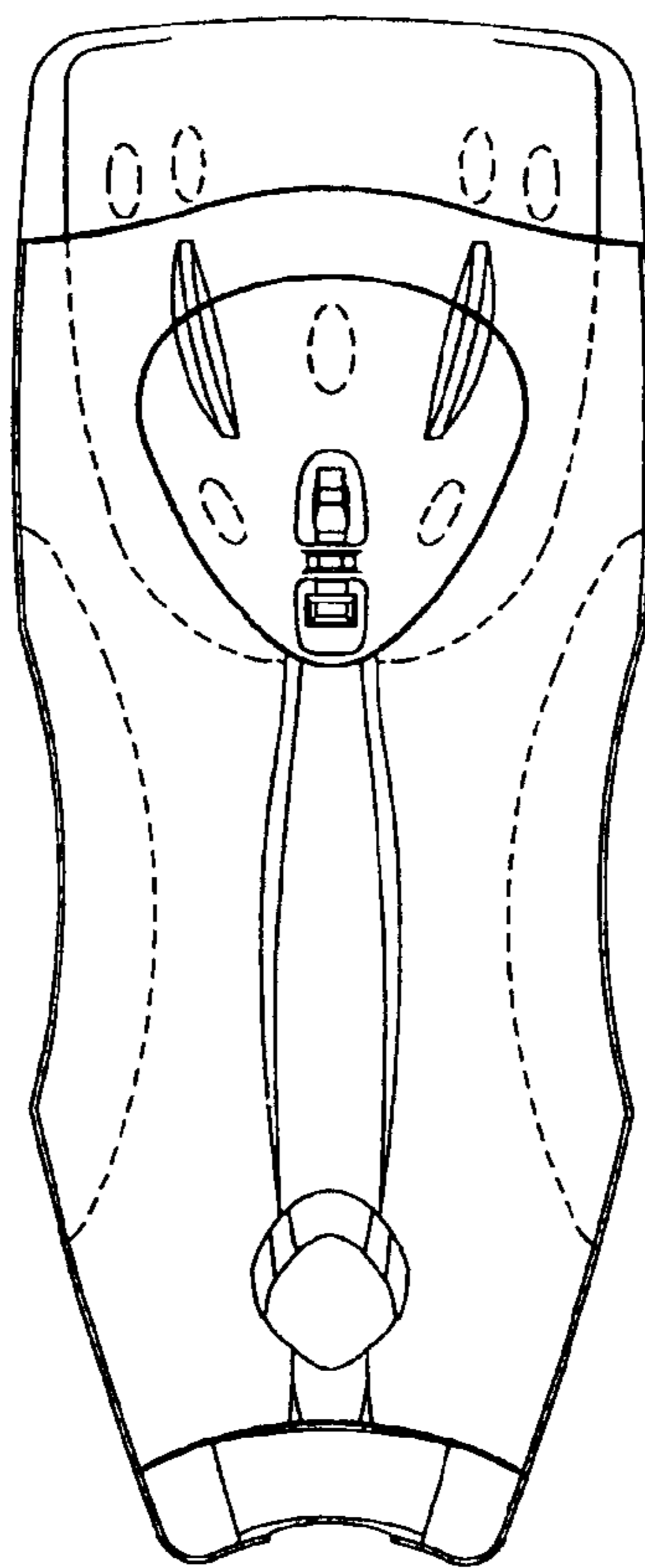

FIG. 4

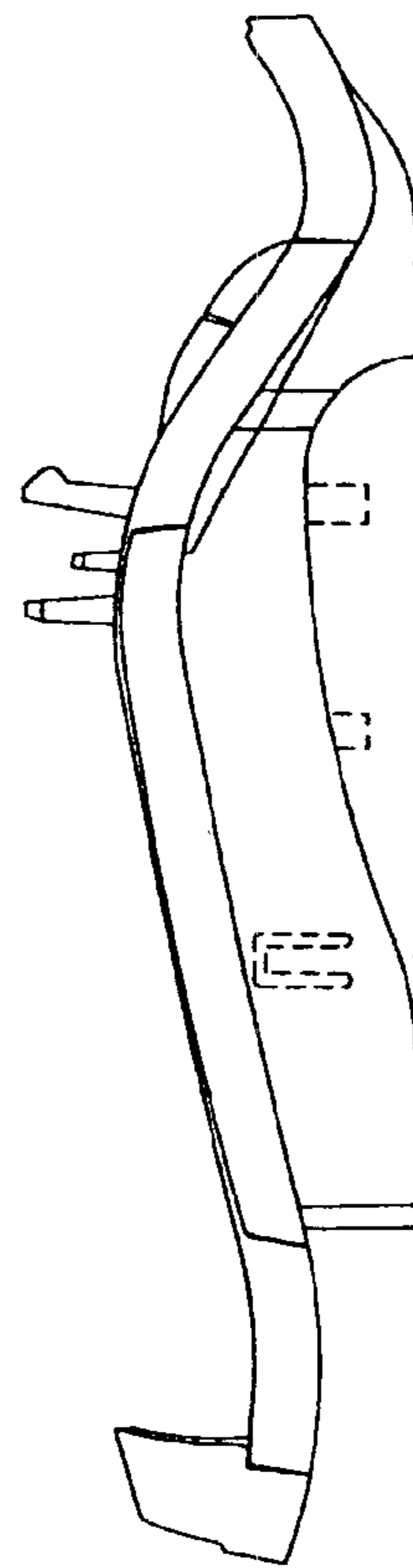

FIG. 5

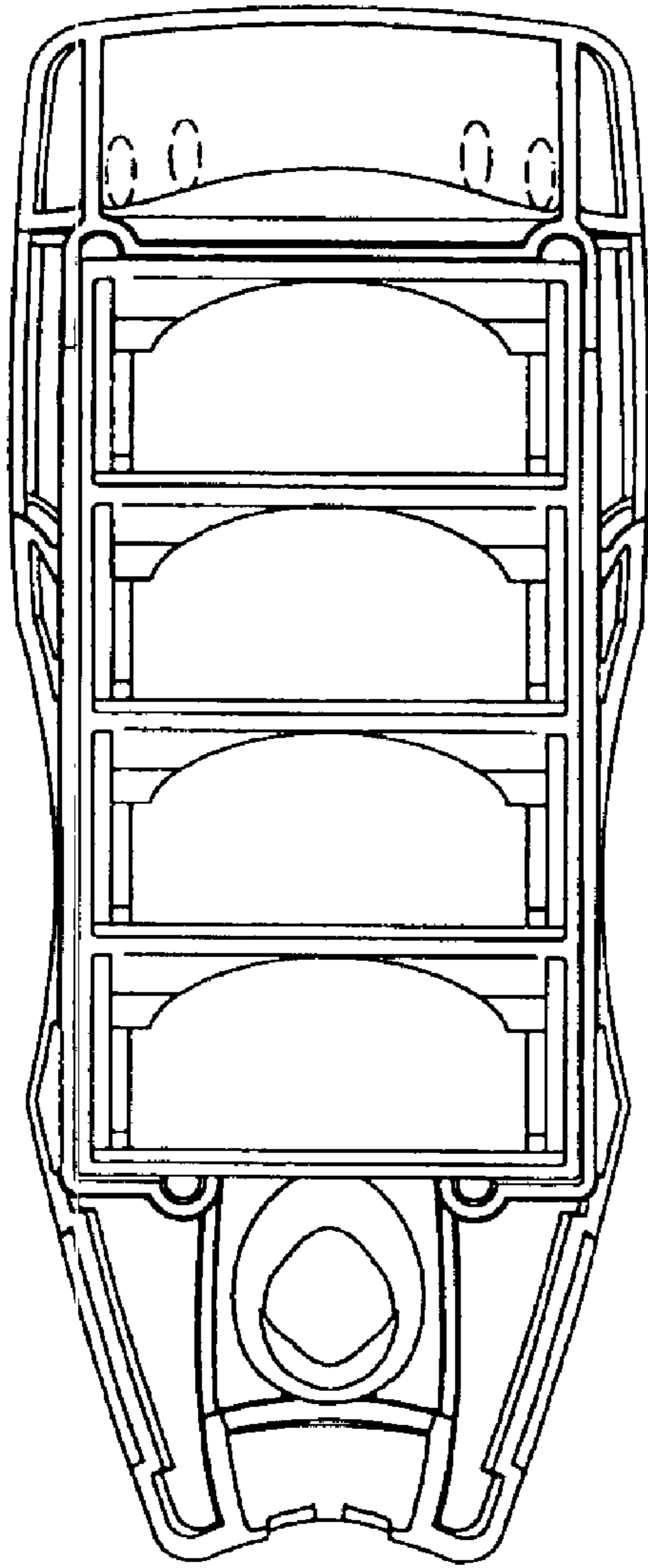

FIG. 6

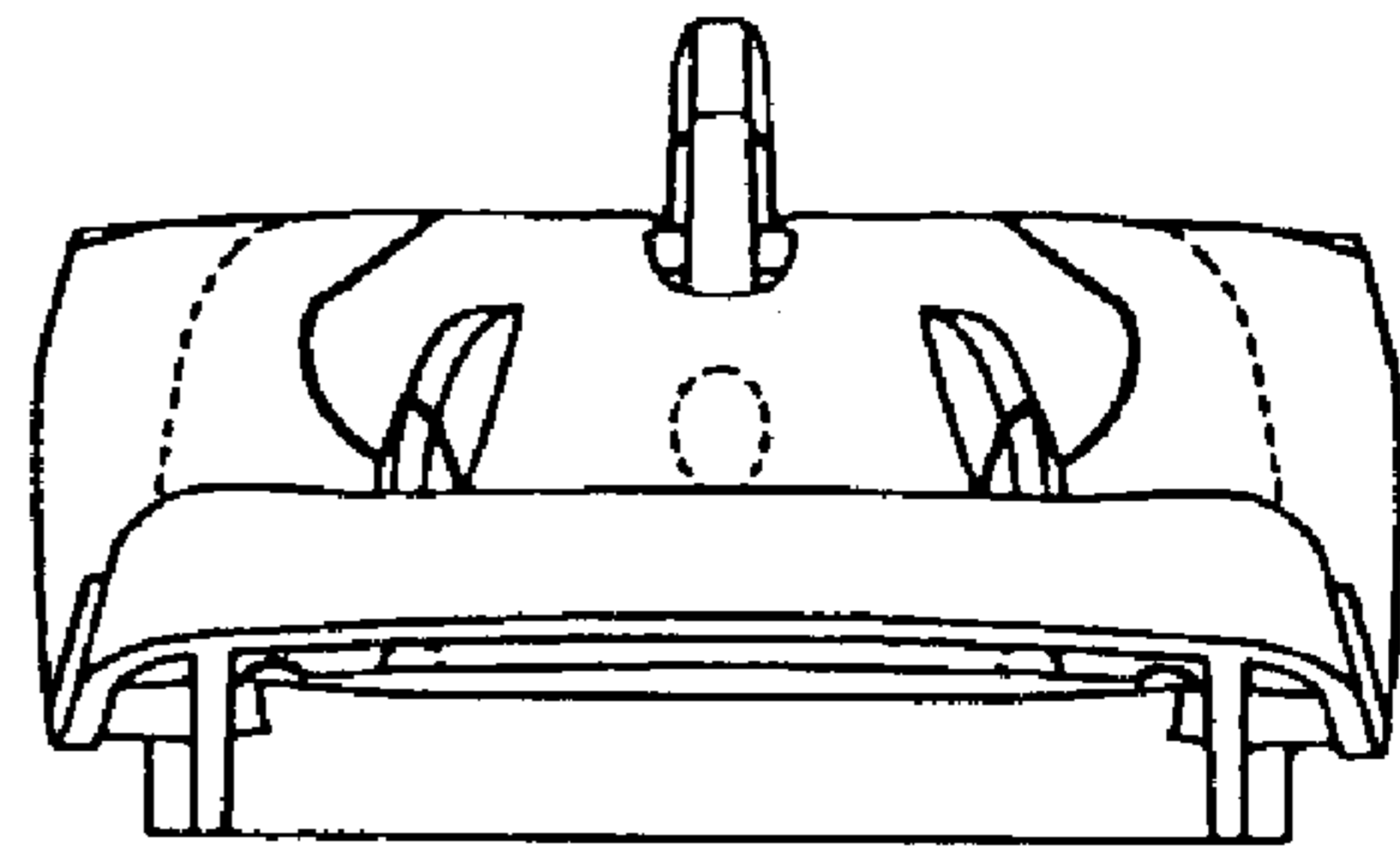

FIG. 7

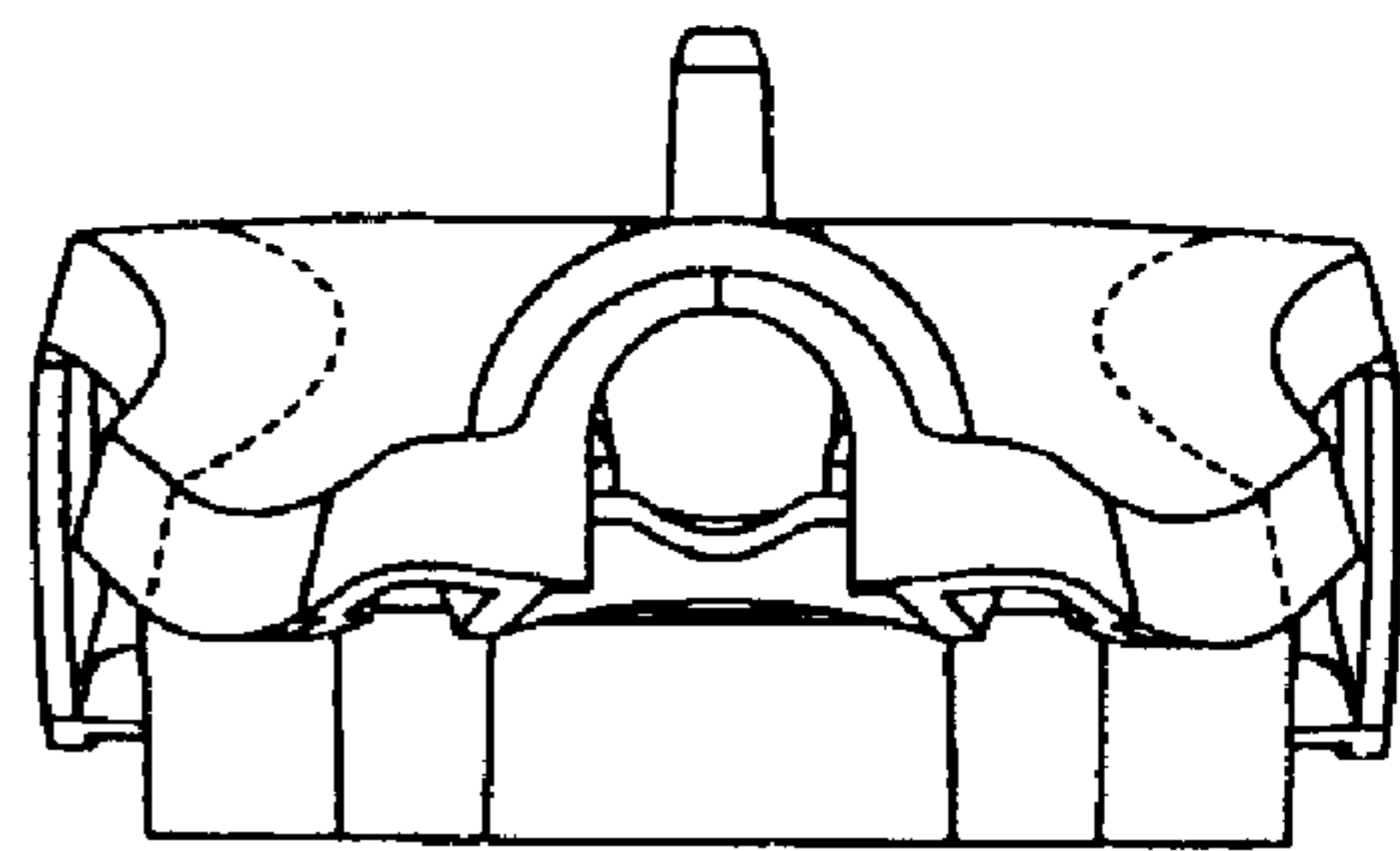

FIG. 8