



US00D533344S

(12) **United States Design Patent**
Lim

(10) **Patent No.:** **US D533,344 S**

(45) **Date of Patent:** **** Dec. 12, 2006**

(54) **HANDBAG WITH STRAP**

(75) **Inventor:** **Sharon Lim**, 553 Third Ave., #13, New York, NY (US) 10016

(73) **Assignees:** **Sharon Lim**, New York, NY (US); **Slim NYC Designs**, New York, NY (US)

(**) **Term:** **14 Years**

(21) **Appl. No.:** **29/231,175**

(22) **Filed:** **Jun. 3, 2005**

(51) **LOC (8) Cl.** **03-01**

(52) **U.S. Cl.** **D3/232**

(58) **Field of Classification Search** D3/231, D3/232, 233, 234, 237, 238, 240, 241, 242, D3/243, 245, 246, 303, 318, 321, 322, 323, D3/324, 325, 326, 902; 150/100, 106, 107, 150/110, 111, 112, 118, 900; 190/100, 109, 190/112, 115, 119, 121, 902, 903; 383/4, 383/6, 7, 8, 10, 12, 15, 22, 23, 25, 26, 27, 383/29, 31, 37, 38, 41, 42, 78, 84, 86, 104, 383/117

See application file for complete search history.

(56) **References Cited**

U.S. PATENT DOCUMENTS

1,564,967 A * 12/1925 Kulick 383/86

1,594,989 A * 8/1926 Auster et al. 383/86
2,064,333 A * 12/1936 Ashkenas 150/110
2,079,401 A * 5/1937 Eisenberg et al. 150/110
2,845,105 A * 7/1958 Neas 150/106
D323,744 S * 2/1992 Casale D3/243
D456,604 S * 5/2002 Plummer D3/233

* cited by examiner

Primary Examiner—Louis S. Zarfaz

Assistant Examiner—Monica A. Weingart

(74) *Attorney, Agent, or Firm*—Emily Danchuk, Esq.

(57) **CLAIM**

I claim the handbag with strap, as shown and described.

DESCRIPTION

FIG. 1 is a view of one side of the invention.

FIG. 2 is a view of the other side of the invention.

FIG. 3 is a top view of the invention.

FIG. 4 is a bottom view of the invention.

FIG. 5 is a front view of the invention.

FIG. 6 is a back view of the invention; and,

FIG. 7 is a partially open view of the invention.

The strap has been omitted in FIGS. 3 and 4 for ease of illustration.

1 Claim, 5 Drawing Sheets

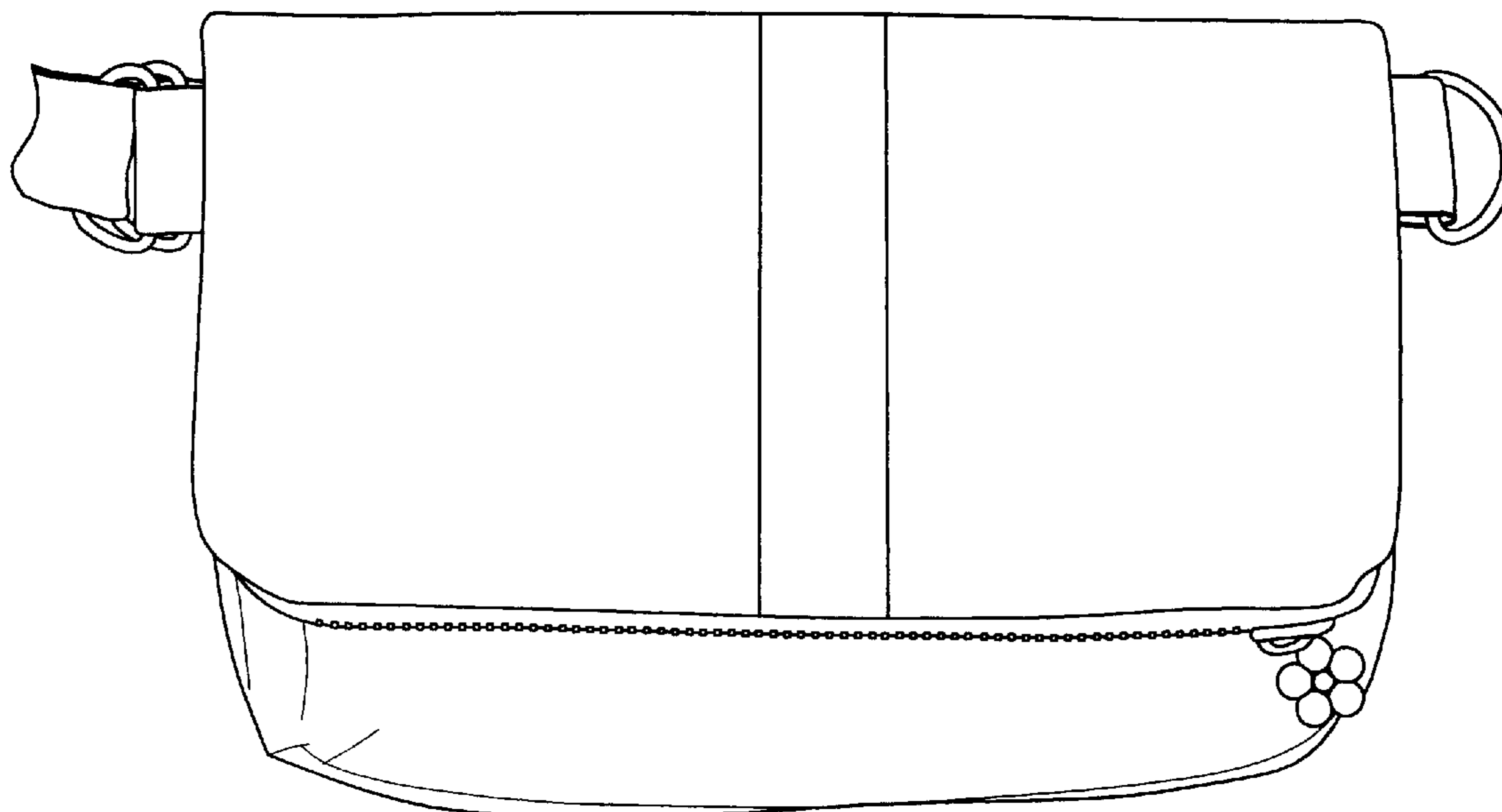

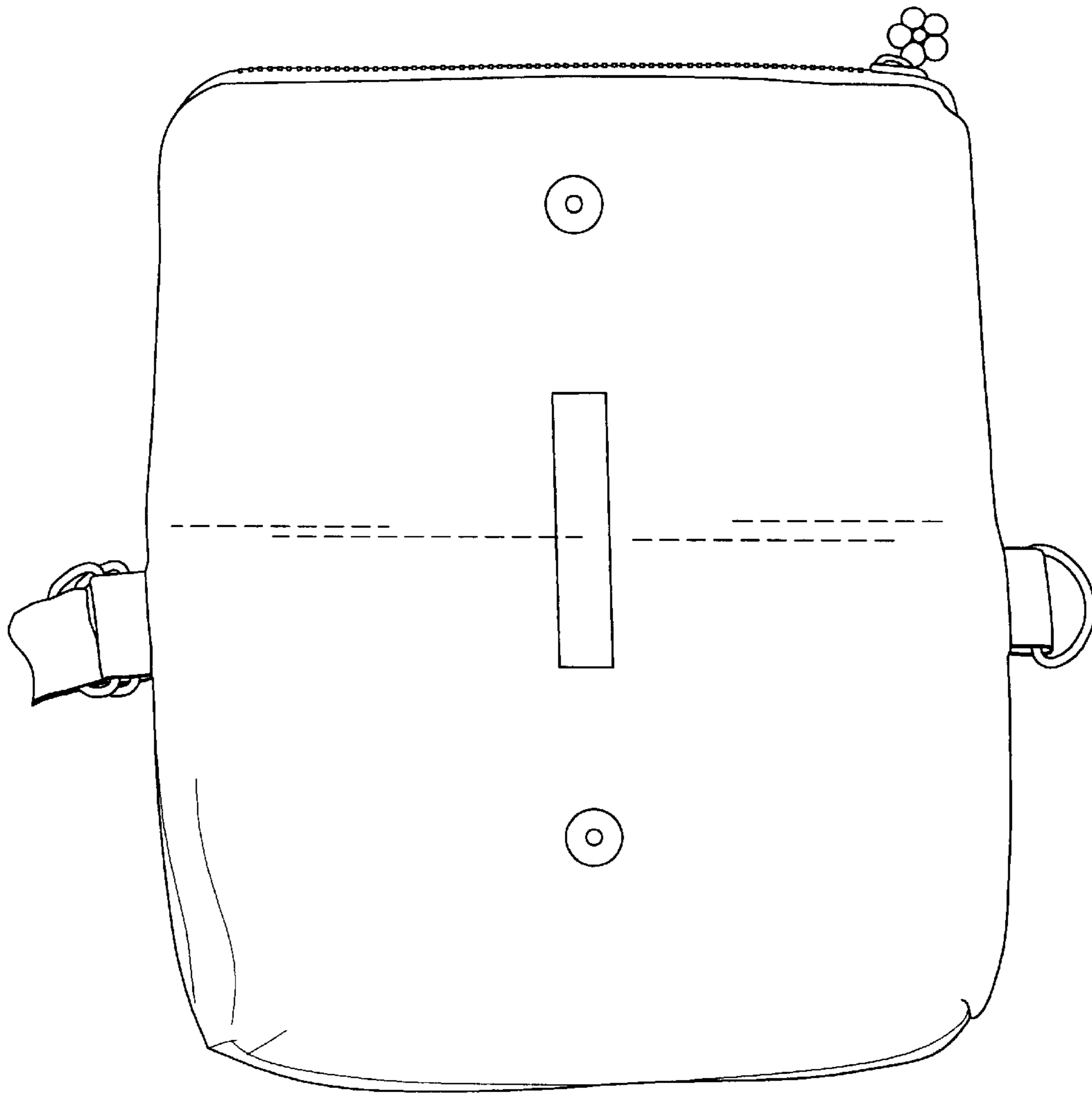

Fig. 1

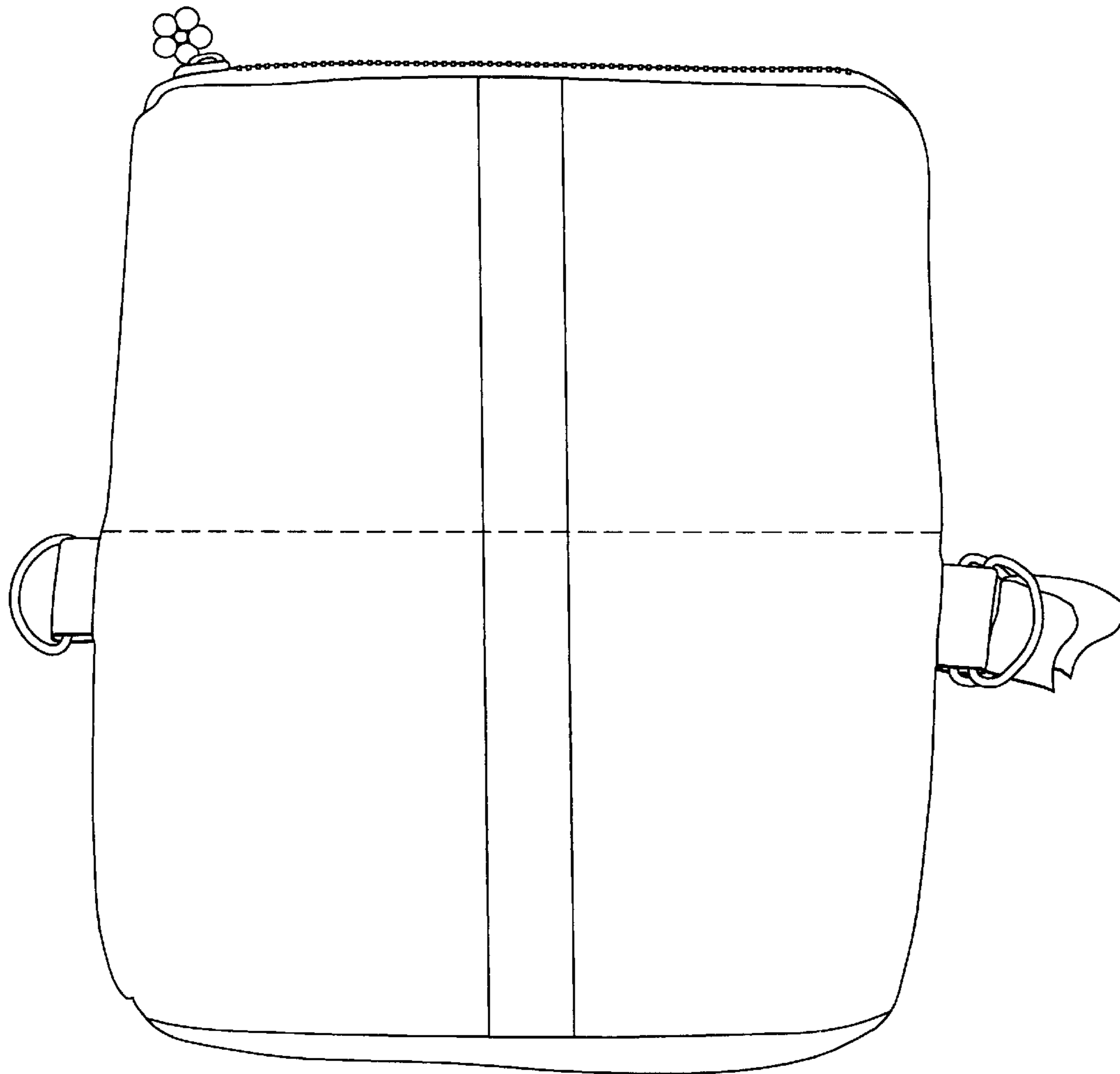

Fig. 2

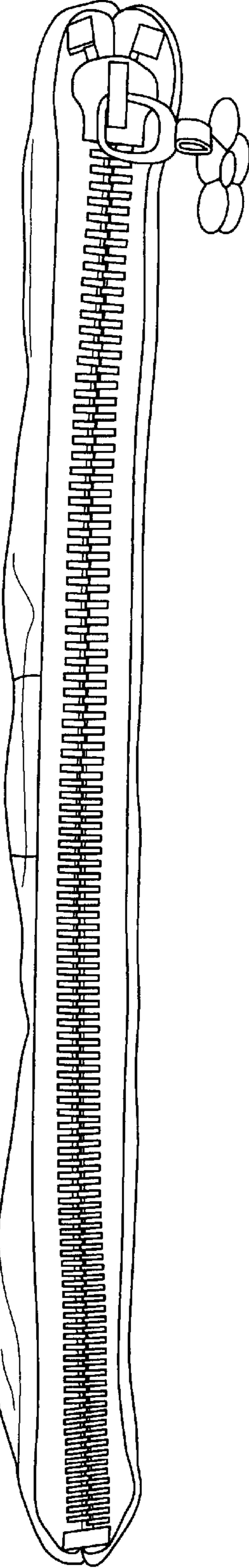

Fig. 3

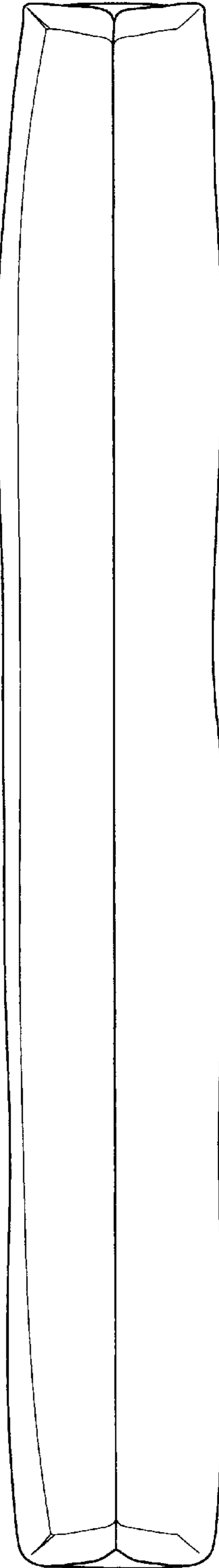

Fig. 4

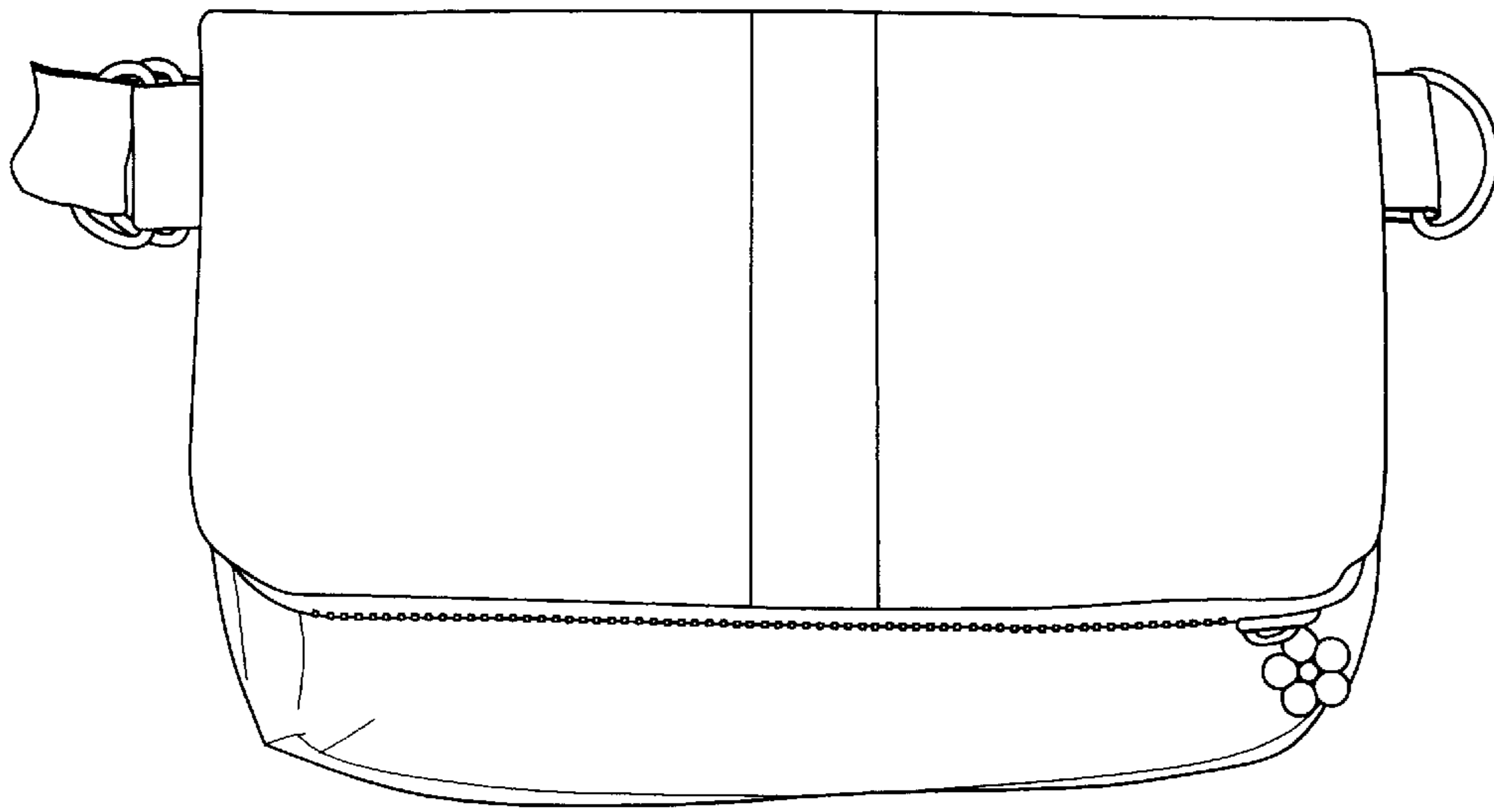

Fig. 5

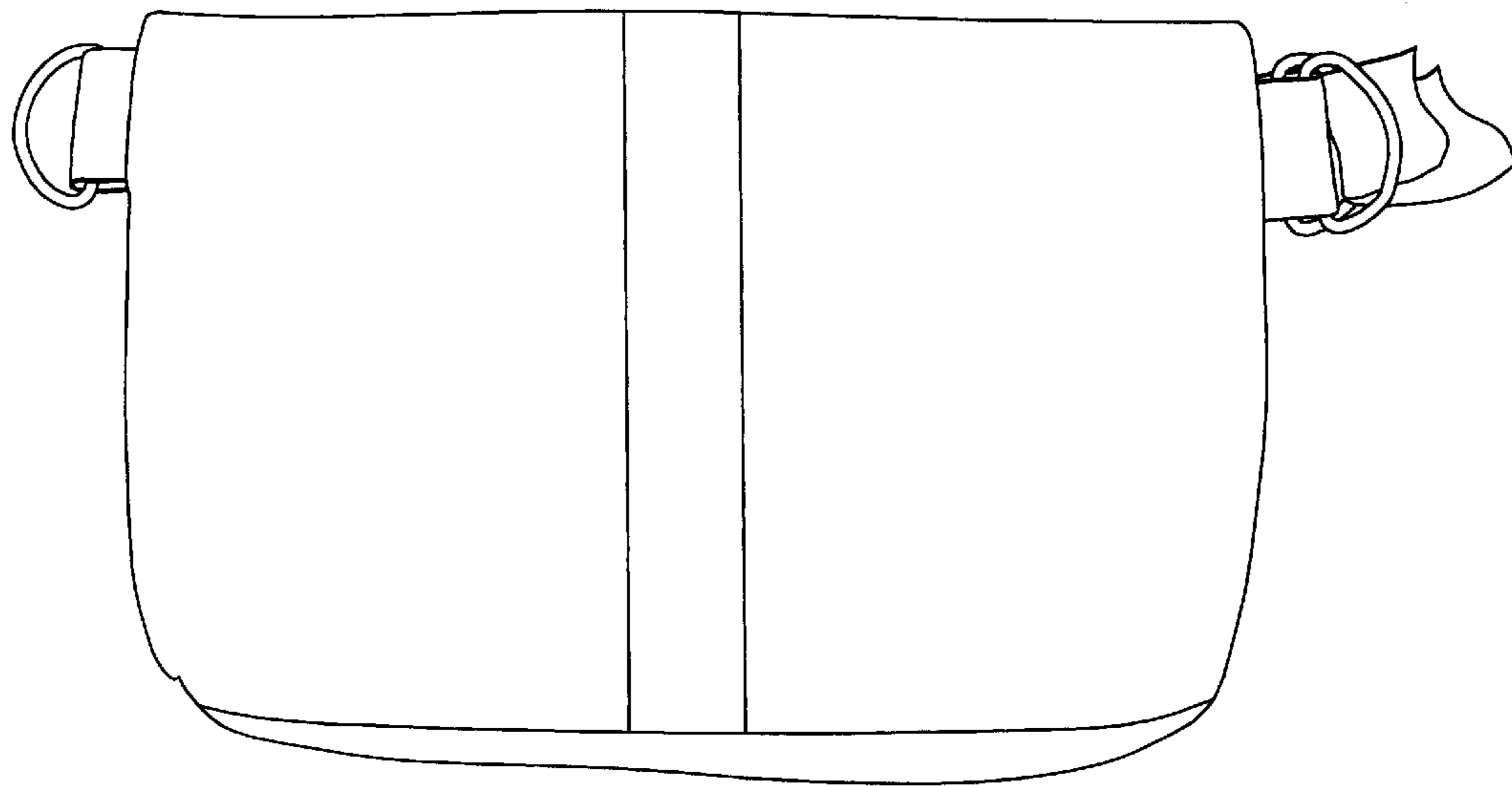

Fig. 6

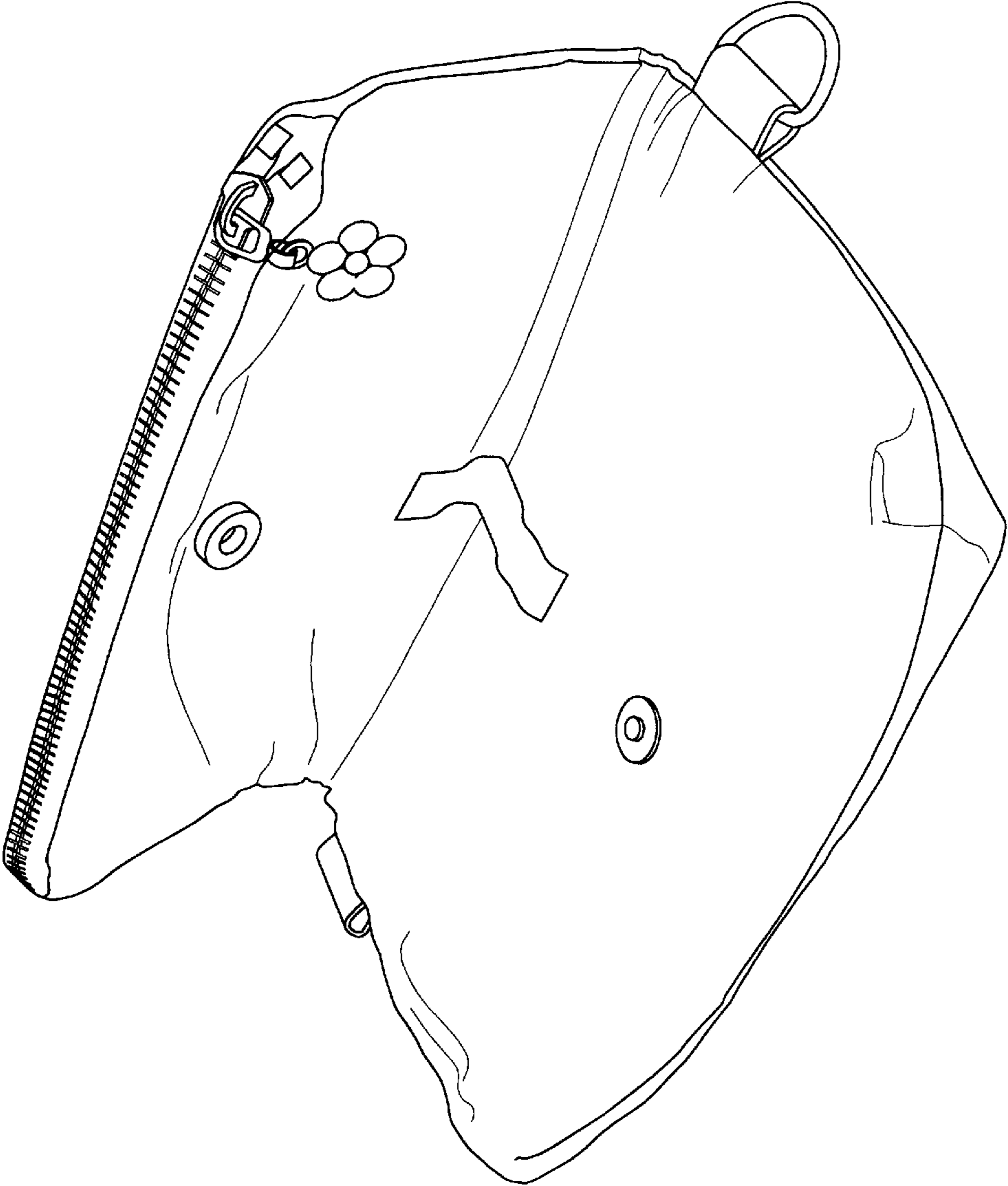

Fig. 7