



US00D533300S

(12) **United States Design Patent** (10) **Patent No.:** **US D533,300 S**
Schonbek et al. (45) **Date of Patent:** **** Dec. 5, 2006**

(54) **LIGHT FIXTURE**

(75) Inventors: **Andrew Schonbek**, Plattsburgh, NY (US); **Andrew Schuyler**, Colchester, VT (US)

(73) Assignee: **Schonbek Worldwide Lighting Inc.**, Plattsburgh, NY (US)

(**) Term: **14 Years**

(21) Appl. No.: **29/197,606**

(22) Filed: **Jan. 16, 2004**

(51) **LOC (8) Cl.** **26-99**

(52) **U.S. Cl.** **D26/155; D26/145**

(58) **Field of Classification Search** D26/81-92,
D26/138, 155, 143-145; 362/147, 404-408,
362/432

See application file for complete search history.

(56) **References Cited**

U.S. PATENT DOCUMENTS

D35,500 S	*	12/1901	Seips	D26/155
D64,924 S	*	6/1924	Newland	D26/155
D69,223 S	*	1/1926	Kranz	D26/155
D73,853 S	*	11/1927	McFadden	D26/155
1,658,206 A	*	2/1928	Matthyssen	362/405
D75,076 S	*	5/1928	Schreisman et al.	D26/145
D75,246 S	*	5/1928	Holdeman	D26/152
D75,634 S	*	6/1928	McFadden	D26/145
D77,019 S	*	11/1928	McFadden	D26/155
D77,615 S	*	1/1929	Logan	D26/145
D465,063 S	*	10/2002	De'Armond	D26/155

OTHER PUBLICATIONS

- Schonbek et al., pending U.S. Appl. No. 29/197,687, filed Jan. 16, 2004, entitled "Light Fixture,".
- Schonbek et al., pending U.S. Appl. No. 29/197,600, filed Jan. 16, 2004, entitled "Light Fixture,".
- Schonbek et al., pending U.S. Appl. No. 29/197,613, filed Jan. 16, 2004, entitled "Light Fixture Component,".
- Schonbek et al., pending U.S. Appl. No. 29/197,608, filed Jan. 16, 2004, entitled "Light Fixture Component,".
- Schonbek et al., pending U.S. Appl. No. 29/197,619, filed Jan. 16, 2004, entitled "Light Fixture Component,".

- Nuova Montart di Bianconi Leonardo, Nuova Montart Catalog, "#1288/6" Lighting Fixture, p. 4, (date unknown).
- Crystorama Lighting Group, Lights of Distinction Catalog, "#4706" Lighting Fixture, p. 4, (2002).
- Residential Lighting Magazine, "Palecek" twig "Lamp" Lighting Fixture, front page, (Sep. 2003).
- ABC Carpet & Home advertisement, Lighting Fixture, 1-page, (date unknown).
- Currey & Company catalog Lighting Fixtures, 1-page, (date unknown).
- Thomas Grant Chandeliers, Dallas Fort Worth Style Magazine, "Louis XV Style Gold Leafed Iron" Lighting Fixture, 1-page, (date unknown).
- Lighting fixtures available from Majic Lanterns by George, Christopher Wrays Lighting Emporium, and The Kessington Lighting Company, 1-page, (date unknown).
- Italian Venetian Fruit Chandelier, 1-page, (date unknown).
- Four Lighting Fixtures, 1-page (date unknown).
- Ferro, Met Home Catalog, Ferro Lighting Fixture, p. 38, (Jan./Feb. 2001).

* cited by examiner

Primary Examiner—Clare E Heflin

(74) *Attorney, Agent, or Firm*—Heslin Rothenberg Farley & Mesiti P.C.

(57) **CLAIM**

The ornamental design for a light fixture, as shown and described.

DESCRIPTION

FIG. 1 is a front elevational view of the light fixture of the present design, a rear elevational view being a mirror image thereof;

FIG. 2 is a left side elevational view thereof;

FIG. 3 is a right side elevational view thereof;

FIG. 4 is a top plan view thereof with additional portions shown in broken lines;

FIG. 5 is a bottom plan view thereof with additional portions shown in broken lines; and,

FIG. 6 is a top plan view of an alternative embodiment of the light fixture with additional portions shown in broken lines. The broken lines shown are for illustrative purposes only and form no part of the claimed design.

1 Claim, 6 Drawing Sheets

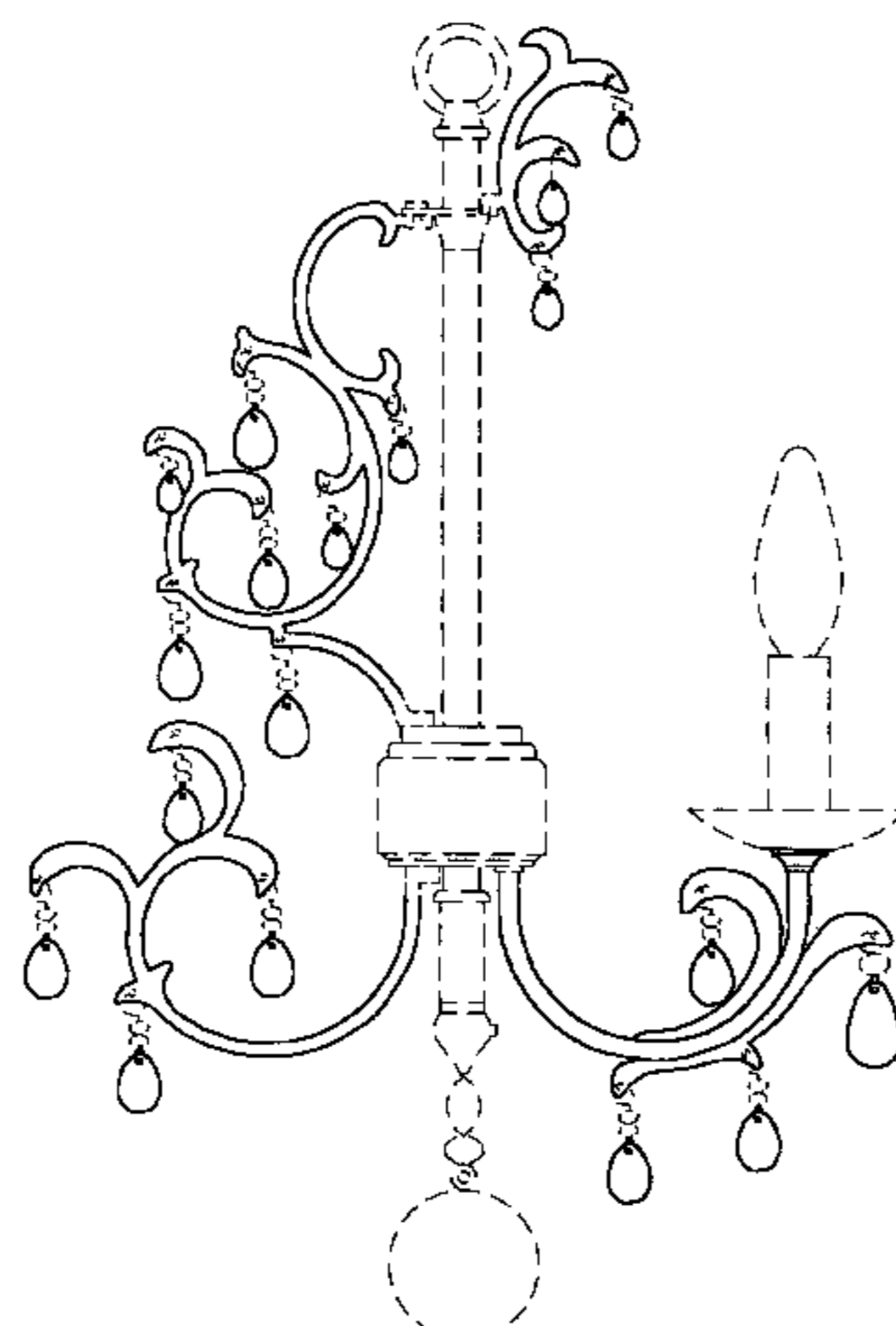

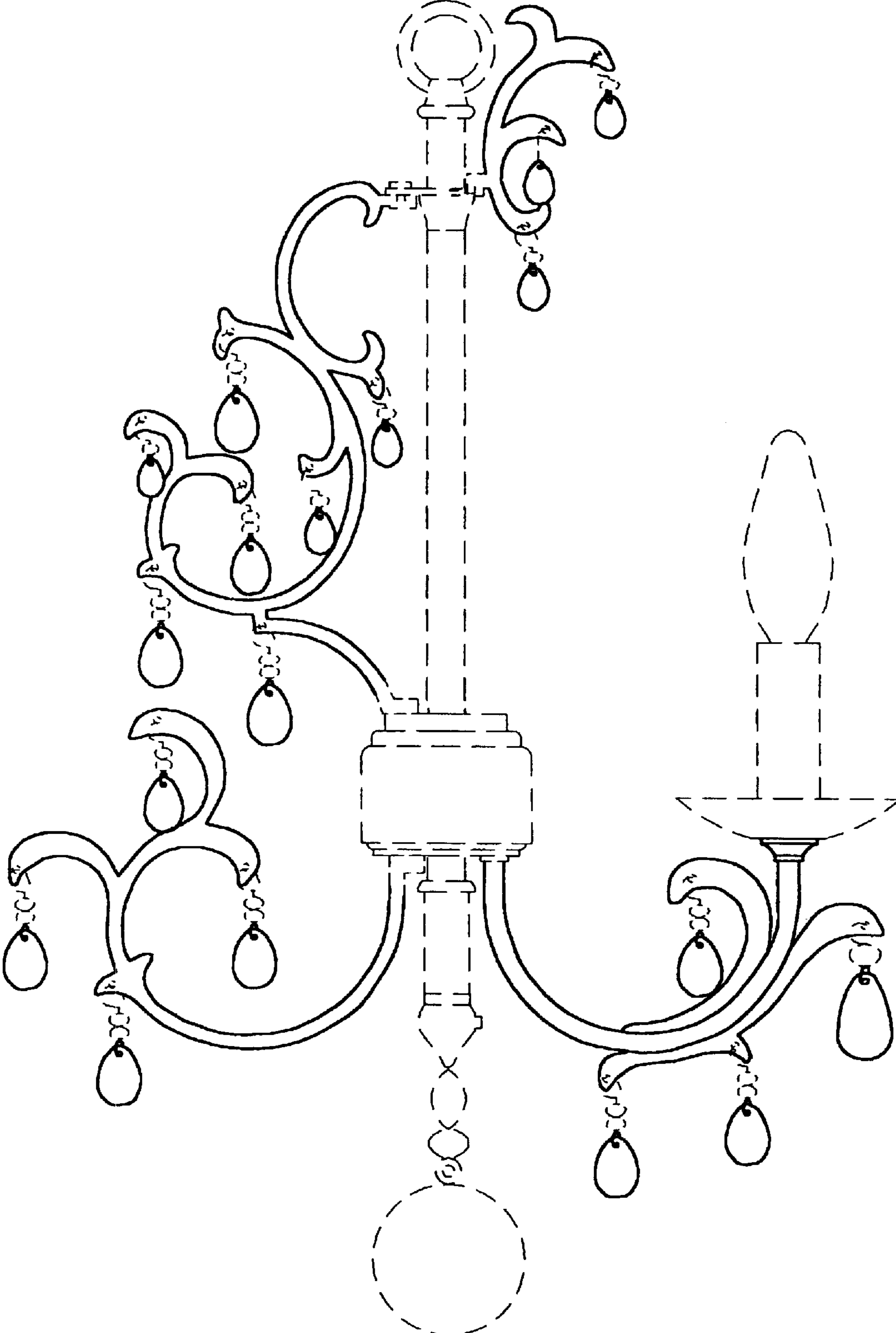

FIG. 1

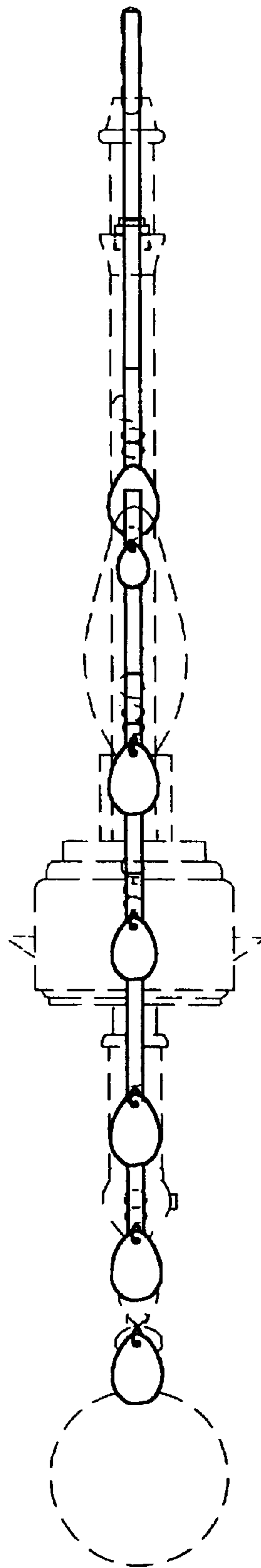

FIG. 2

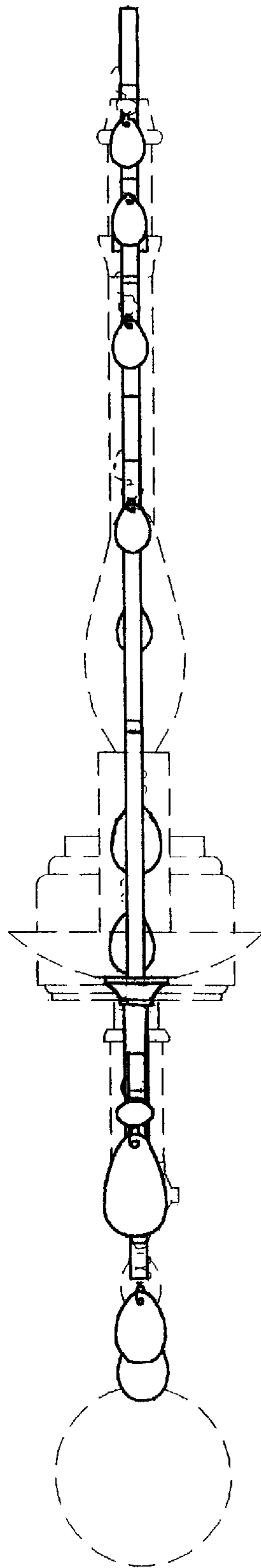

FIG. 3

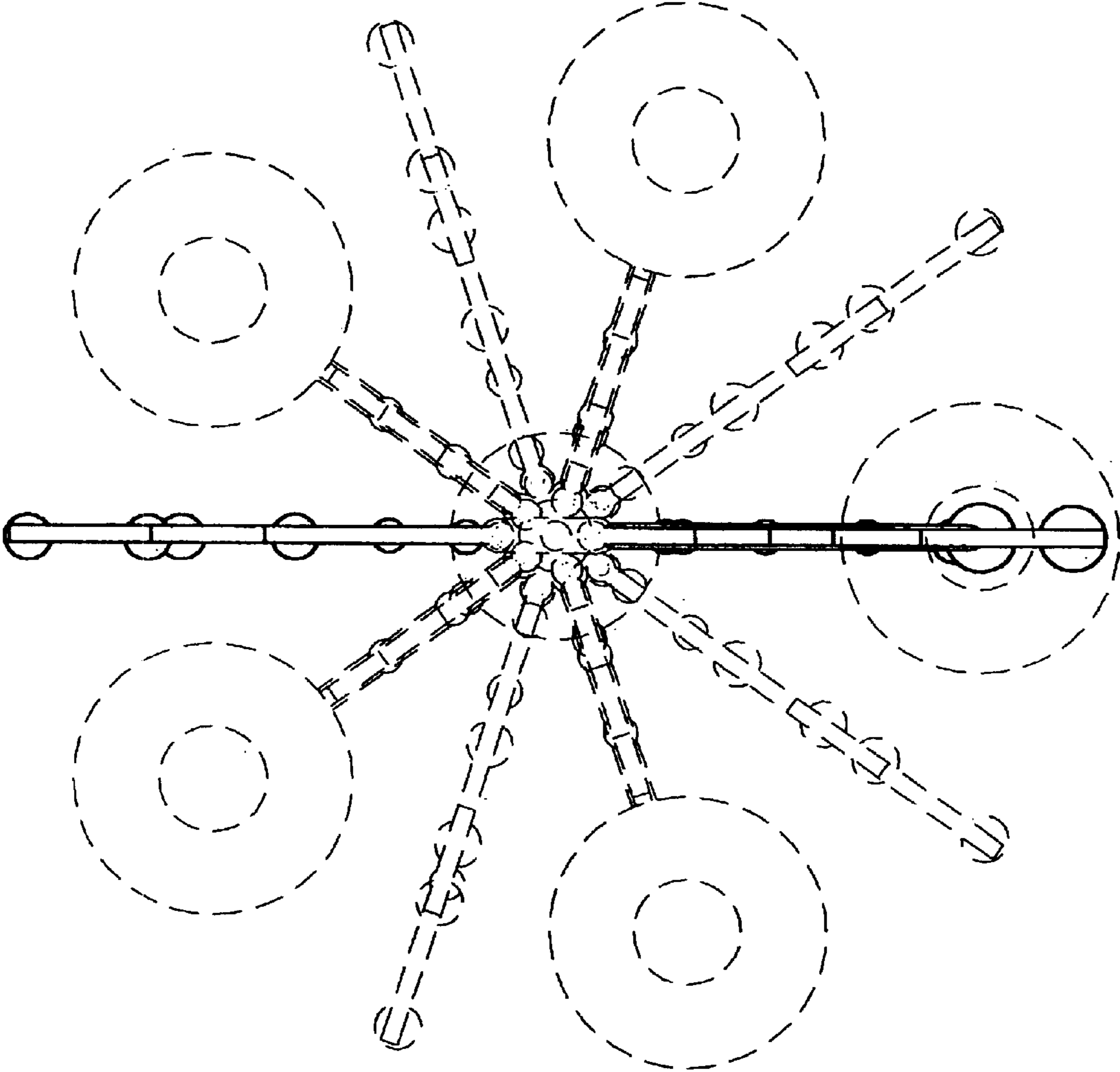

FIG. 4

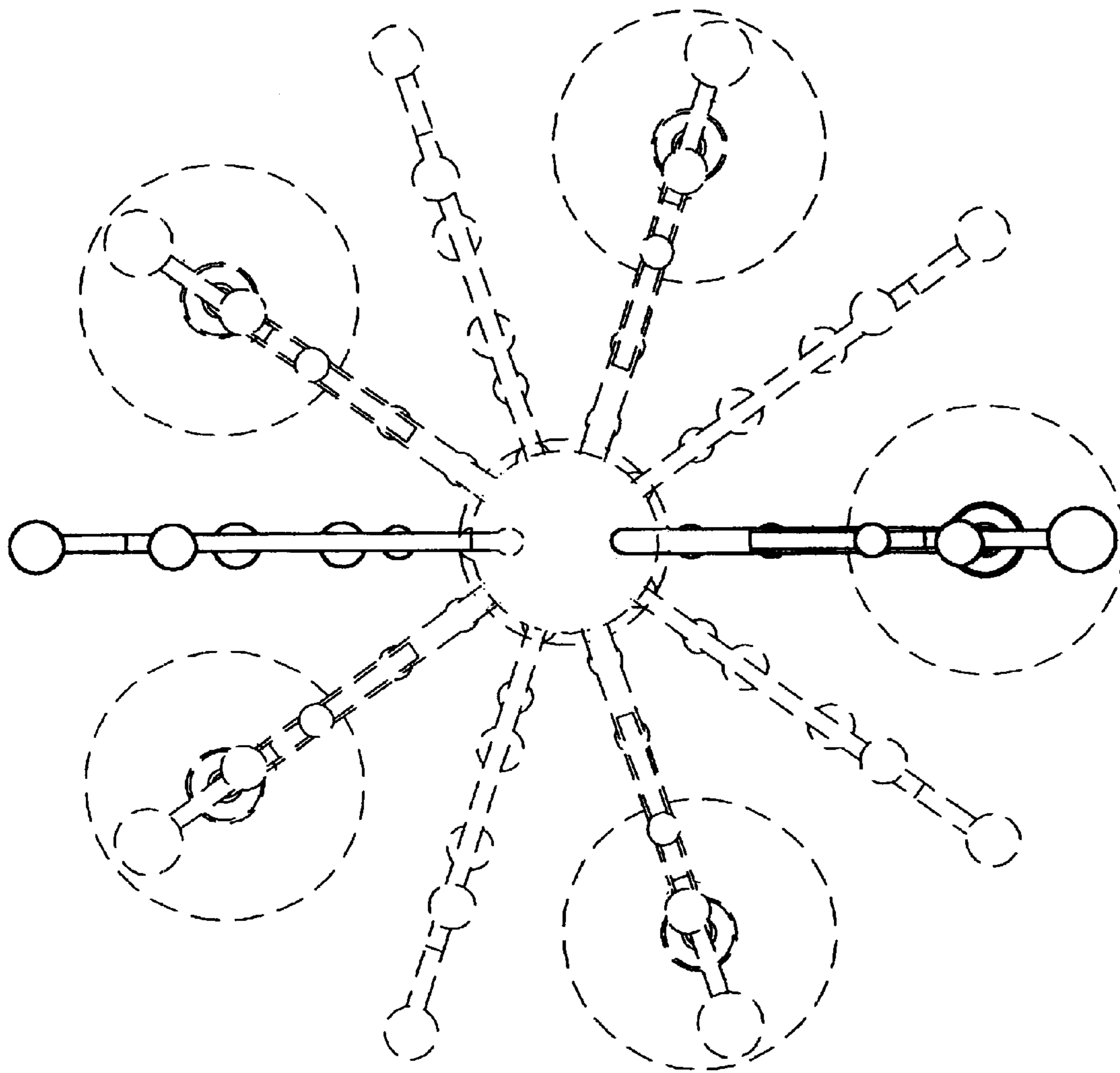

FIG. 5

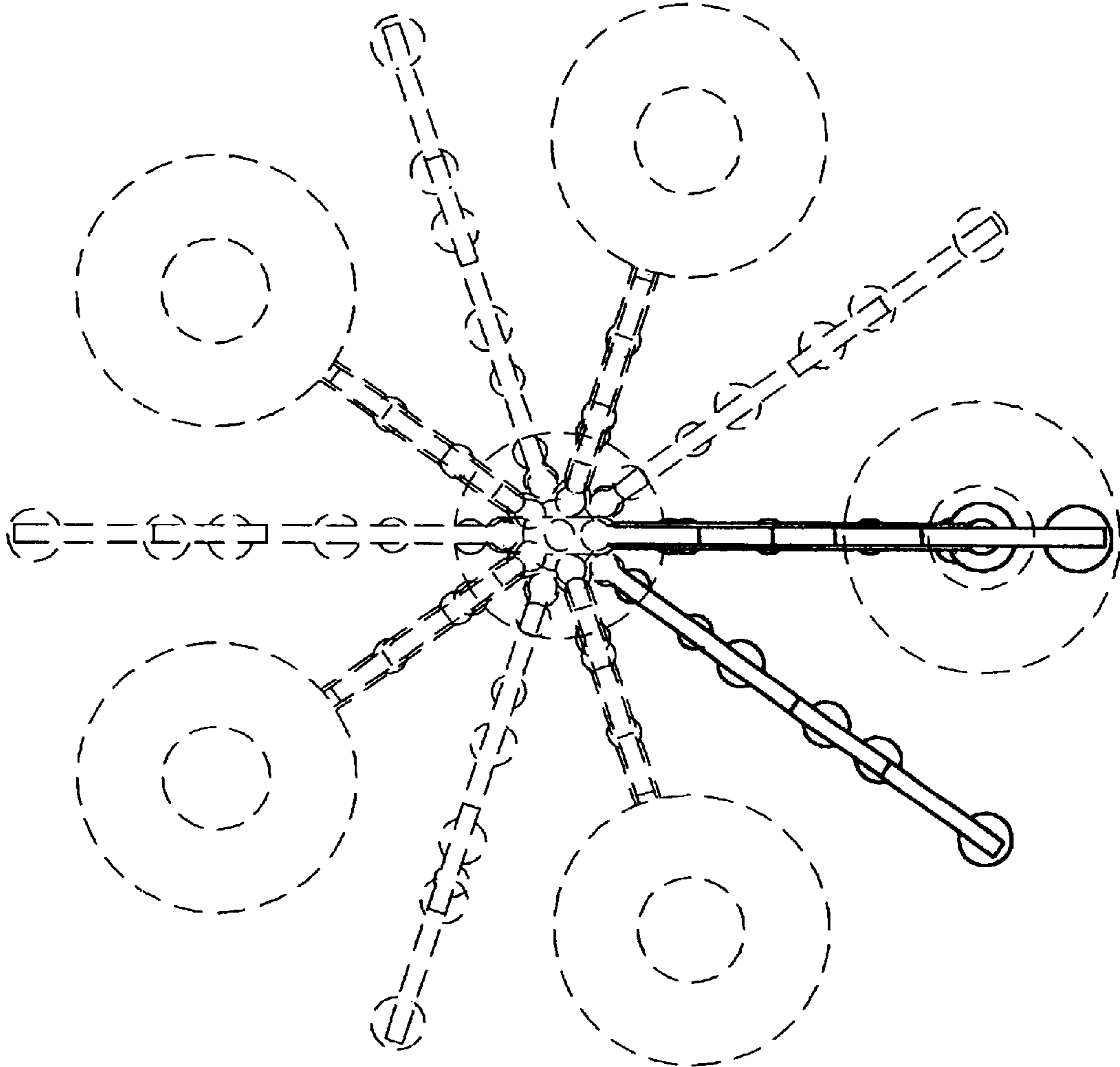

FIG. 6