



US00D533103S

(12) **United States Design Patent**
Swarovski

(10) **Patent No.:** **US D533,103 S**

(45) **Date of Patent:** **** Dec. 5, 2006**

(54) **OBJECT MADE OF GLASS/GEMSTONE**

(75) **Inventor:** **Helmut Swarovski, Fritzens (AT)**

(73) **Assignee:** **Swarovski Aktiengesellschaft, Triesen (LI)**

(**) **Term:** **14 Years**

(21) **Appl. No.:** **29/211,811**

(22) **Filed:** **Aug. 23, 2004**

(30) **Foreign Application Priority Data**

Feb. 24, 2004 (EM) 137450

(51) **LOC (8) Cl.** **11-01**

(52) **U.S. Cl.** **D11/90**

(58) **Field of Classification Search** D11/1-2,
D11/26-29, 89-92; 63/26-28, 32

See application file for complete search history.

(56) **References Cited**

U.S. PATENT DOCUMENTS

D407,036 S	*	3/1999	Reisigl	D11/90
D409,944 S	*	5/1999	Reisigl	D11/90
D430,060 S	*	8/2000	Kavalek	D11/90
D431,794 S	*	10/2000	Reisigl	D11/90
D434,341 S	*	11/2000	Kavalek	D11/90
D434,691 S	*	12/2000	Swarovski	D11/90
D435,477 S	*	12/2000	Kavalek	D11/90
D440,522 S	*	4/2001	Swarovski	D11/90
D441,684 S	*	5/2001	Kavalek	D11/90
D441,685 S	*	5/2001	Koucky et al.	D11/90
D442,513 S	*	5/2001	Kavalek	D11/90
D442,881 S	*	5/2001	Kavalek	D11/90
D460,376 S	*	7/2002	Bamminger et al.	D11/90
6,422,039 B1	*	7/2002	Bamminger et al.	63/32
D463,313 S	*	9/2002	Bamminger et al.	D11/90

D482,985 S	*	12/2003	Bombeke	D11/90
D487,411 S	*	3/2004	Bamminger et al.	D11/90
D487,712 S	*	3/2004	Bamminger et al.	D11/90
6,705,114 B1	*	3/2004	Steiner	63/32
D511,987 S	*	11/2005	Swarovski	D11/90

* cited by examiner

Primary Examiner—Ralf Seifert

(74) *Attorney, Agent, or Firm*—Wenderoth, Lind & Ponack, L.L.P.

(57) **CLAIM**

I claim the ornamental design for an object made of glass/gemstone, as shown and described.

DESCRIPTION

FIG. 1 is a front perspective view of an ornamental object made of glass/gemstone according to the present design;

FIG. 2 is a rear perspective view;

FIG. 3 is a front view;

FIG. 4 is a rear view;

FIG. 5 is bottom view;

FIG. 6 is a top view;

FIG. 7 is a left side view;

FIG. 8 is a right side view;

FIG. 9 is a front perspective view of a second embodiment of an ornamental object made of glass/gemstone according to the present design;

FIG. 10 is a rear perspective view of the second embodiment;

FIG. 11 is a front view of the second embodiment;

FIG. 12 is a rear view of the second embodiment;

FIG. 13 is a bottom view of the second embodiment;

FIG. 14 is a top view of the second embodiment;

FIG. 15 is a right side view of the second embodiment; and,

FIG. 16 is a left side view of the second embodiment.

1 Claim, 2 Drawing Sheets

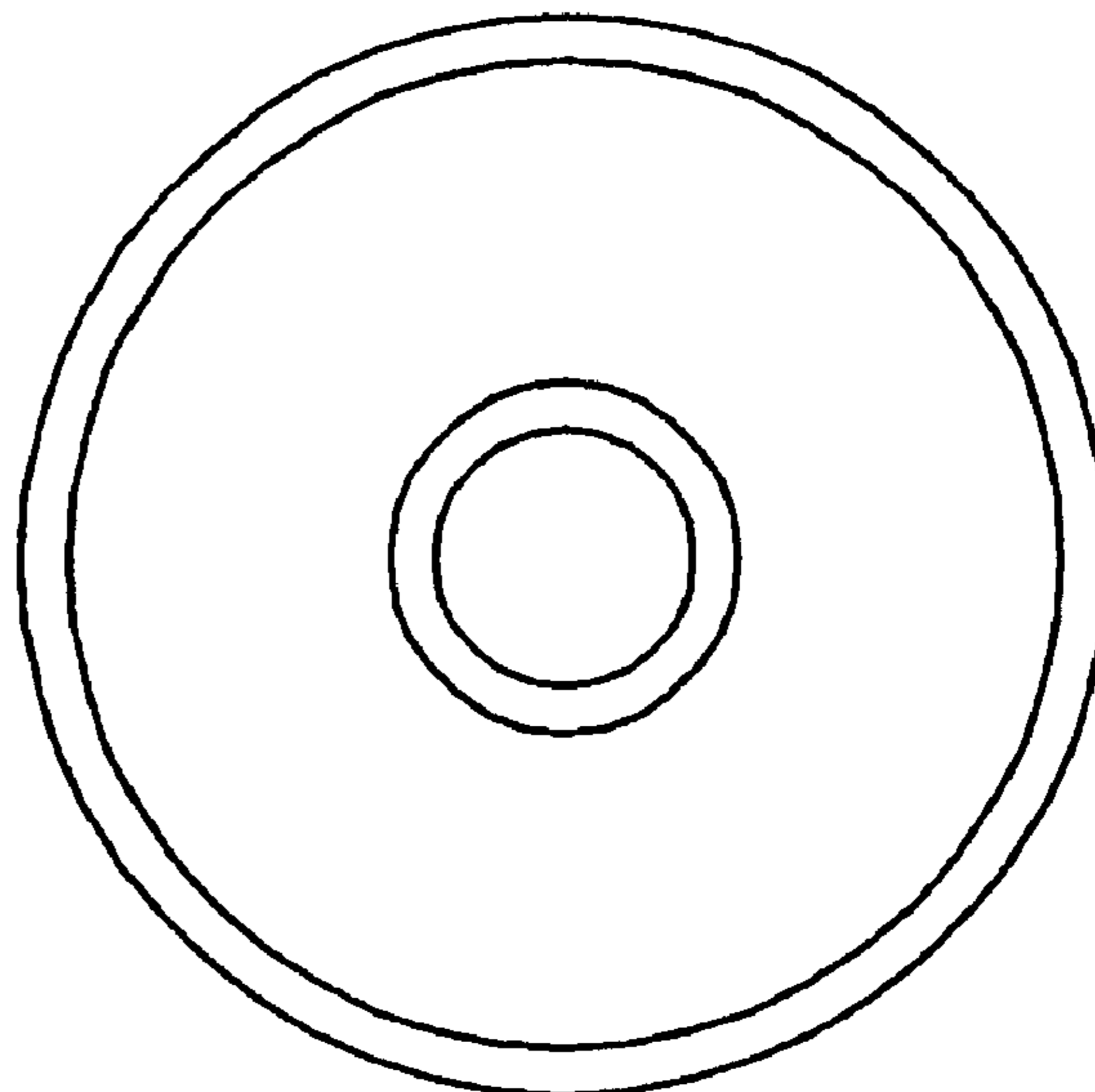
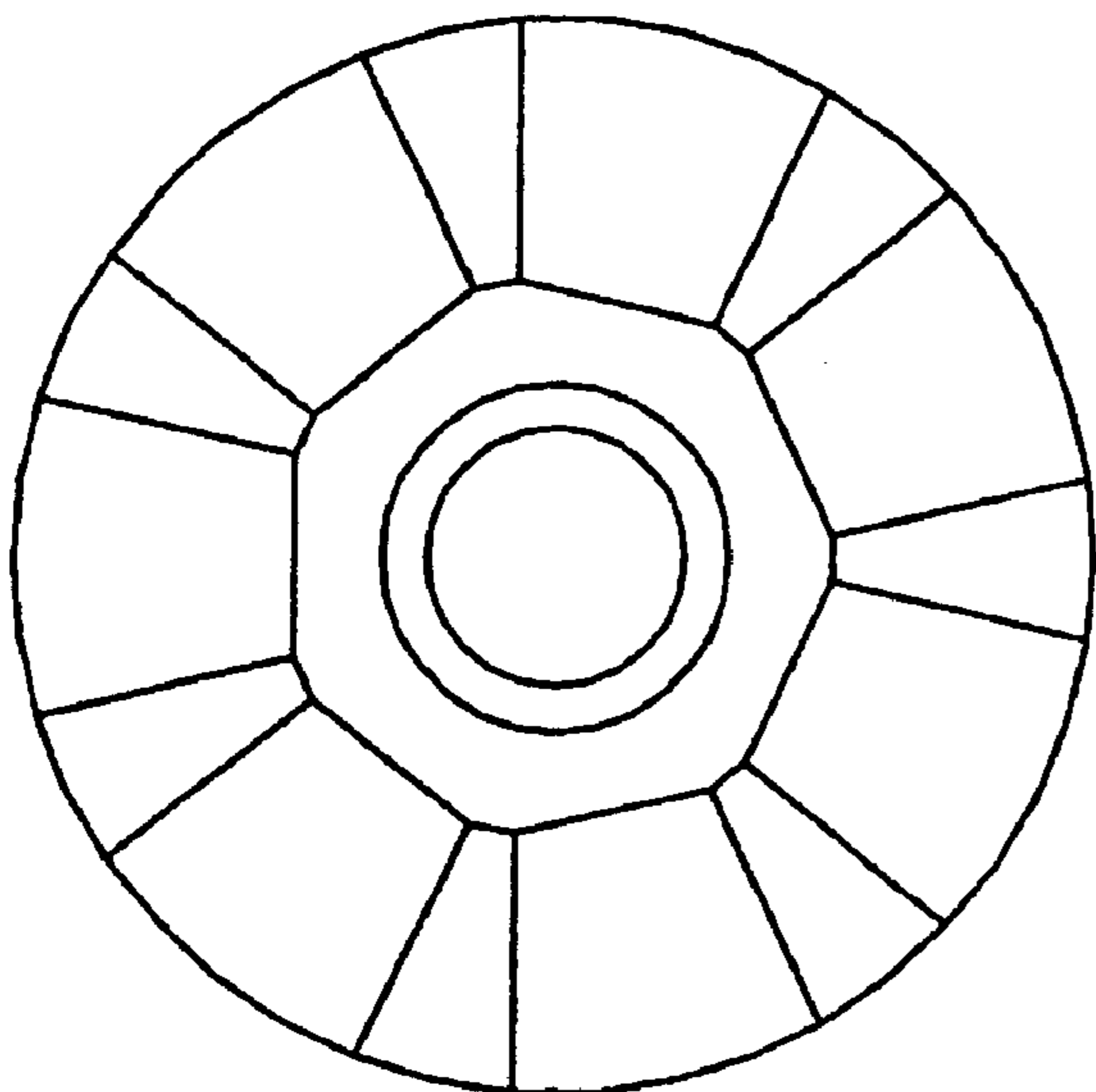

FIG. 1

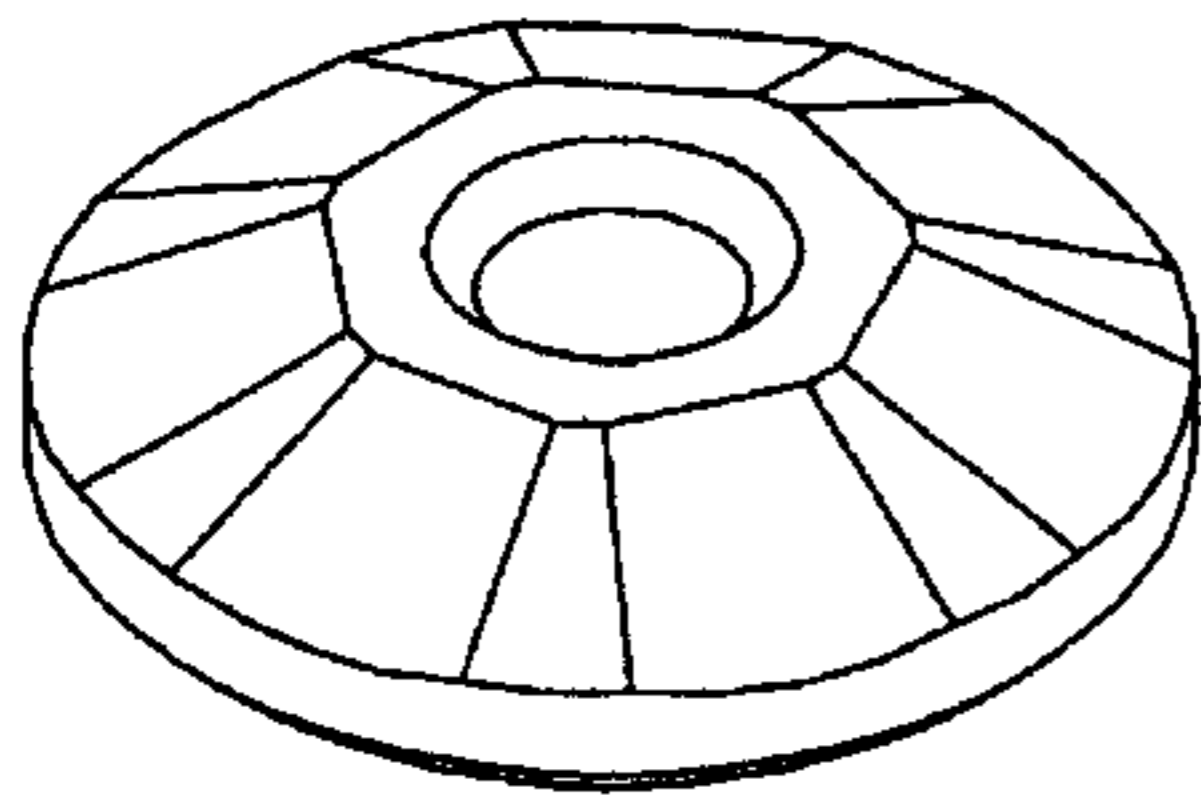

FIG. 2

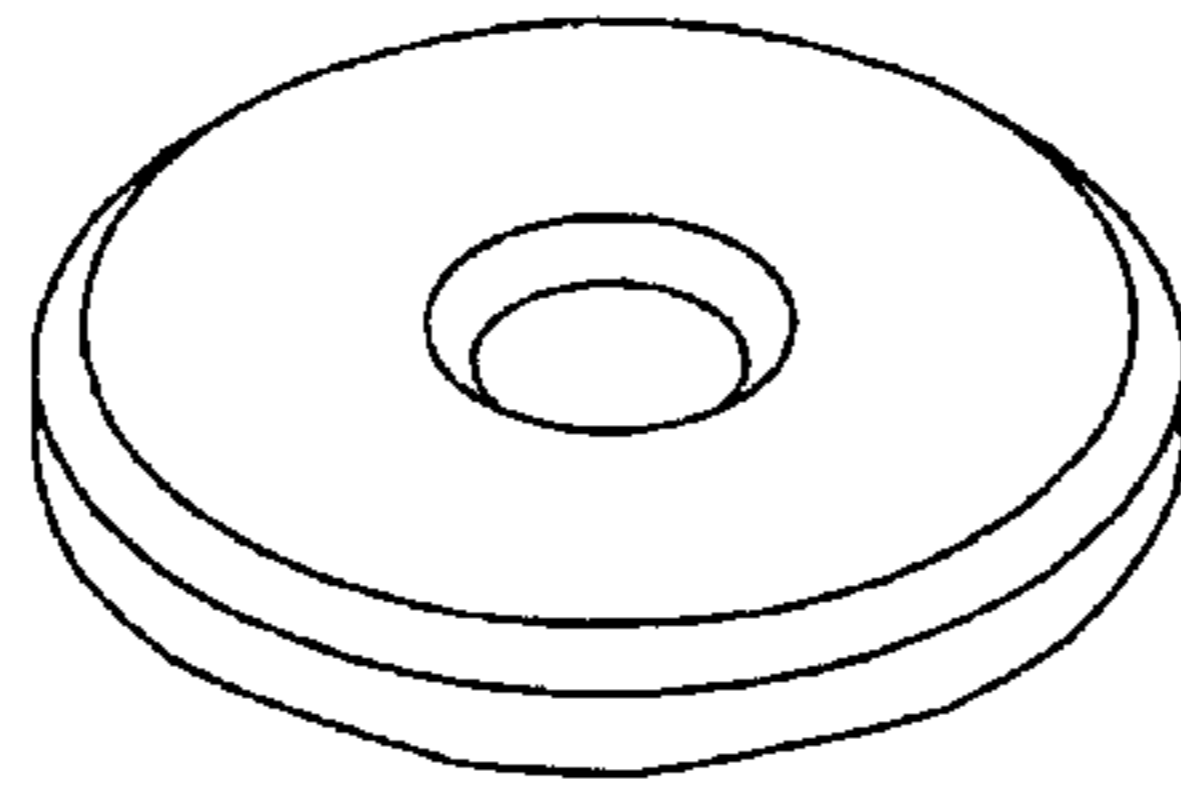

FIG. 3

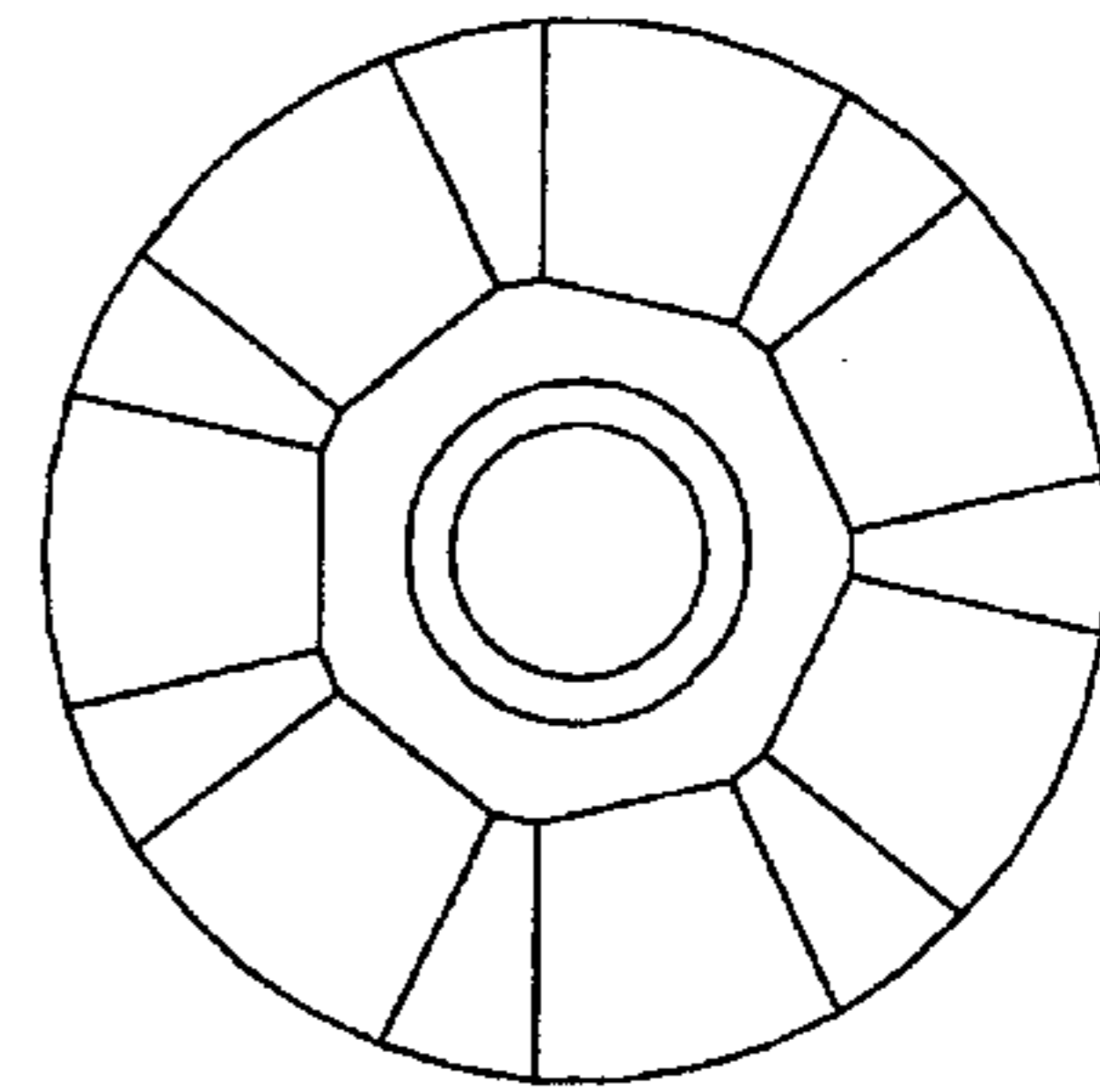

FIG. 4

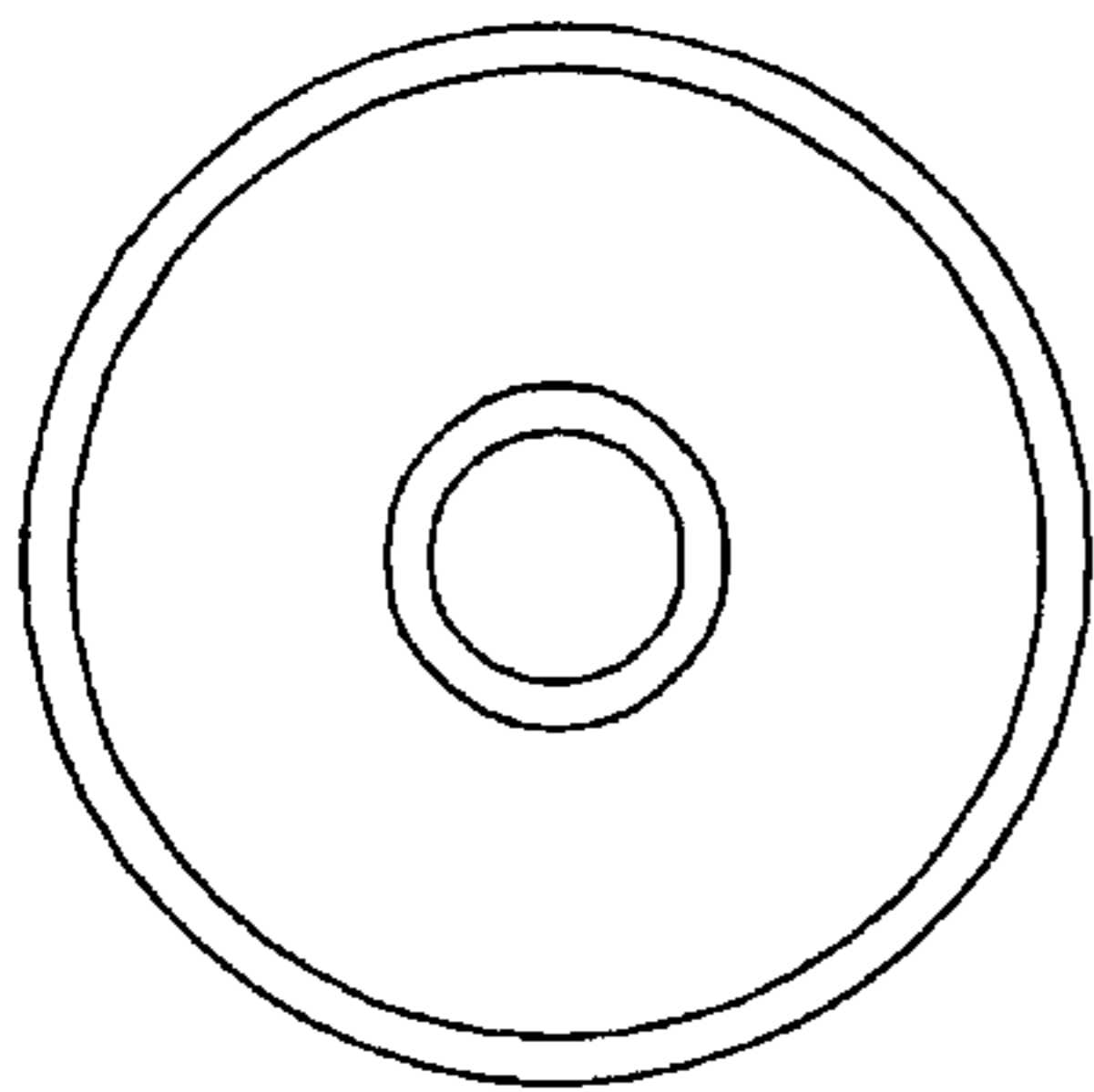

FIG. 5



FIG. 6

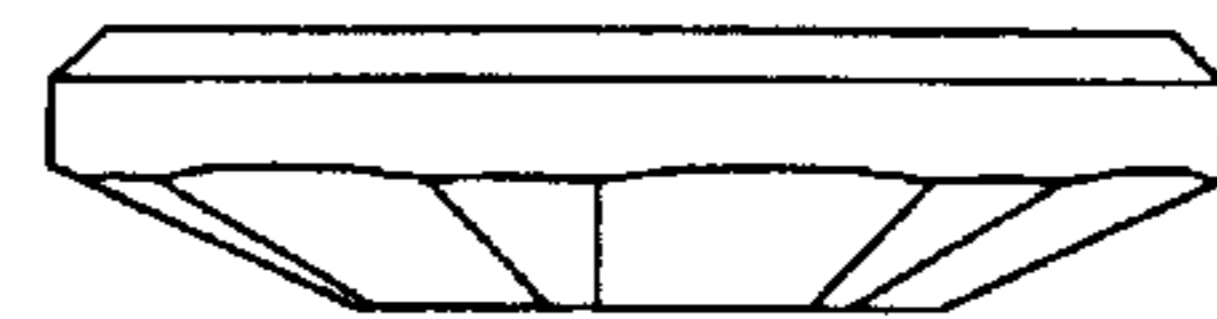

FIG. 7

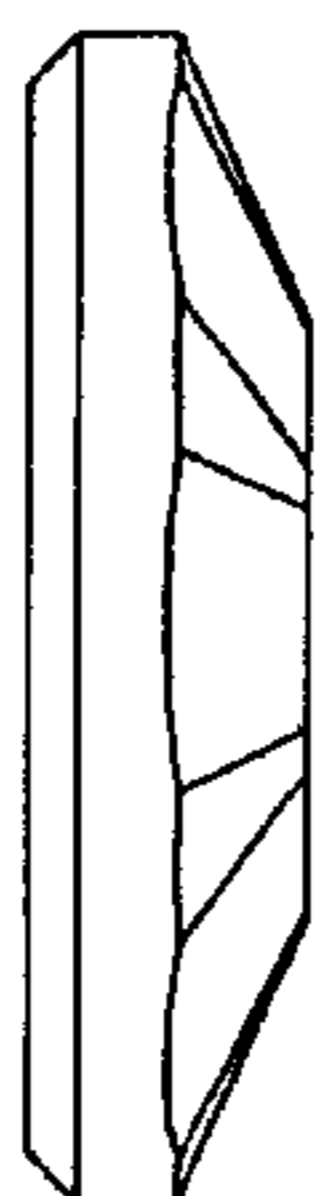

FIG. 8



FIG. 9

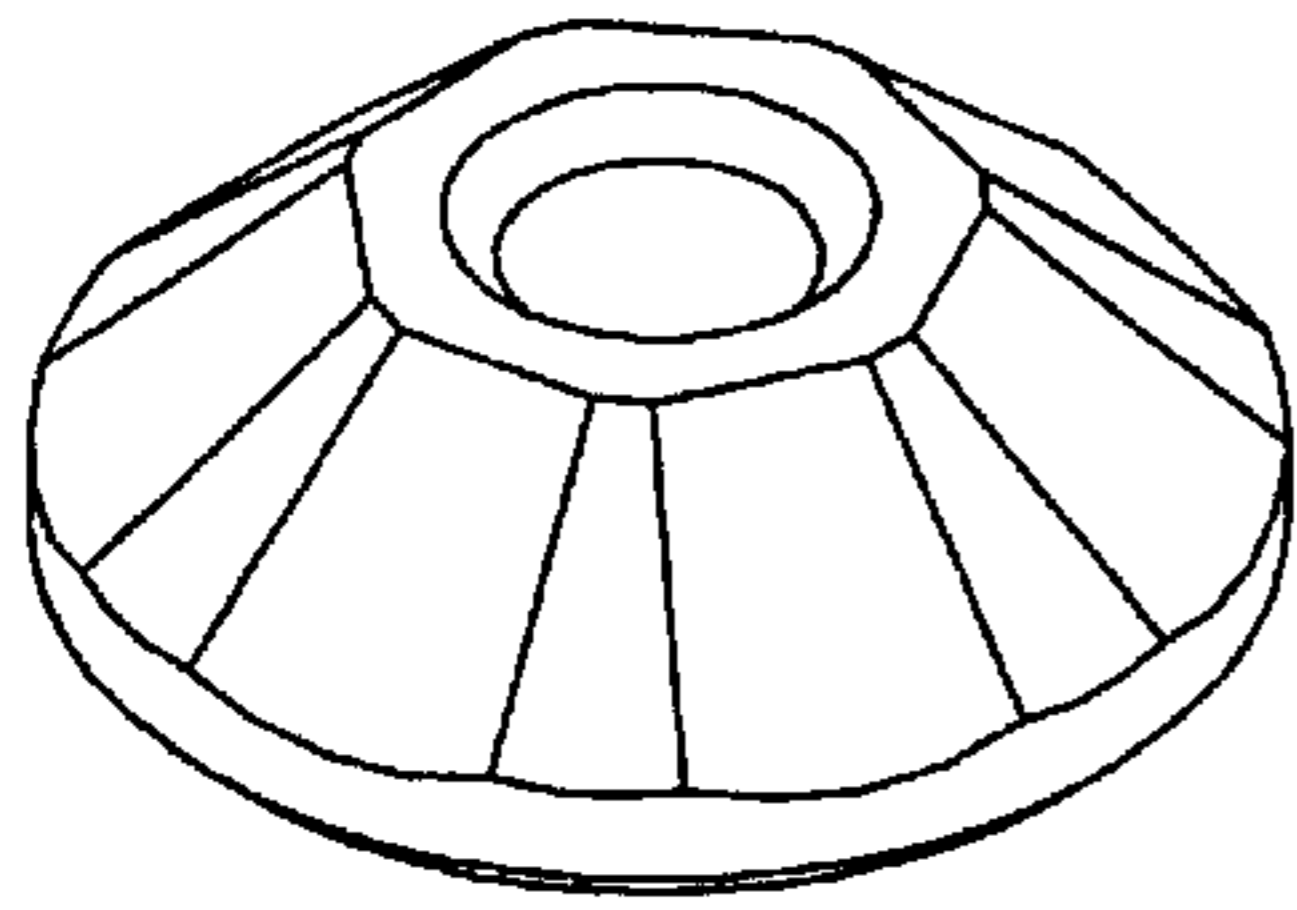

FIG. 10

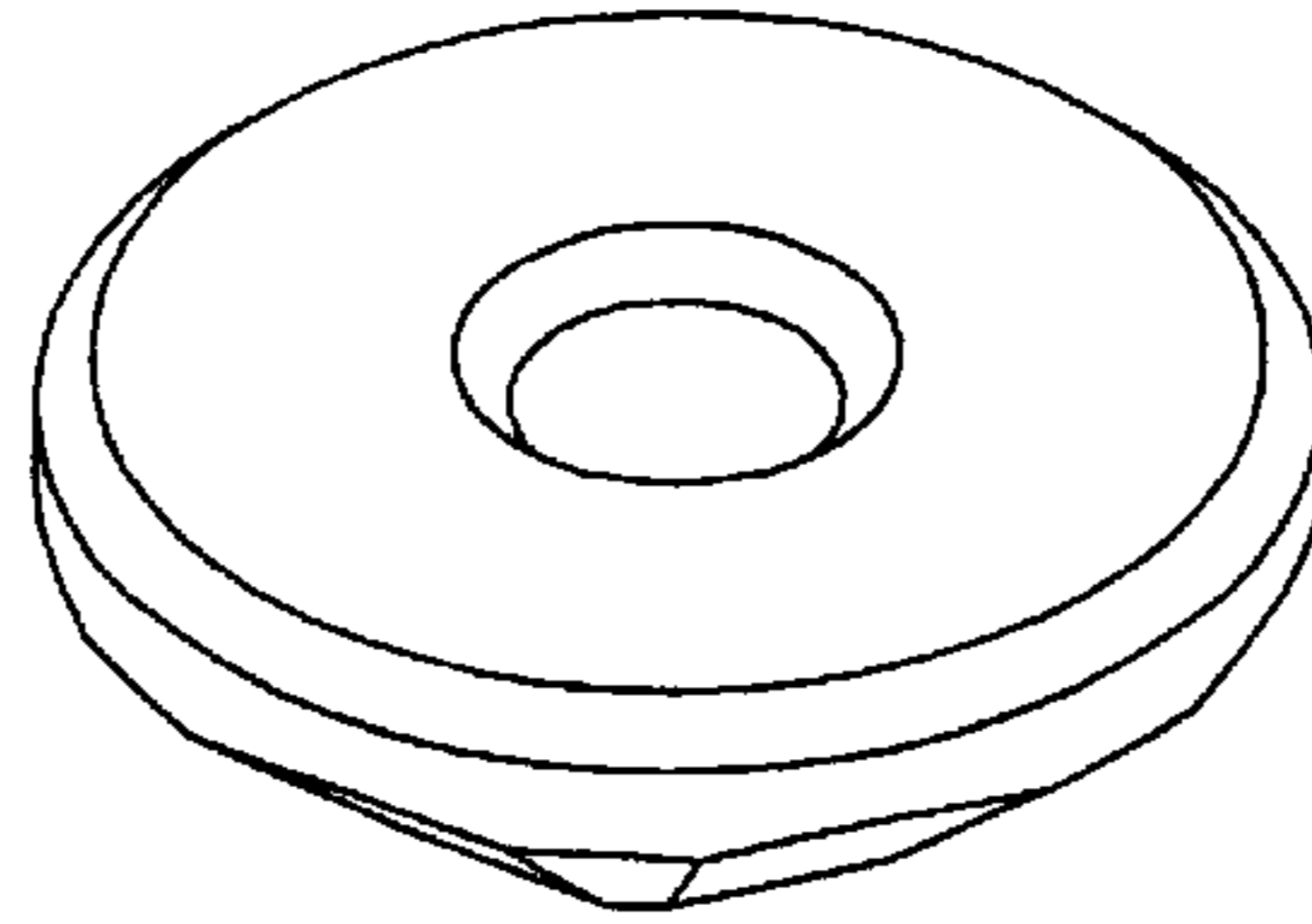

FIG. 11

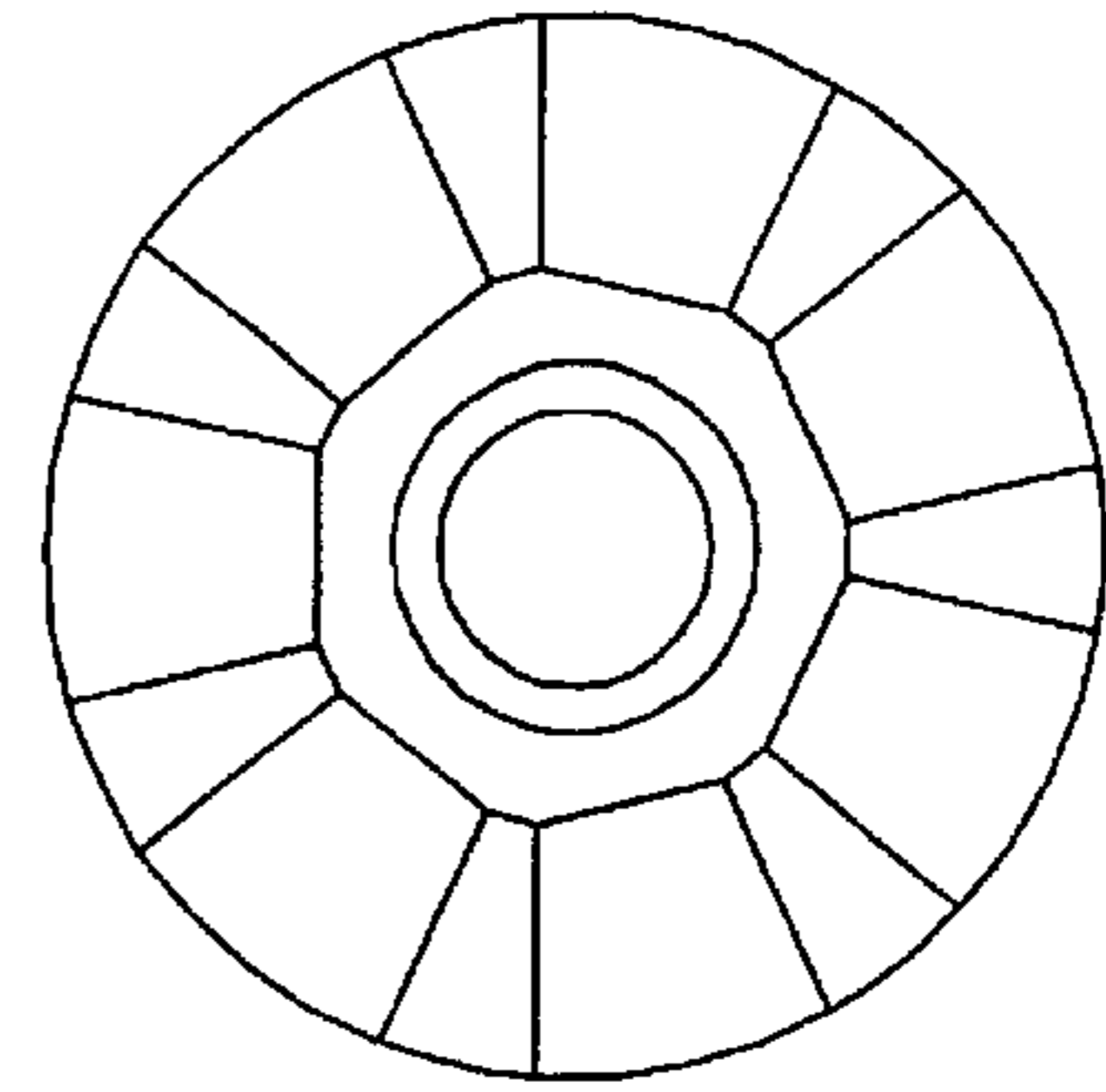

FIG. 12

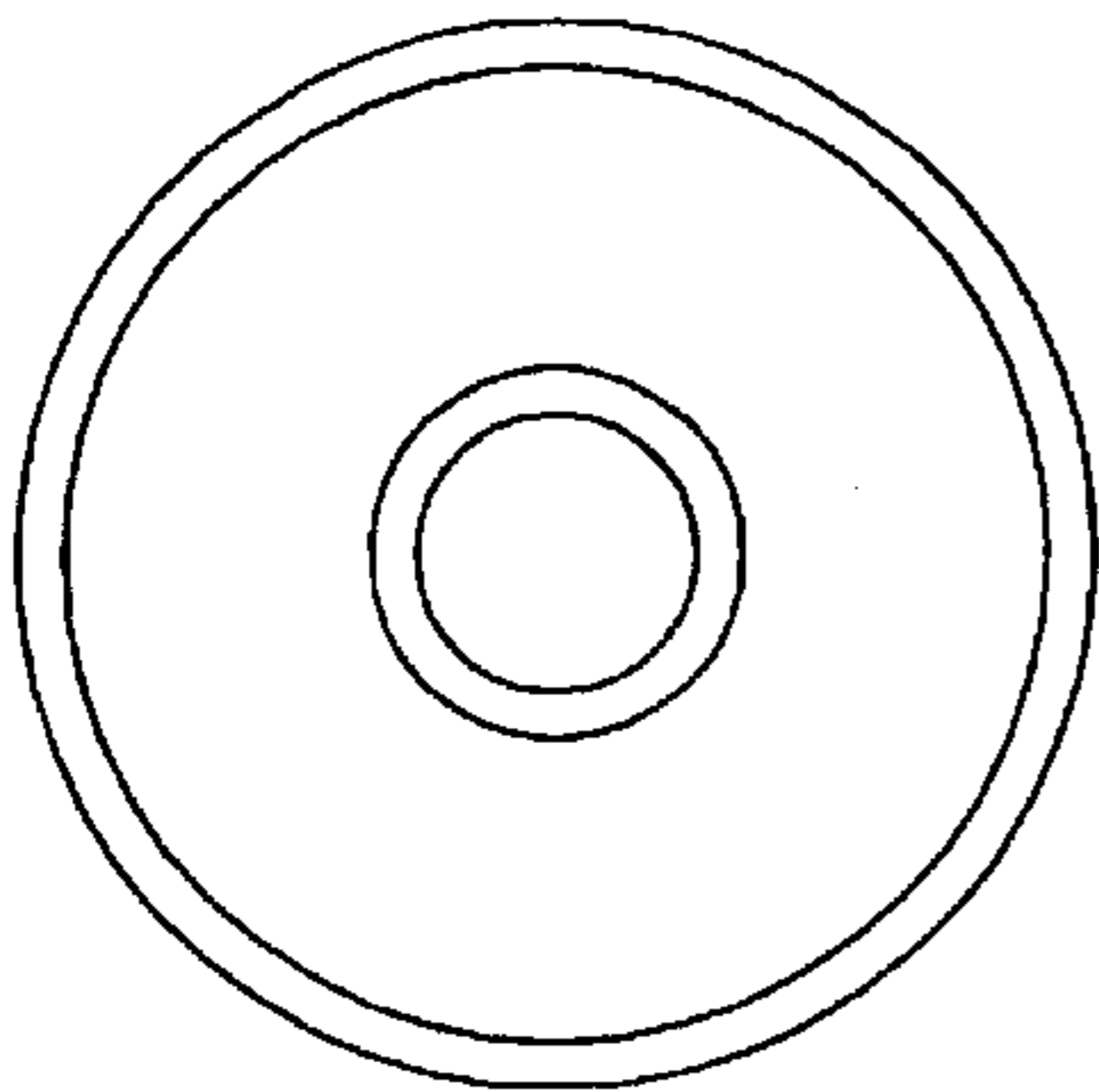

FIG. 13

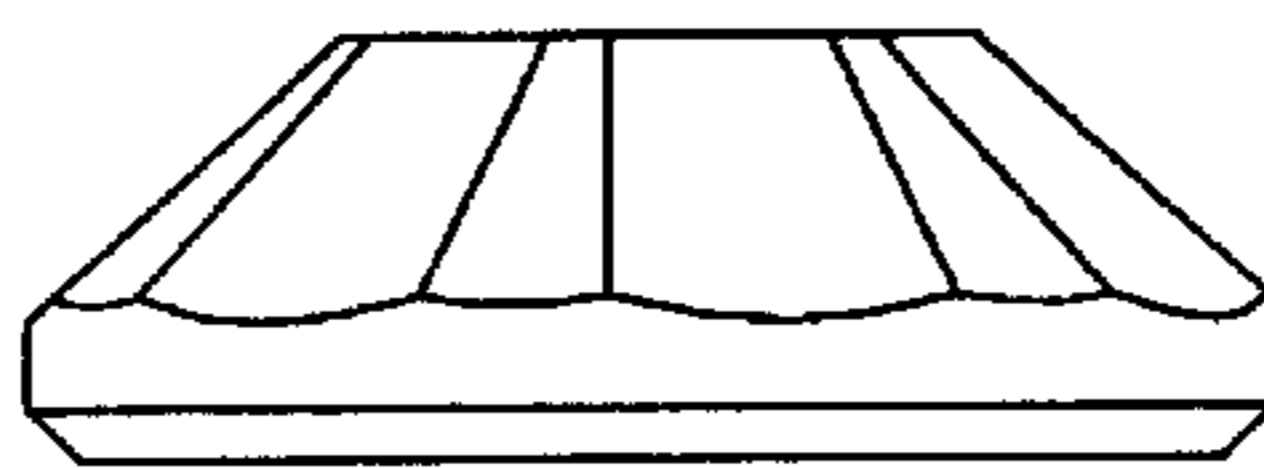

FIG. 14

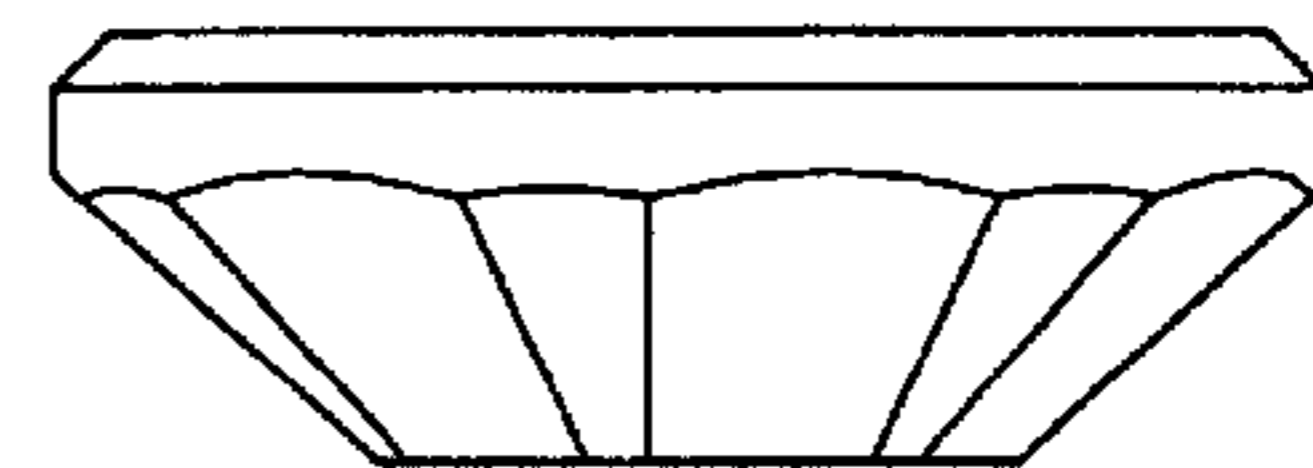

FIG. 15

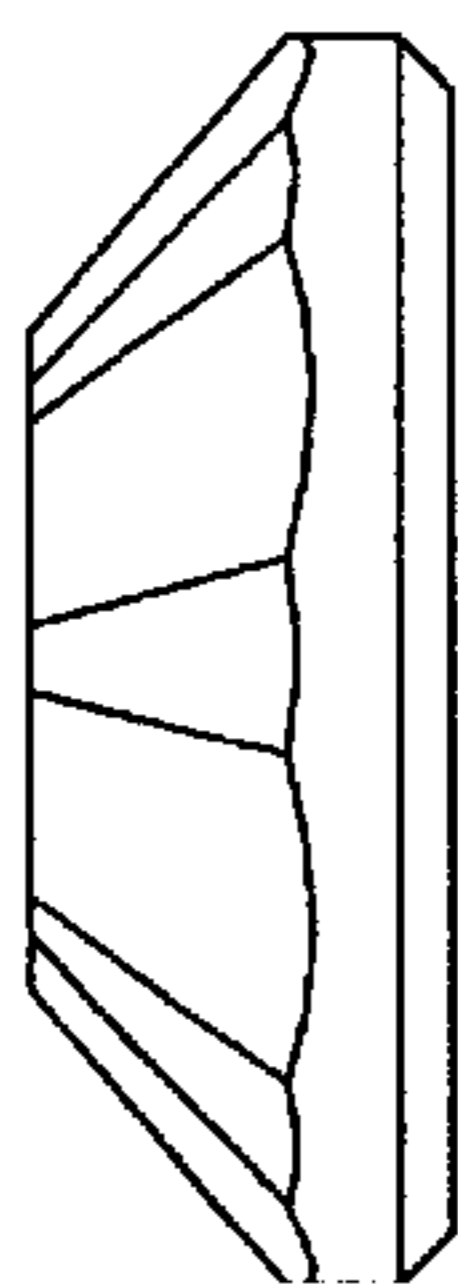

FIG. 16

