



US00D533079S

(12) **United States Design Patent**  
**Berger**

(10) **Patent No.:** **US D533,079 S**

(45) **Date of Patent:** **\*\* Dec. 5, 2006**

(54) **ARRAY OF PRODUCT DISPENSERS**

(75) Inventor: **Russell Berger**, Needham, MA (US)

(73) Assignee: **SKJP Holdings, LLC**, Naples, FL (US)

(\*\*) Term: **14 Years**

(21) Appl. No.: **29/217,413**

(22) Filed: **Nov. 17, 2004**

(51) **LOC (8) Cl.** ..... **09-03**

(52) **U.S. Cl.** ..... **D9/756; D6/515**

(58) **Field of Classification Search** ..... D9/756,  
D9/737, 730, 734, 720, 414, 415, 418, 424;  
D6/515-523; 206/389, 391; 211/13.1; 221/173,  
221/282; 242/570, 590, 588.1, 598, 588.6;  
312/34.1, 34.8

See application file for complete search history.

(56) **References Cited**

**U.S. PATENT DOCUMENTS**

D166,782 S	*	5/1952	Weskna	.....	D6/523
D392,482 S	*	3/1998	Seenath	.....	D6/515
D422,818 S	*	4/2000	Fletcher	.....	D6/518
D430,013 S	*	8/2000	Shurtleff et al.	.....	D9/749
D437,167 S	*	2/2001	Hardaway	.....	D6/570
D452,094 S	*	12/2001	Akin	.....	D6/515
D462,860 S	*	9/2002	Orlando	.....	D6/518

D467,106 S	*	12/2002	Bohay	.....	D6/523
D480,901 S	*	10/2003	Millington	.....	D6/518
D482,915 S	*	12/2003	Yang et al.	.....	D6/515
D495,544 S	*	9/2004	Tan	.....	D6/515
2004/0245067 A1	*	12/2004	Jones	.....	194/327

\* cited by examiner

*Primary Examiner*—Stella Reid

*Assistant Examiner*—Mark Goodwin

(74) *Attorney, Agent, or Firm*—Barlow, Josephs & Holmes, Ltd.

(57) **CLAIM**

The ornamental design for an array of product dispensers, as shown and described.

**DESCRIPTION**

FIG. 1 is a perspective view of an array of product dispensers showing my new design, the broken lines being of a product contained in the dispenser which forms no part of the claimed design;

FIG. 2 is a top view thereof;

FIG. 3 is a bottom view thereof;

FIG. 4 is a front elevational view thereof;

FIG. 5 is a rear elevational view thereof;

FIG. 6 is a left side elevational view thereof; and,

FIG. 7 is a right side elevational view thereof.

**1 Claim, 5 Drawing Sheets**

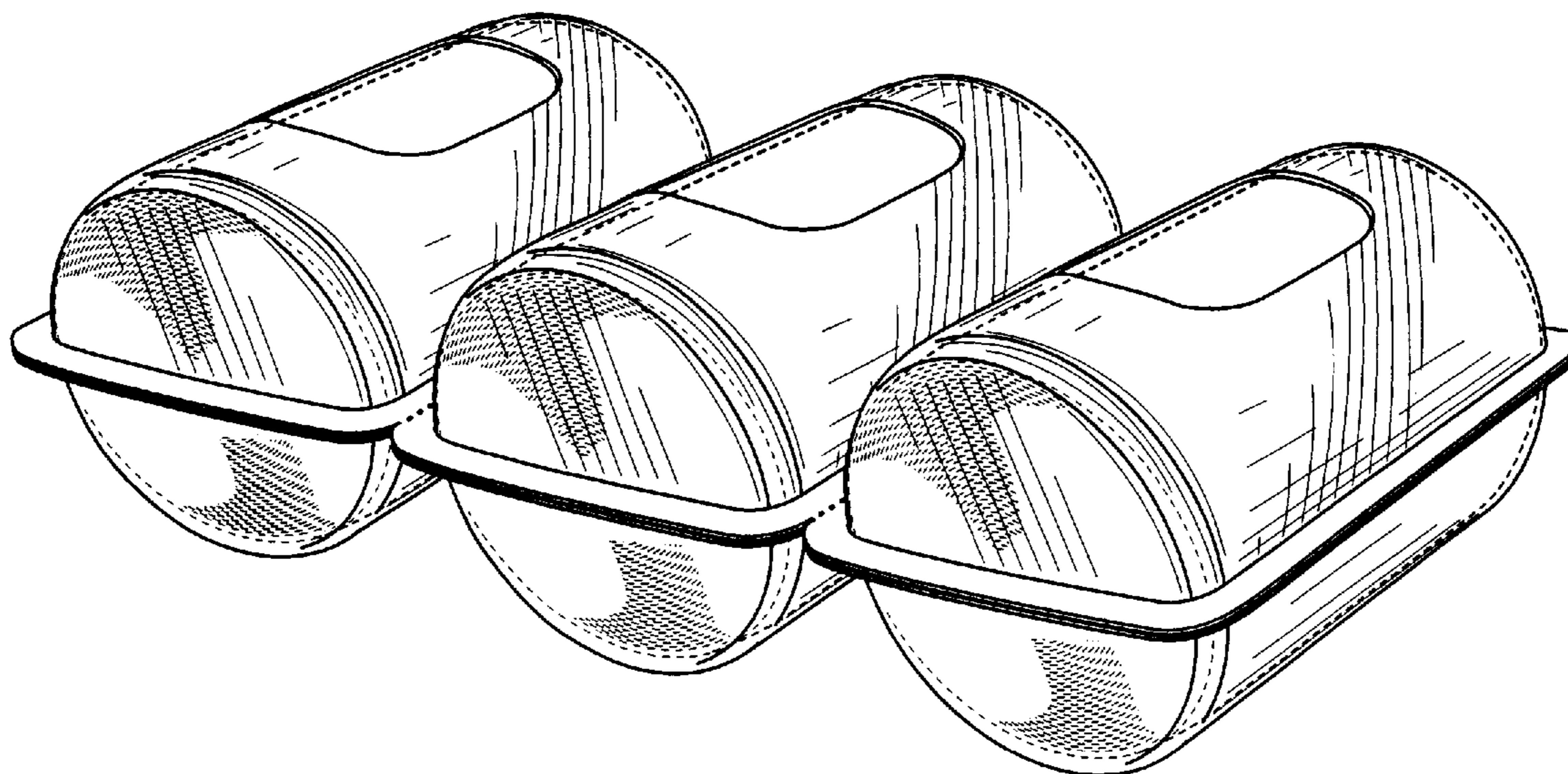

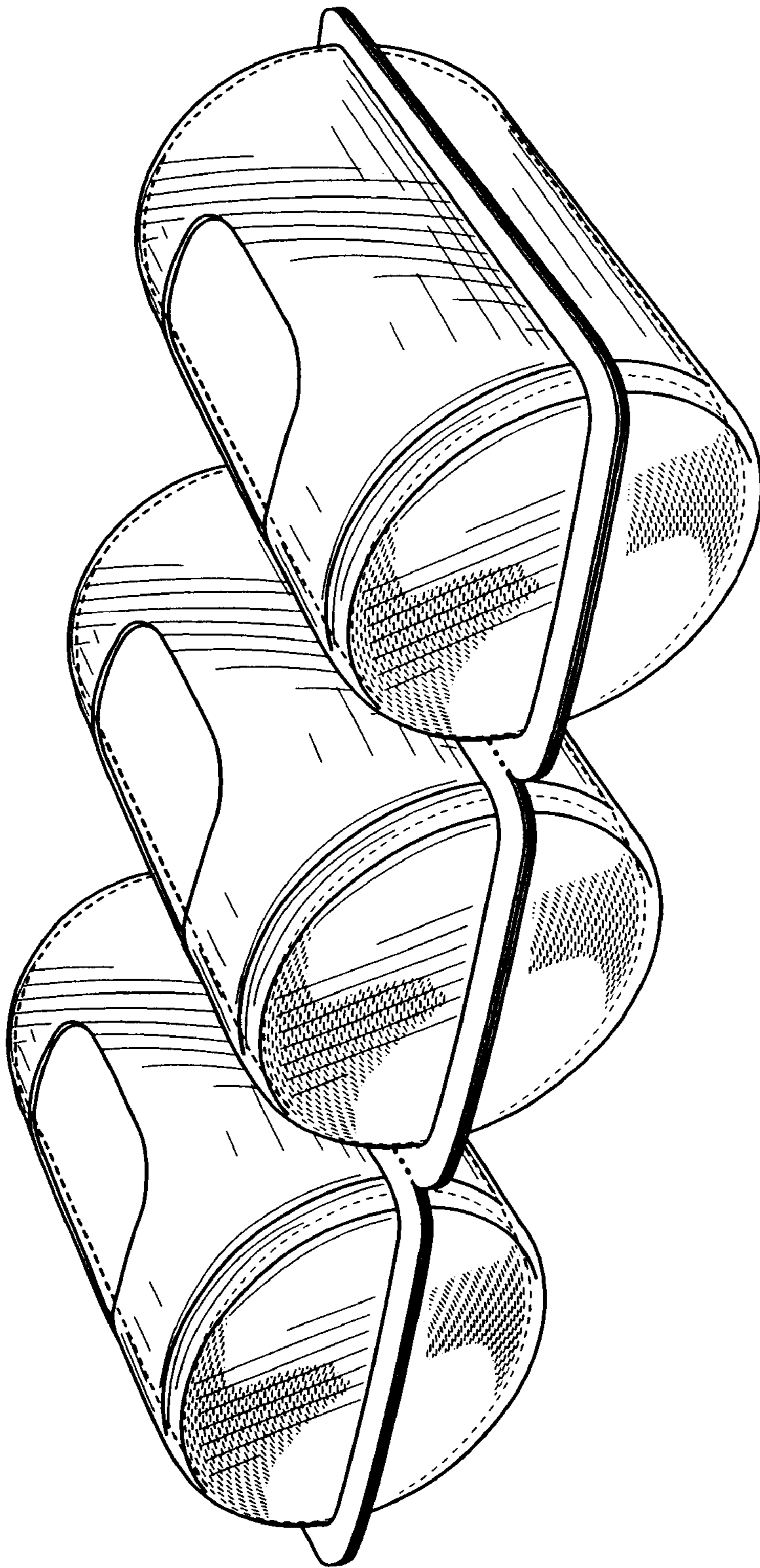

Fig. 1



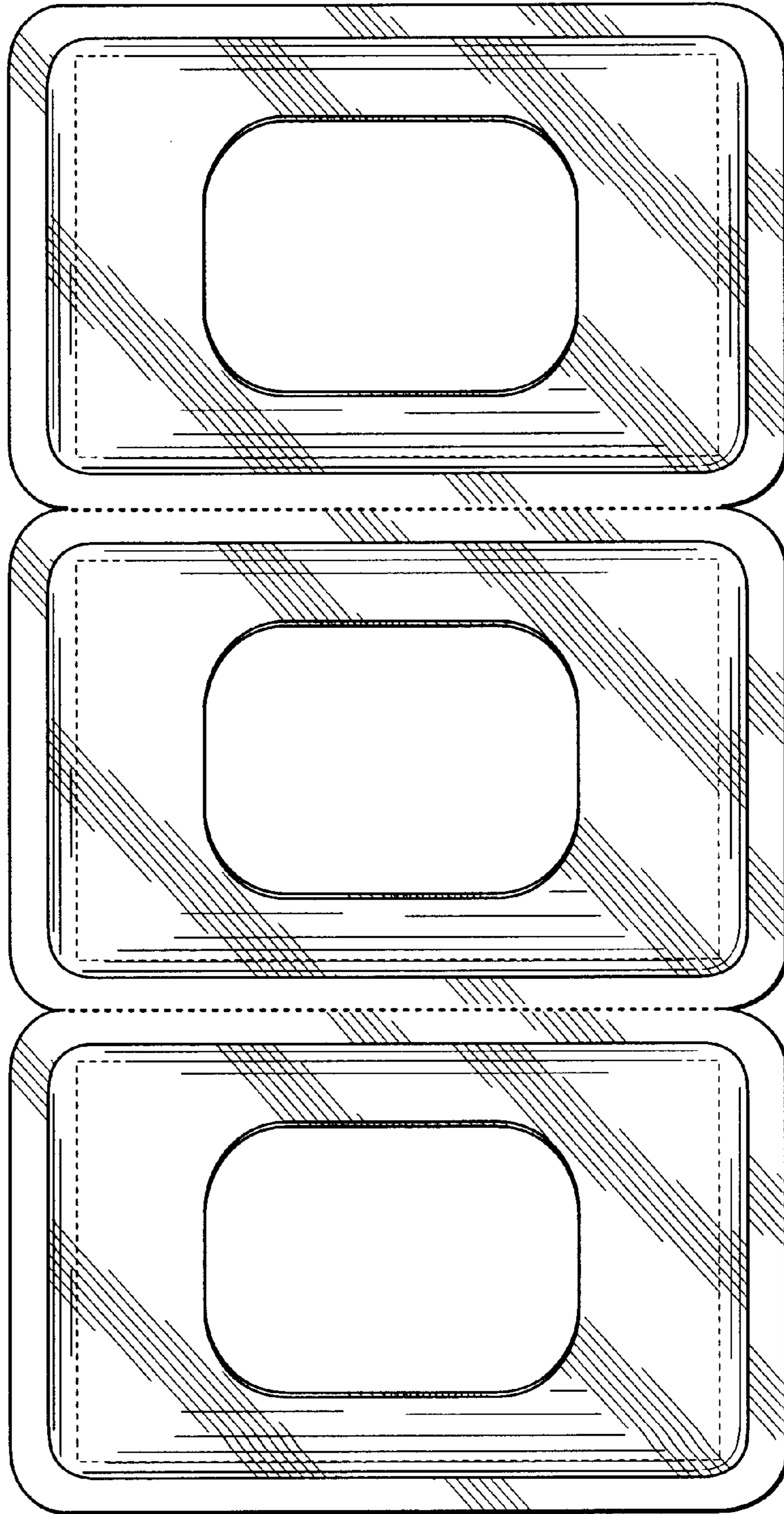

Fig. 2

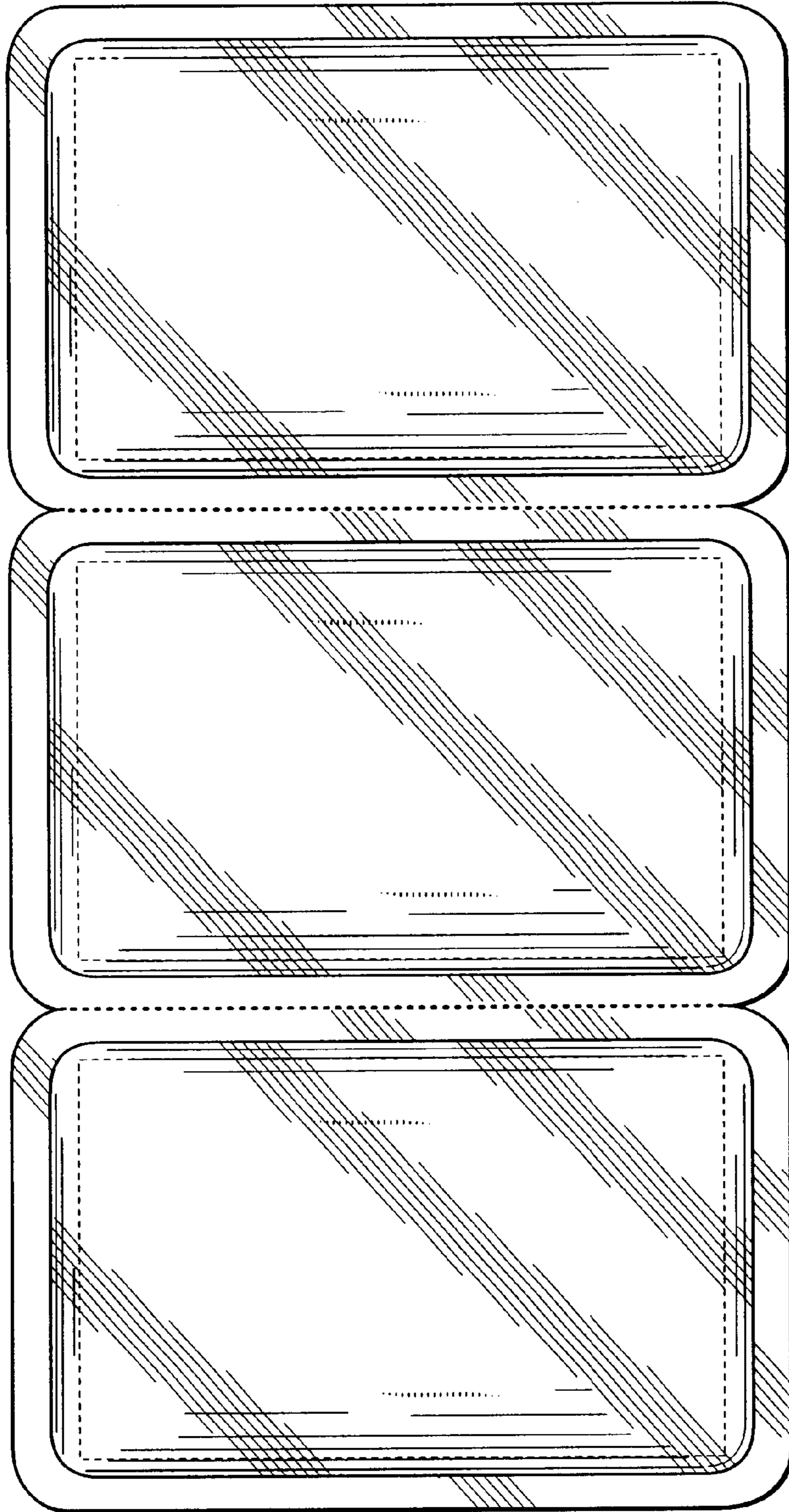
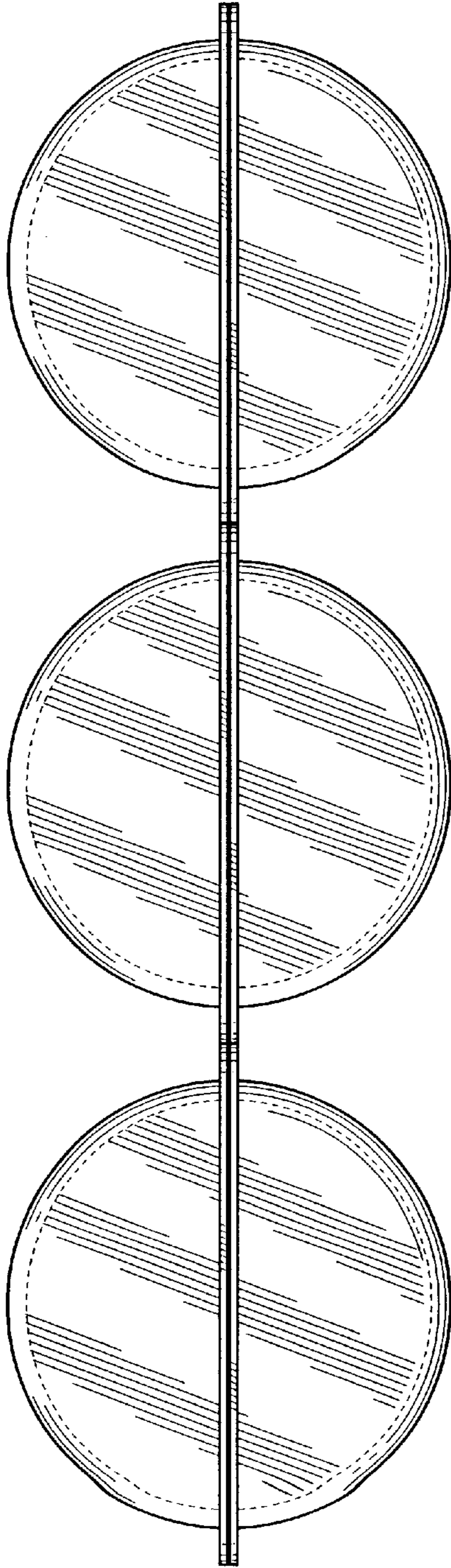
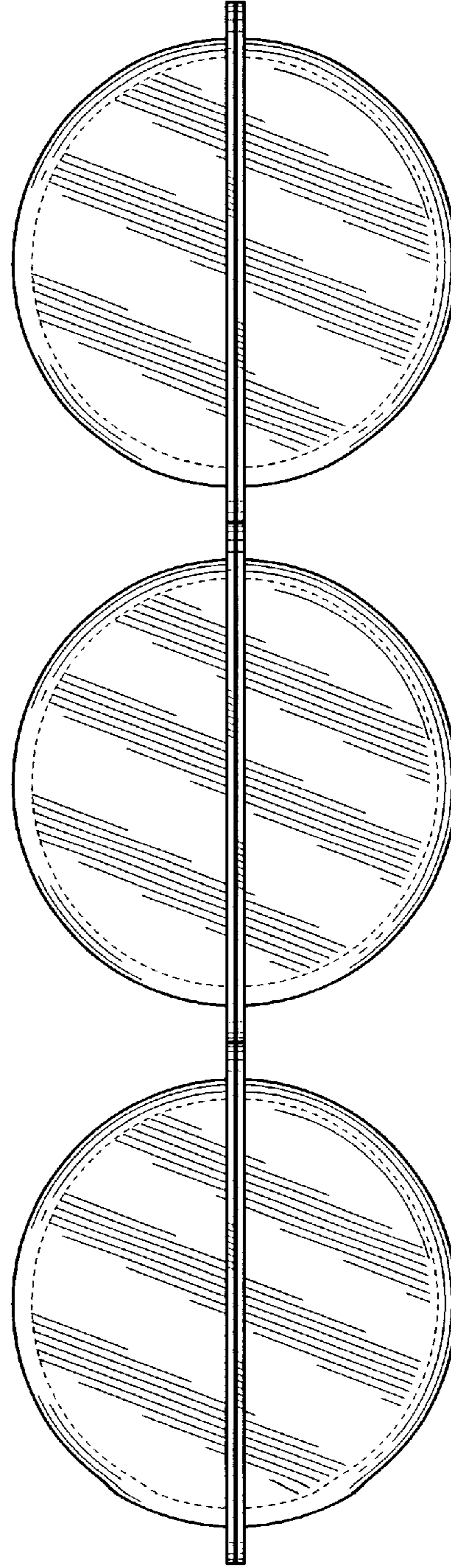

Fig. 3





**Fig. 4**



**Fig. 5**

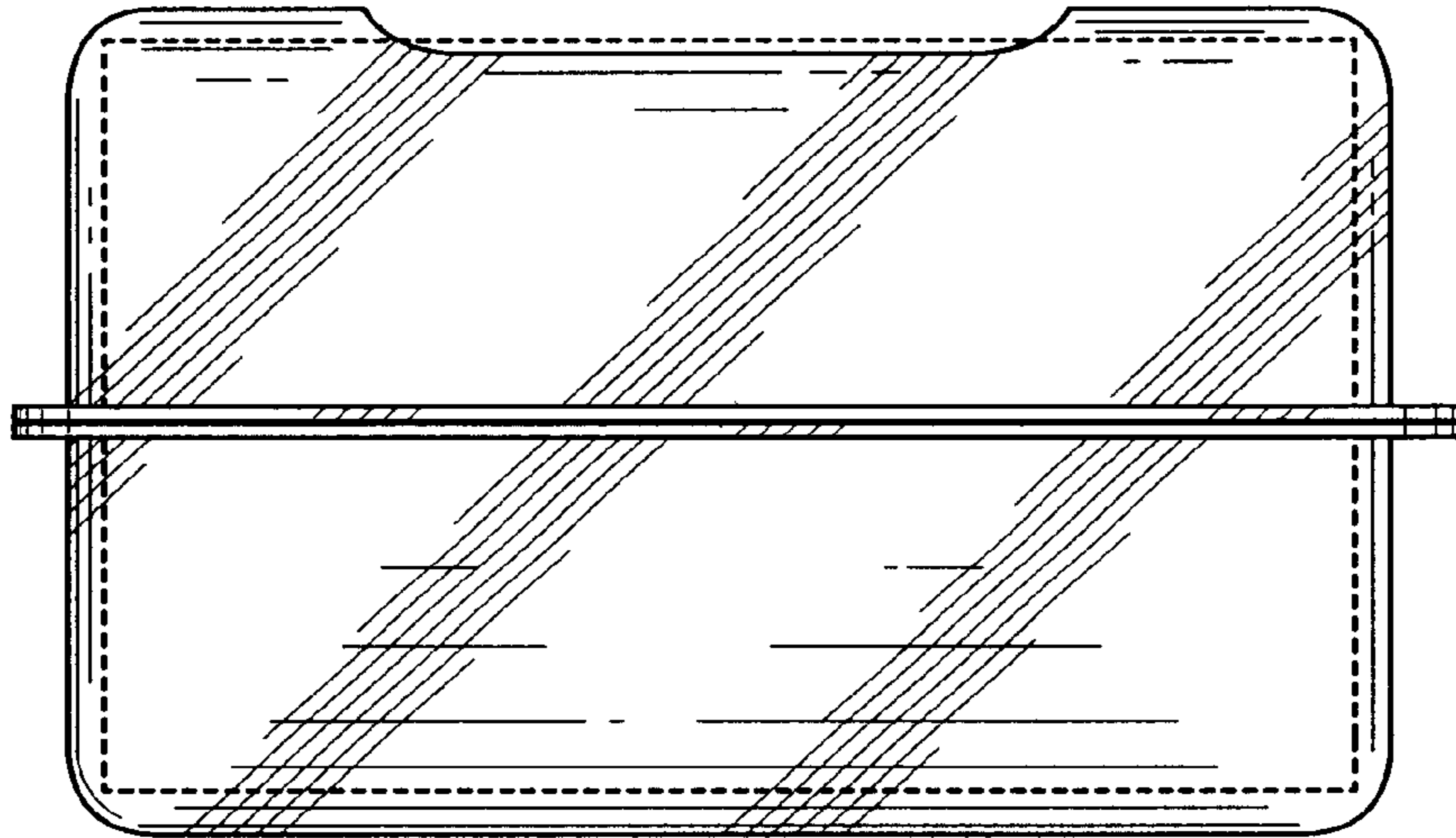

Fig. 6

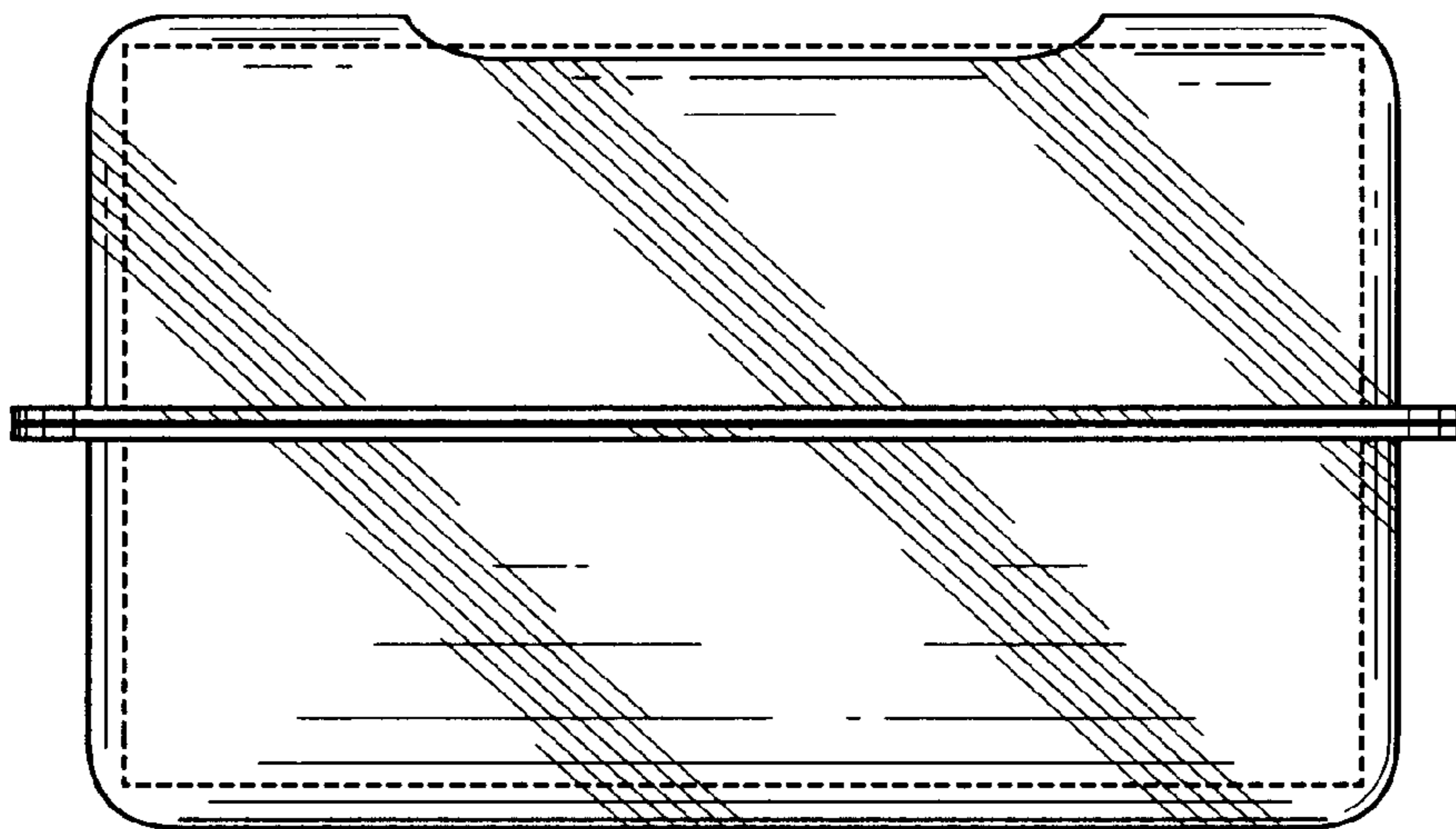

Fig. 7