



US00D533011S

(12) **United States Design Patent**
Pai

(10) **Patent No.: US D533,011 S**

(45) **Date of Patent: ** Dec. 5, 2006**

(54) **BARBECUE GRILL**

(76) Inventor: **Lucas Pai**, 19F.-1, No. 159, Sec. 1,
Chung-Kang Rd. West Dist., Taichung
City (TW)

(**) Term: **14 Years**

(21) Appl. No.: **29/223,368**

(22) Filed: **Feb. 14, 2005**

(51) **LOC (8) Cl. 07-02**

(52) **U.S. Cl. D7/334**

(58) **Field of Classification Search** D7/332-338,
D7/339-340, 347-348, 402-405; 99/339-340,
99/420, 421 A, 421 H, 421 M, 422, 423,
99/427, 443 C, 441, 443 R, 445, 447-448,
99/482, 450; 126/4, 9 R, 25 R, 25 A, 25 AA,
126/37 R, 37 B, 40, 41 R, 50, 276; D23/286
See application file for complete search history.

(56) **References Cited**

U.S. PATENT DOCUMENTS

D411,779 S * 7/1999 Husted D7/332
D461,359 S * 8/2002 Coleman et al. D7/334
D470,357 S * 2/2003 Home D7/334

D471,057 S * 3/2003 Chung D7/334
D489,222 S * 5/2004 Pai D7/334
D497,280 S * 10/2004 Pai D7/334
D499,928 S * 12/2004 Zhang D7/334
D501,116 S * 1/2005 Zhang D7/334
D503,065 S * 3/2005 Pai D7/334
D521,308 S * 5/2006 Tseng D7/334

* cited by examiner

Primary Examiner—Ruth McInroy

(74) *Attorney, Agent, or Firm*—Egbert Law Offices

(57) **CLAIM**

I claim the ornamental design for a barbecue grill, as shown and described.

DESCRIPTION

FIG. 1 is an upper perspective view of the barbecue grill showing my design.

FIG. 2 is a front view thereof;

FIG. 3 is a back view thereof;

FIG. 4 is a side view thereof;

FIG. 5 is an opposite side view thereof;

FIG. 6 is a top view thereof; and,

FIG. 7 is a bottom view thereof.

1 Claim, 4 Drawing Sheets

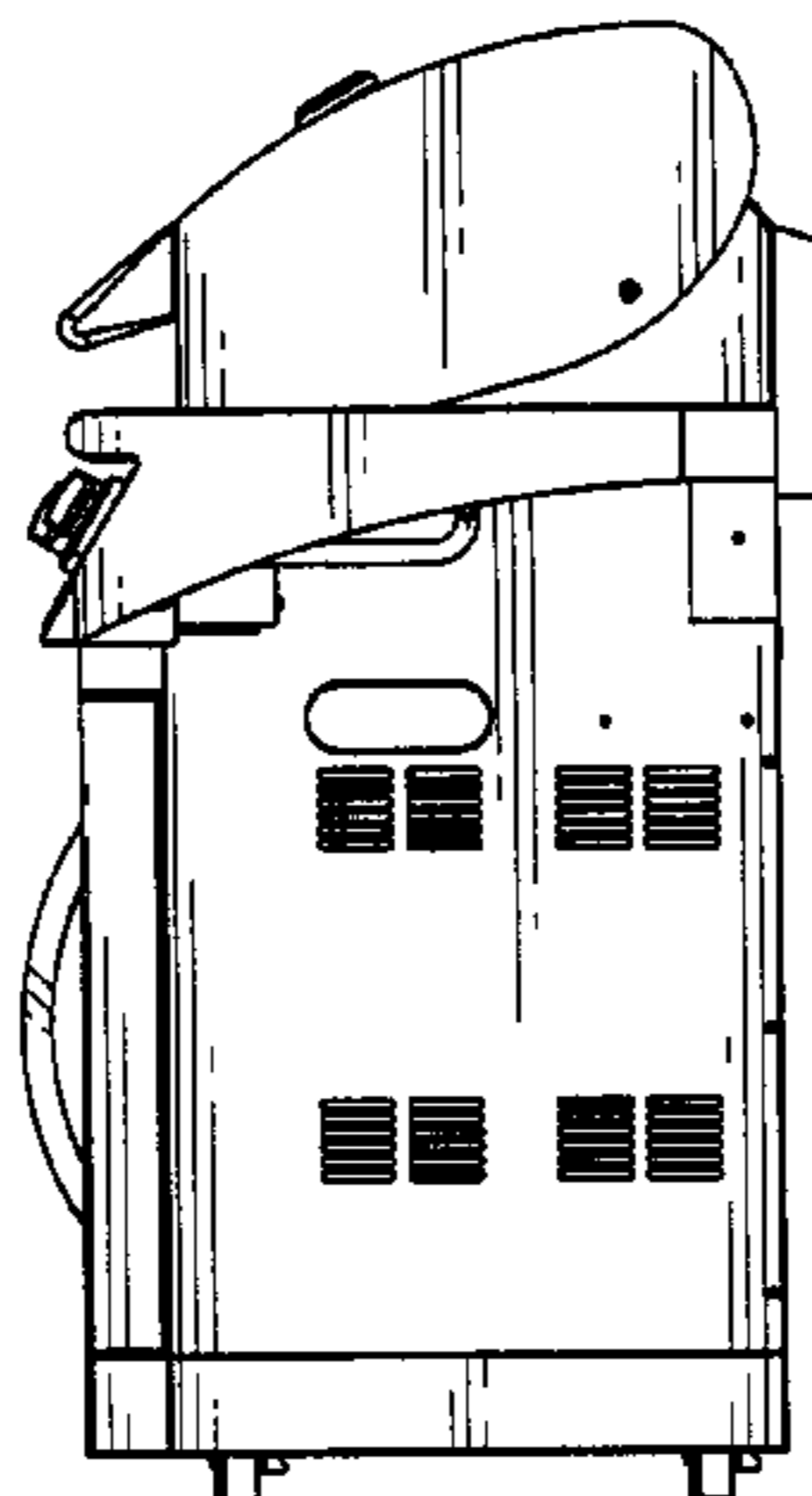
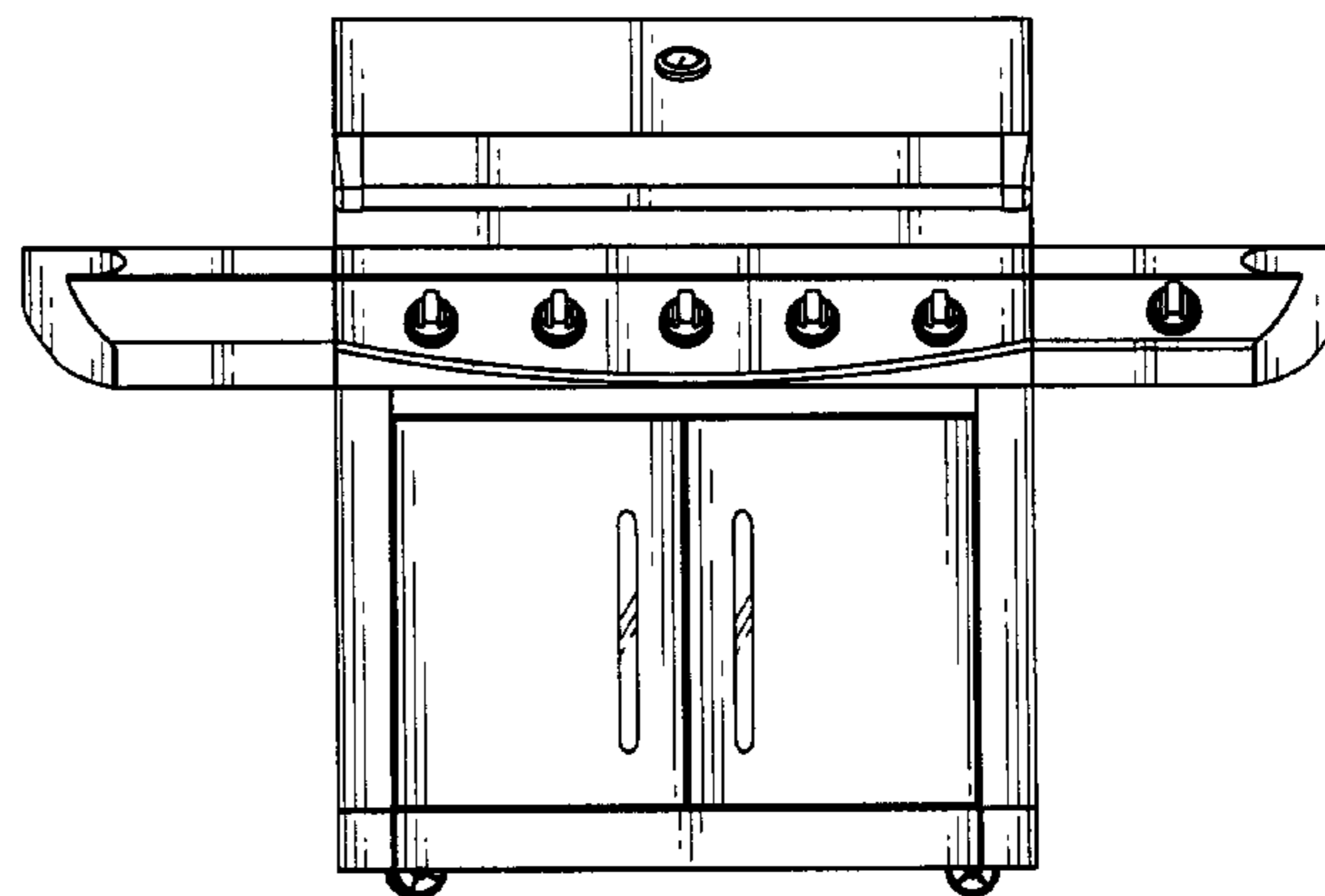
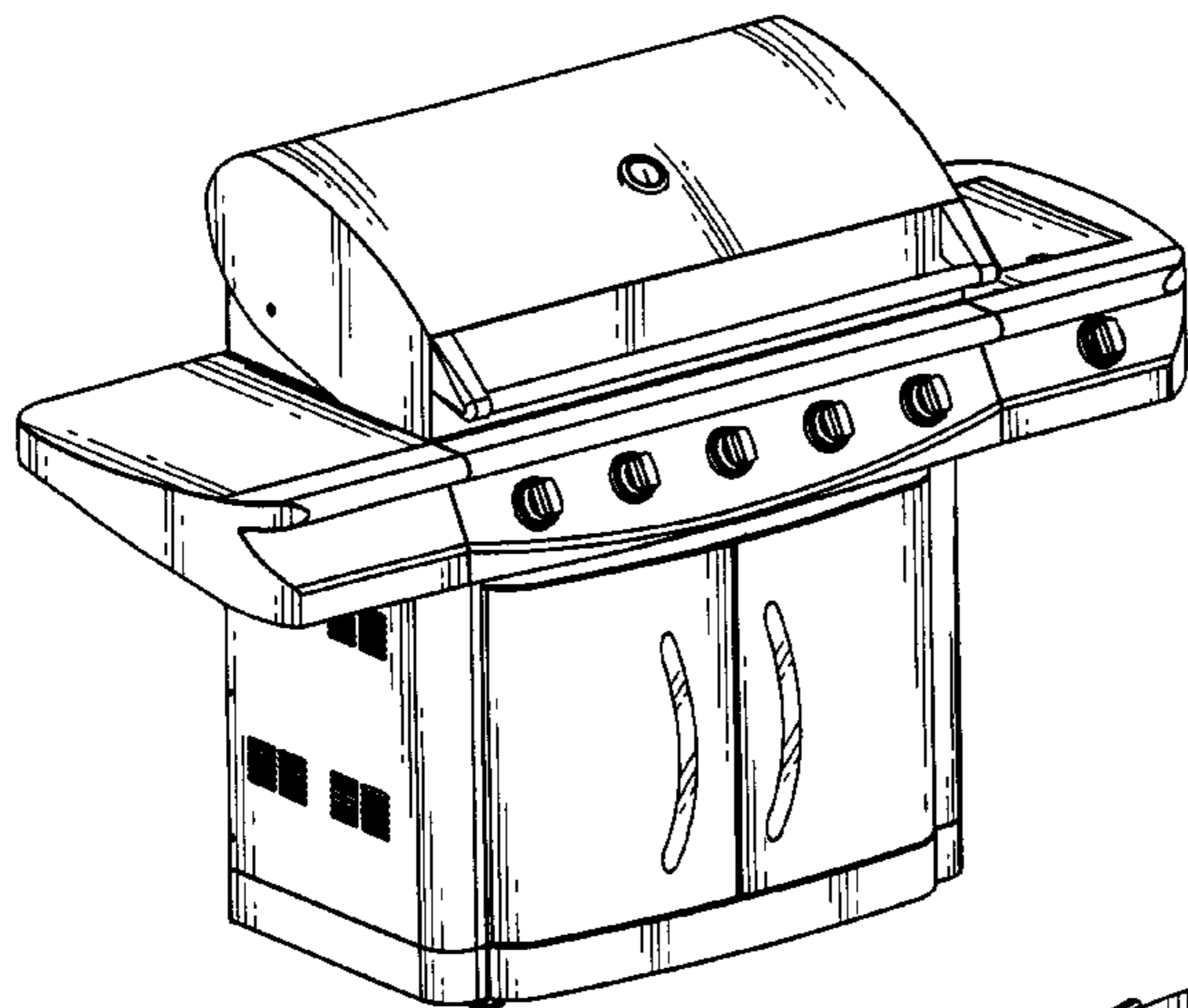

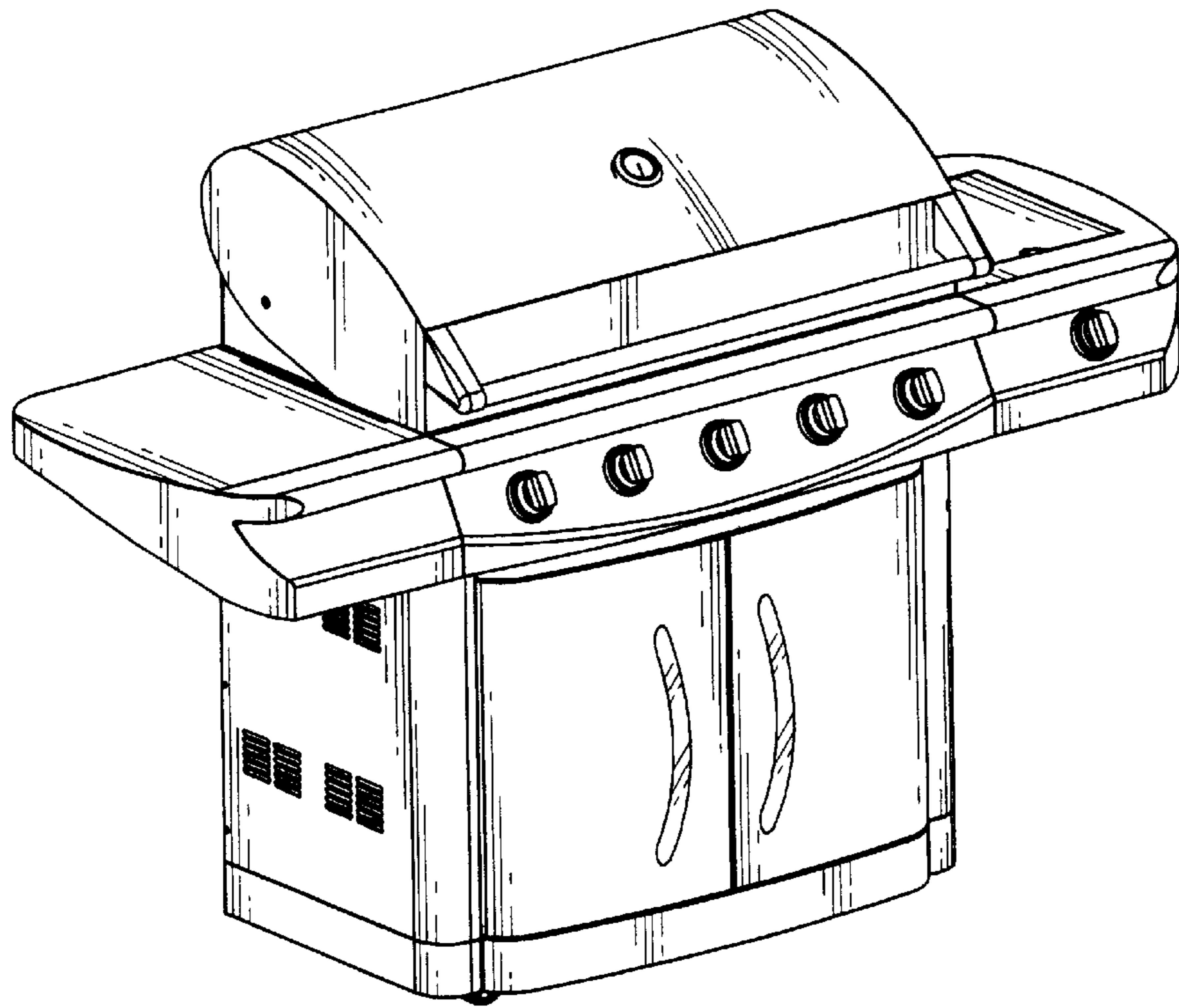

FIG.1

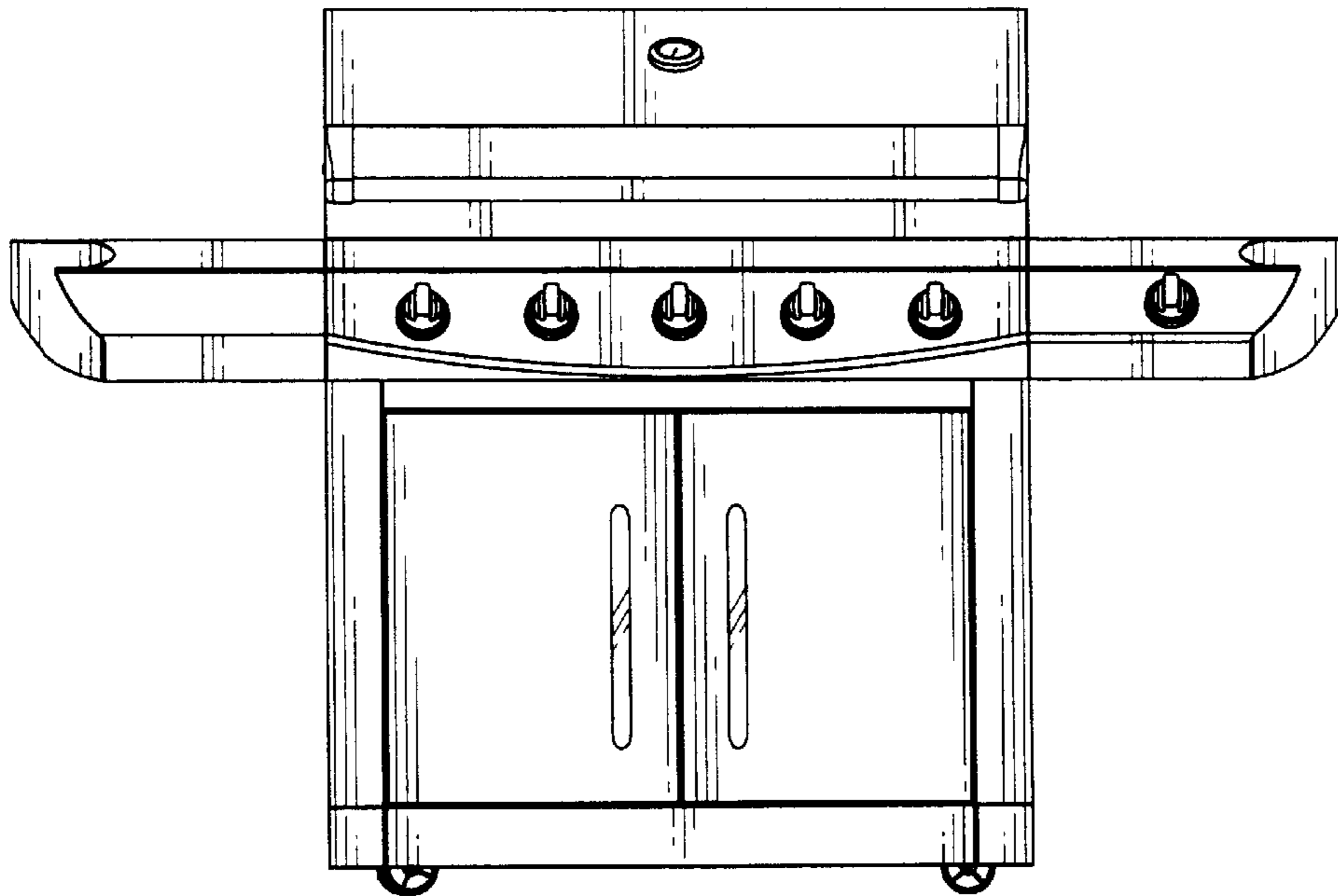

FIG. 2

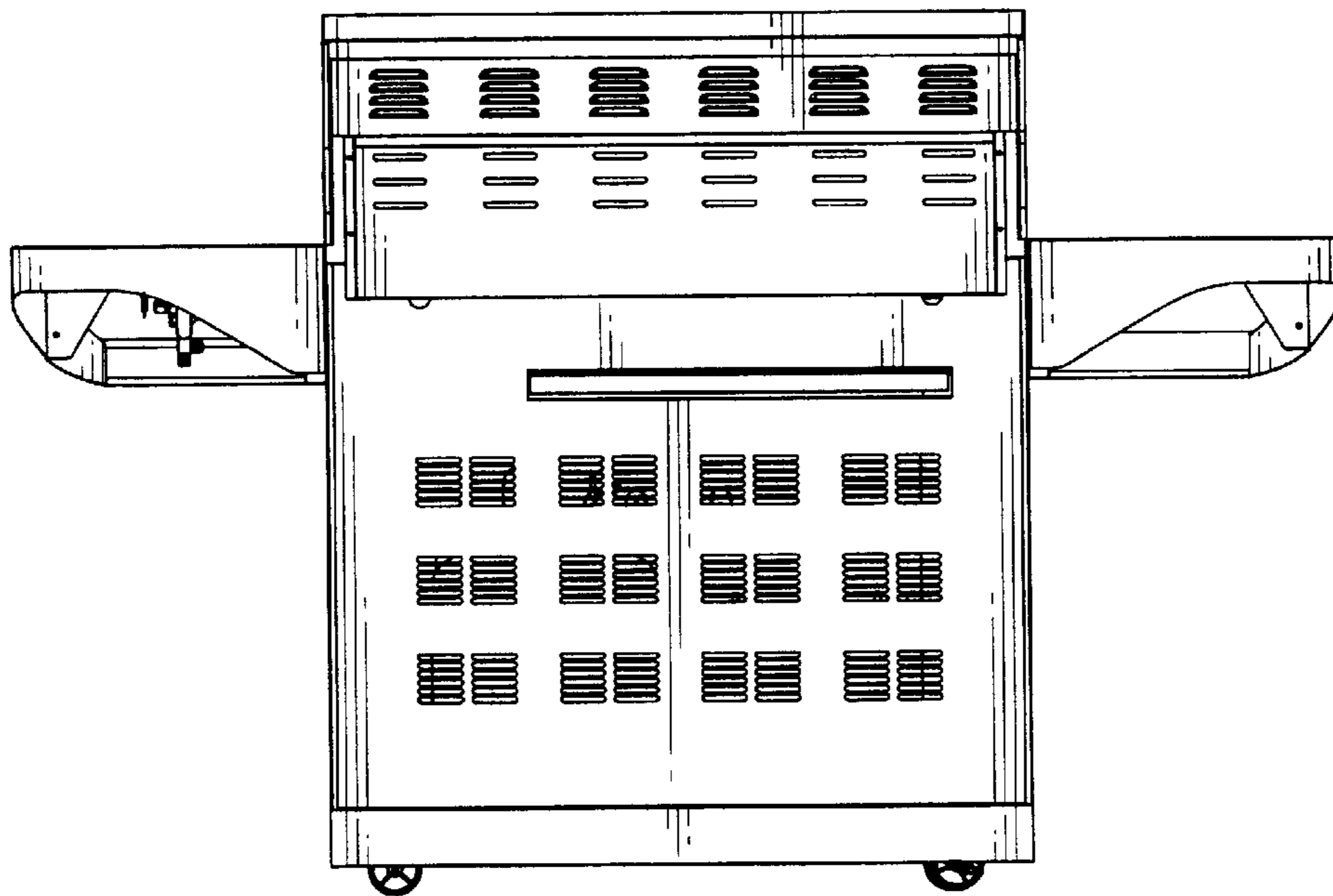

FIG. 3

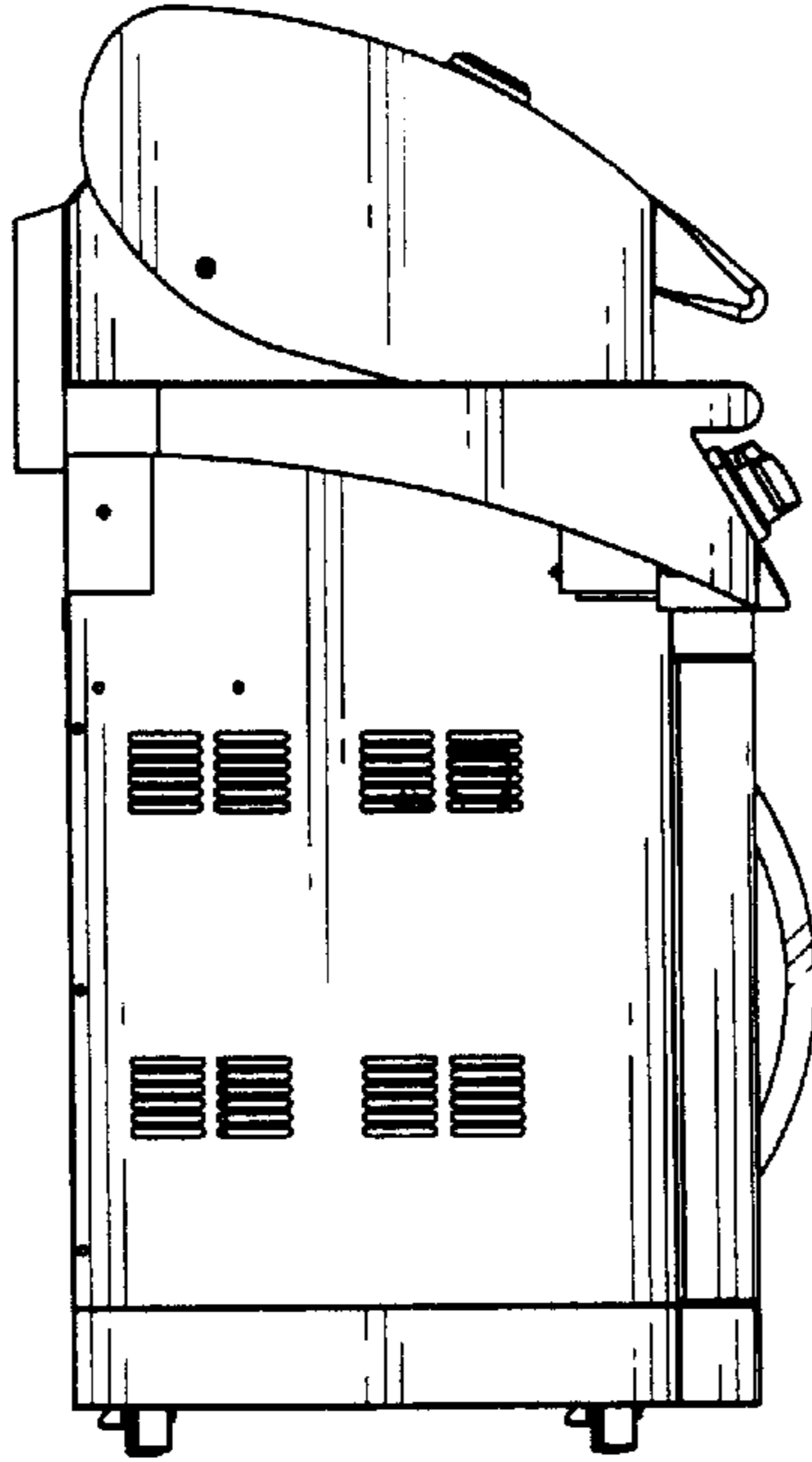

FIG. 4

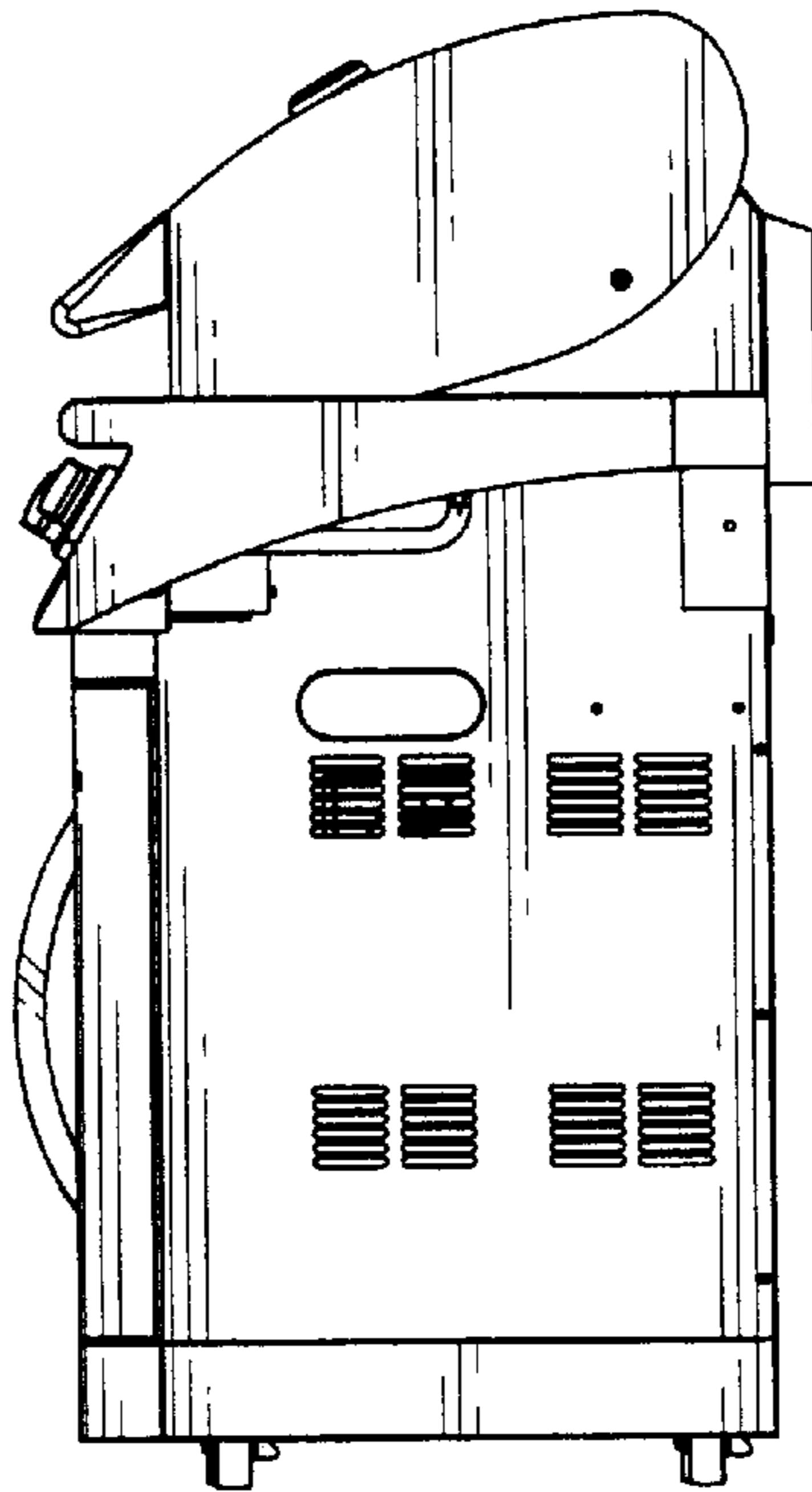

FIG. 5

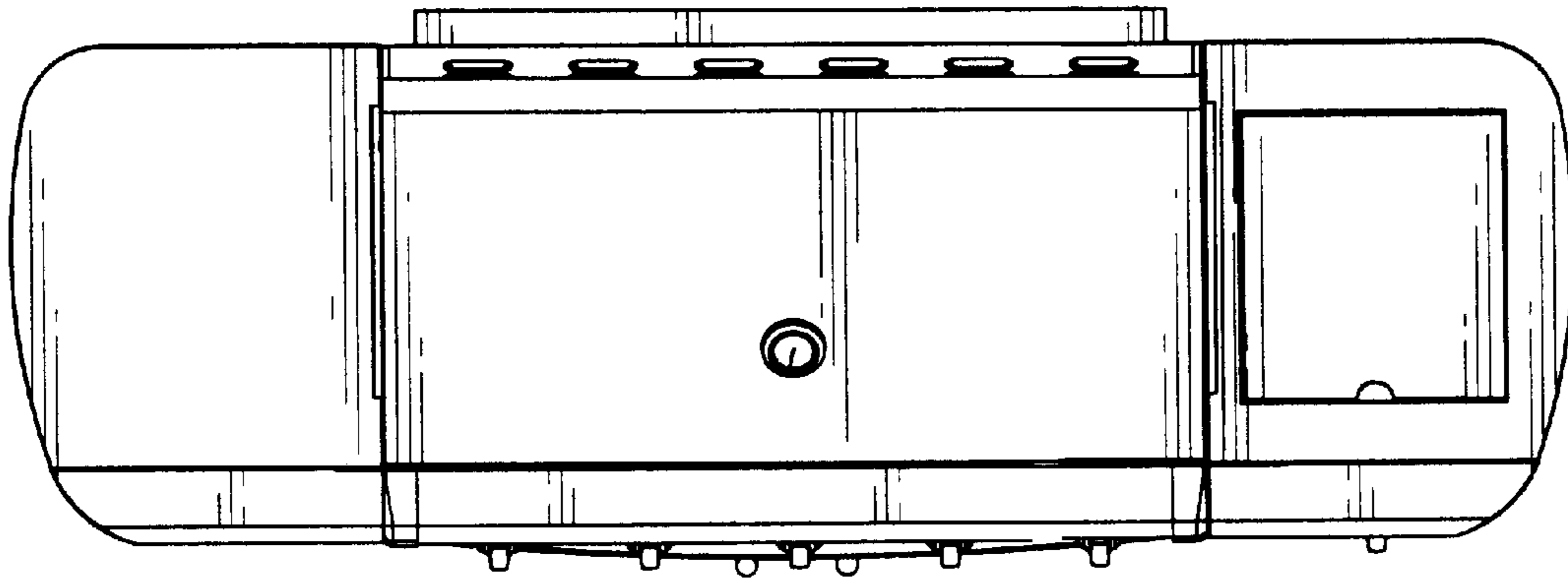

FIG. 6

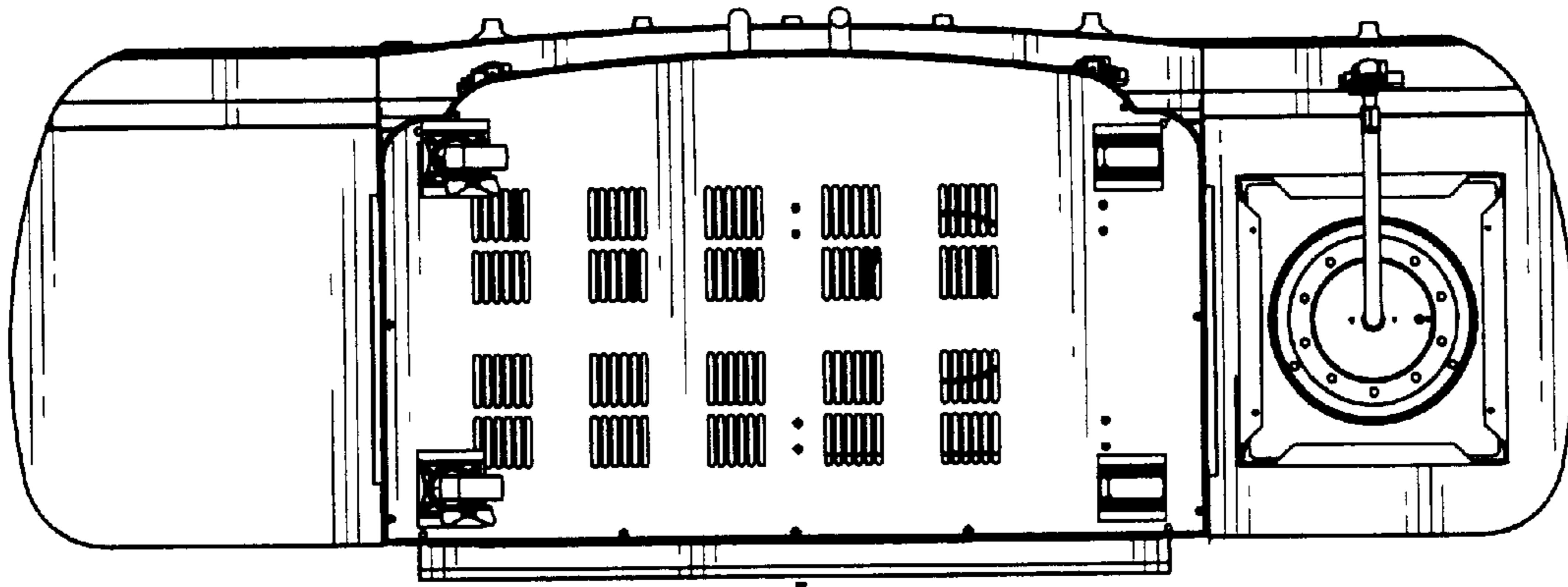

FIG. 7