



US00D532985S

(12) **United States Design Patent** (10) **Patent No.:** **US D532,985 S**
Mitjans (45) **Date of Patent:** **** Dec. 5, 2006**

(54) **SEATS**

(75) Inventor: **Jose Figueras Mitjans**, Barcelona (ES)

(73) Assignee: **Figueras International Seating, S.A.**,
Barcelona (ES)

(**) Term: **14 Years**

(21) Appl. No.: **29/210,417**

(22) Filed: **Jul. 30, 2004**

(30) **Foreign Application Priority Data**

Jan. 30, 2004 (EM) 000133962

(51) **LOC (8) Cl.** **06-01**

(52) **U.S. Cl.** **D6/368**

(58) **Field of Classification Search** D6/334,
D6/335, 336, 356, 364, 365, 367, 368, 371-374,
D6/381, 500-502; 297/232, 248, 311, 324,
297/326, 332, 335, 411.45, 451.5, 354.1,
297/217.3, 302.4

See application file for complete search history.

(56) **References Cited**

U.S. PATENT DOCUMENTS

141,457	A	*	8/1873	Nolan	297/331
D226,058	S	*	1/1973	Woods	D6/368
D370,791	S	*	6/1996	Yamazaki	D6/368
5,678,889	A	*	10/1997	Purcell, Jr.	297/232
5,918,937	A	*	7/1999	Moffa et al.	297/324
D412,622	S	*	8/1999	DeJule	D6/371
D439,428	S	*	3/2001	Mizuno	D6/368
D440,422	S	*	4/2001	DeJule	D6/371
D441,972	S	*	5/2001	Mitjans	D6/368
D447,642	S	*	9/2001	Kimura	D6/368
6,820,932	B1	*	11/2004	Misthos et al.	297/232
D509,672	S	*	9/2005	Nemeth et al.	D6/368
2004/0164597	A1	*	8/2004	Olarte	297/335

* cited by examiner

Primary Examiner—Mimosa De

(74) *Attorney, Agent, or Firm*—Dennis G. LaPointe

(57) **CLAIM**

I claim the ornamental design for seats, as shown and described.

DESCRIPTION

FIG. 1 is a frontal perspective view of a first embodiment of my new design depicting a left side seat cushion and an arm rest in a raised position;

FIG. 2 is a rear side perspective view thereof;

FIG. 3 is a front elevation view thereof;

FIG. 4 is a left side elevation view thereof;

FIG. 5 is a rear view elevation view thereof;

FIG. 6 is a top plan view thereof; and

FIG. 7 is a bottom plan view thereof;

FIG. 8 is a frontal perspective view of a second embodiment of my new design depicting a left side seat cushion and an arm rest in a raised position;

FIG. 9 is a rear side perspective view of thereof;

FIG. 10 is a front elevation view thereof;

FIG. 11 is a left side elevation view thereof;

FIG. 12 is a rear view elevation view thereof;

FIG. 13 is a top plan view thereof; and

FIG. 14 is a bottom plan view thereof;

FIG. 15 is a frontal perspective view of a third embodiment of my new design depicting a left side seat cushion and an arm rest in a raised position;

FIG. 16 is a rear side perspective view of thereof;

FIG. 17 is a front elevation view thereof;

FIG. 18 is a left side elevation view thereof;

FIG. 19 is a rear view elevation view thereof;

FIG. 20 is a top plan view thereof; and,

FIG. 21 is a bottom plan view thereof.

1 Claim, 11 Drawing Sheets

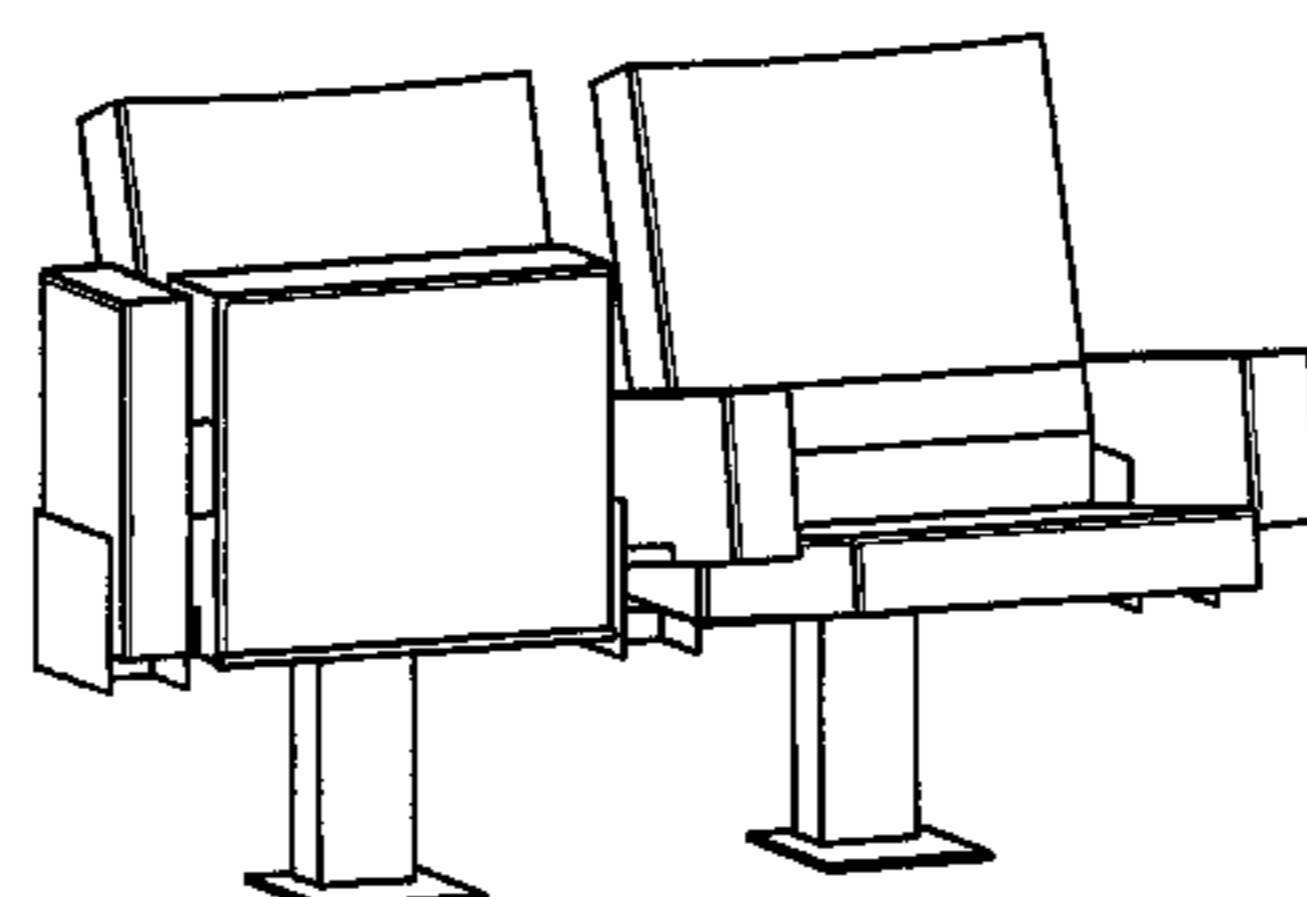
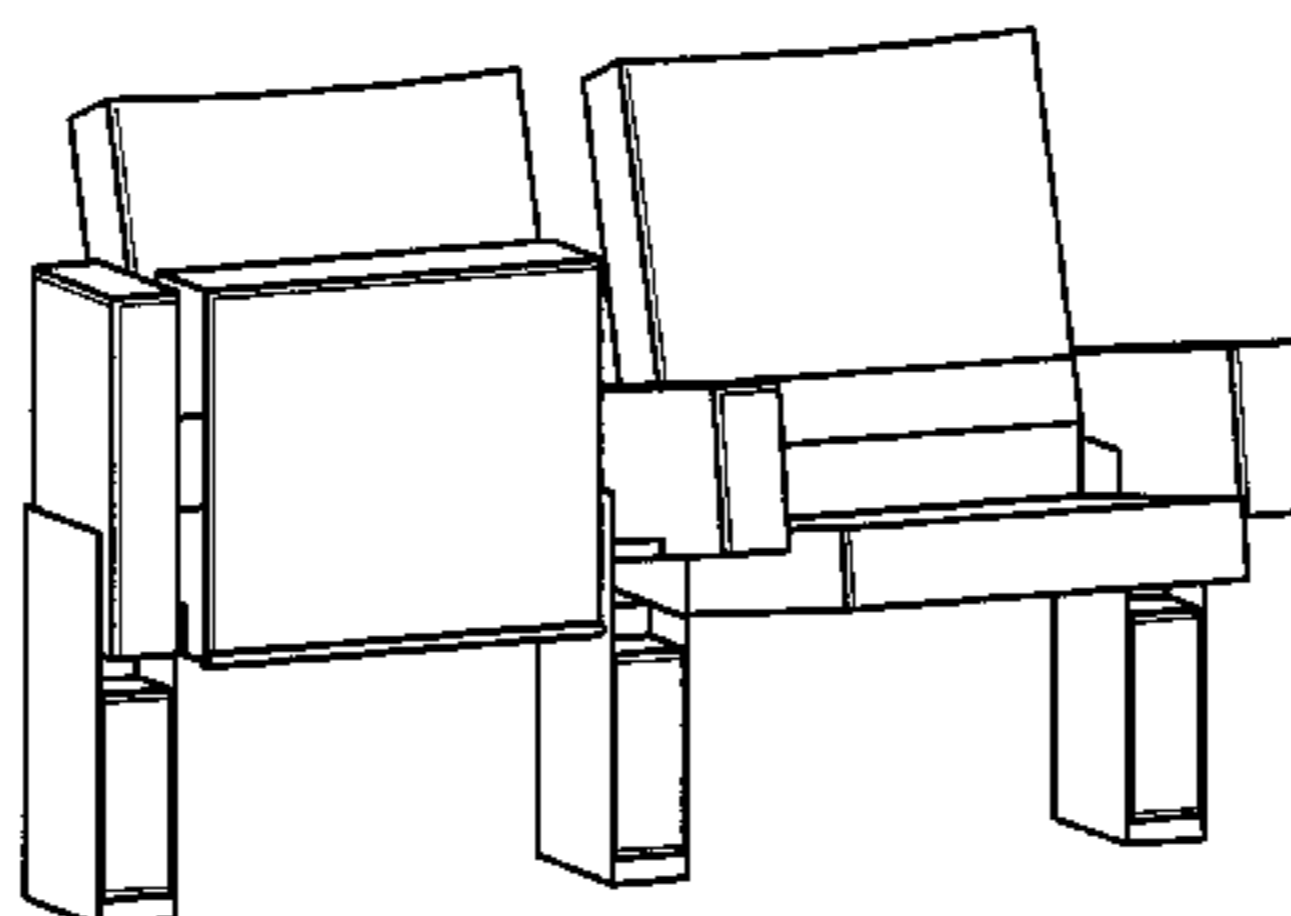

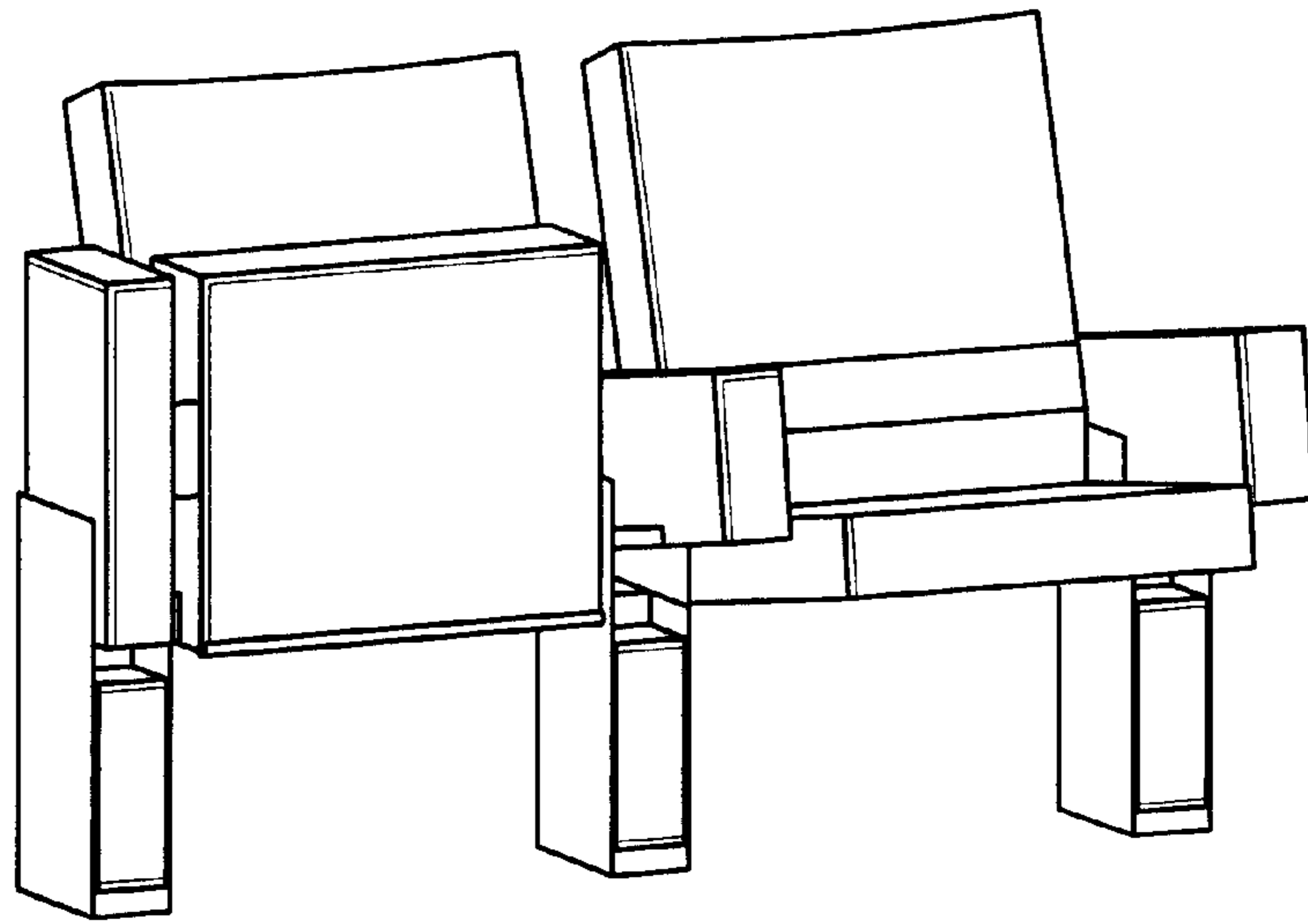

Fig. 1

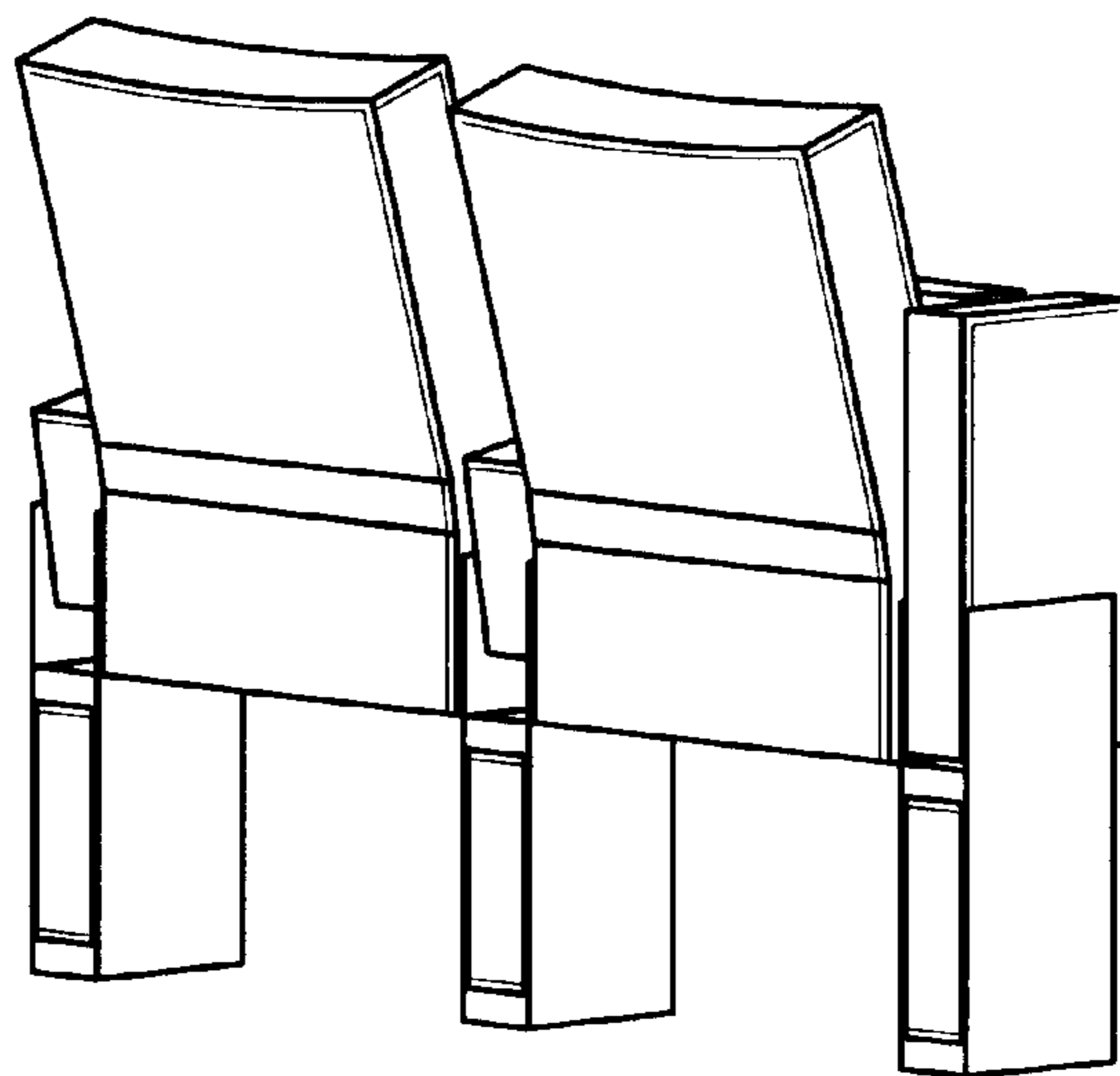

Fig. 2

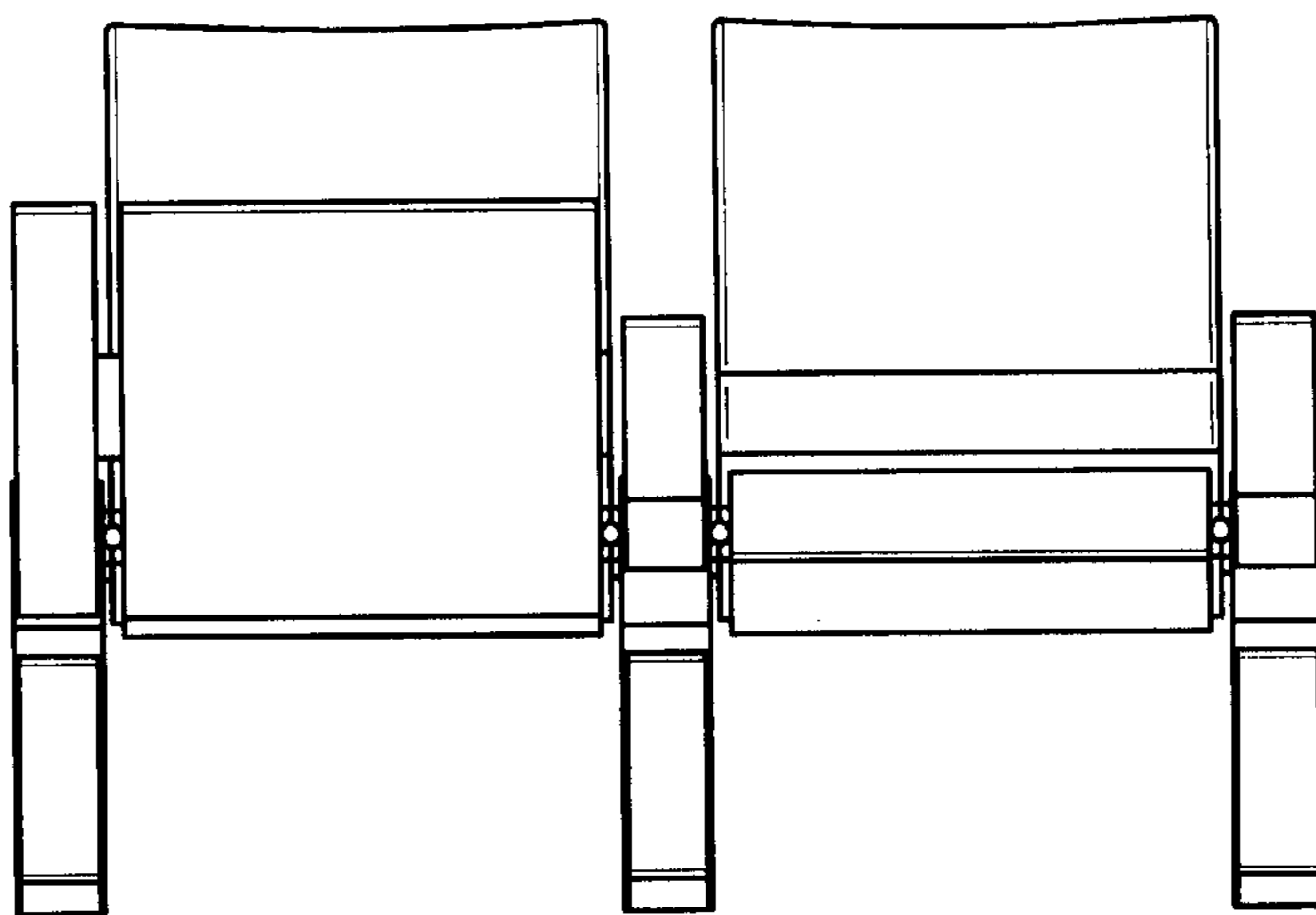

Fig. 3

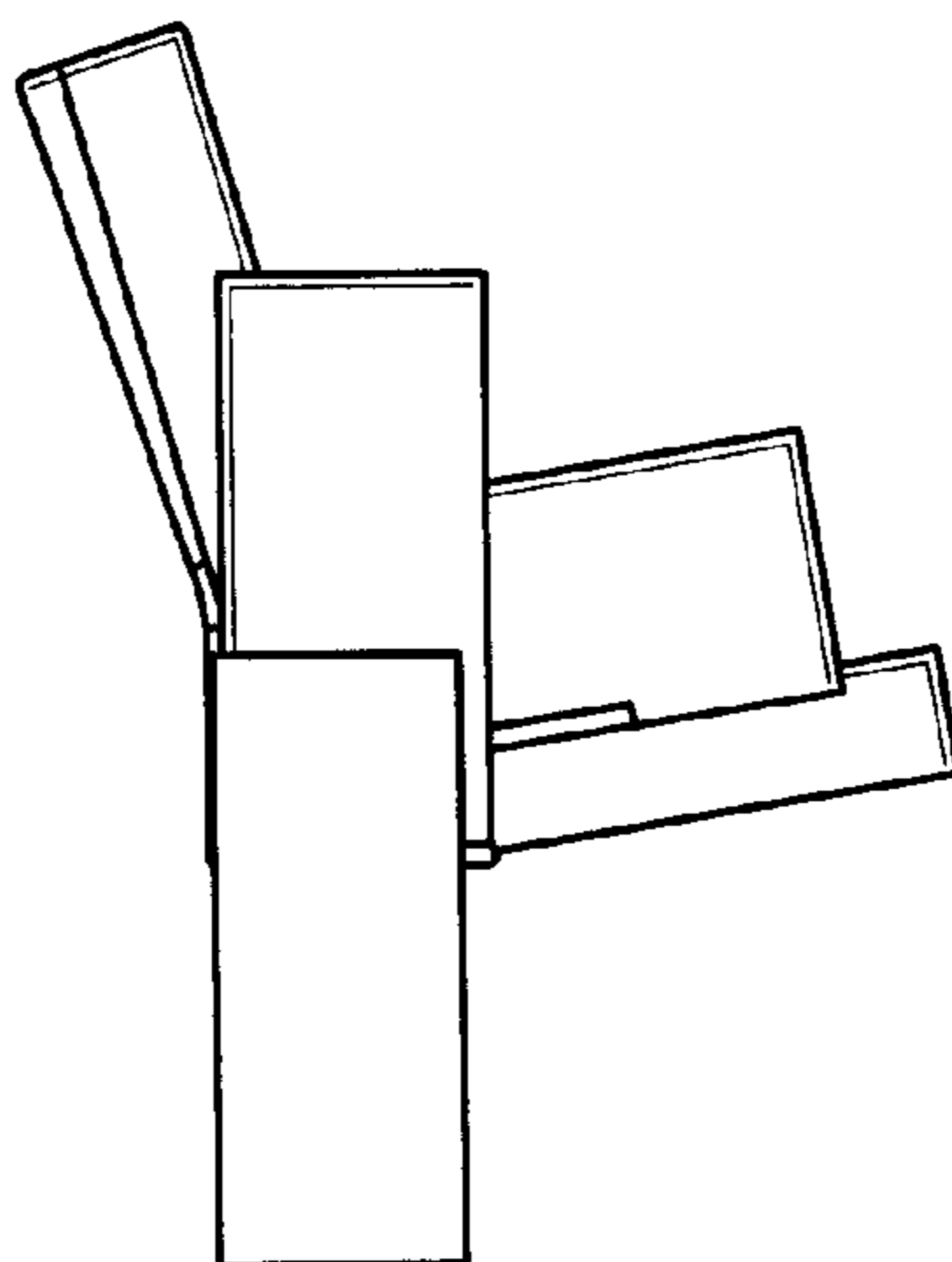

Fig. 4

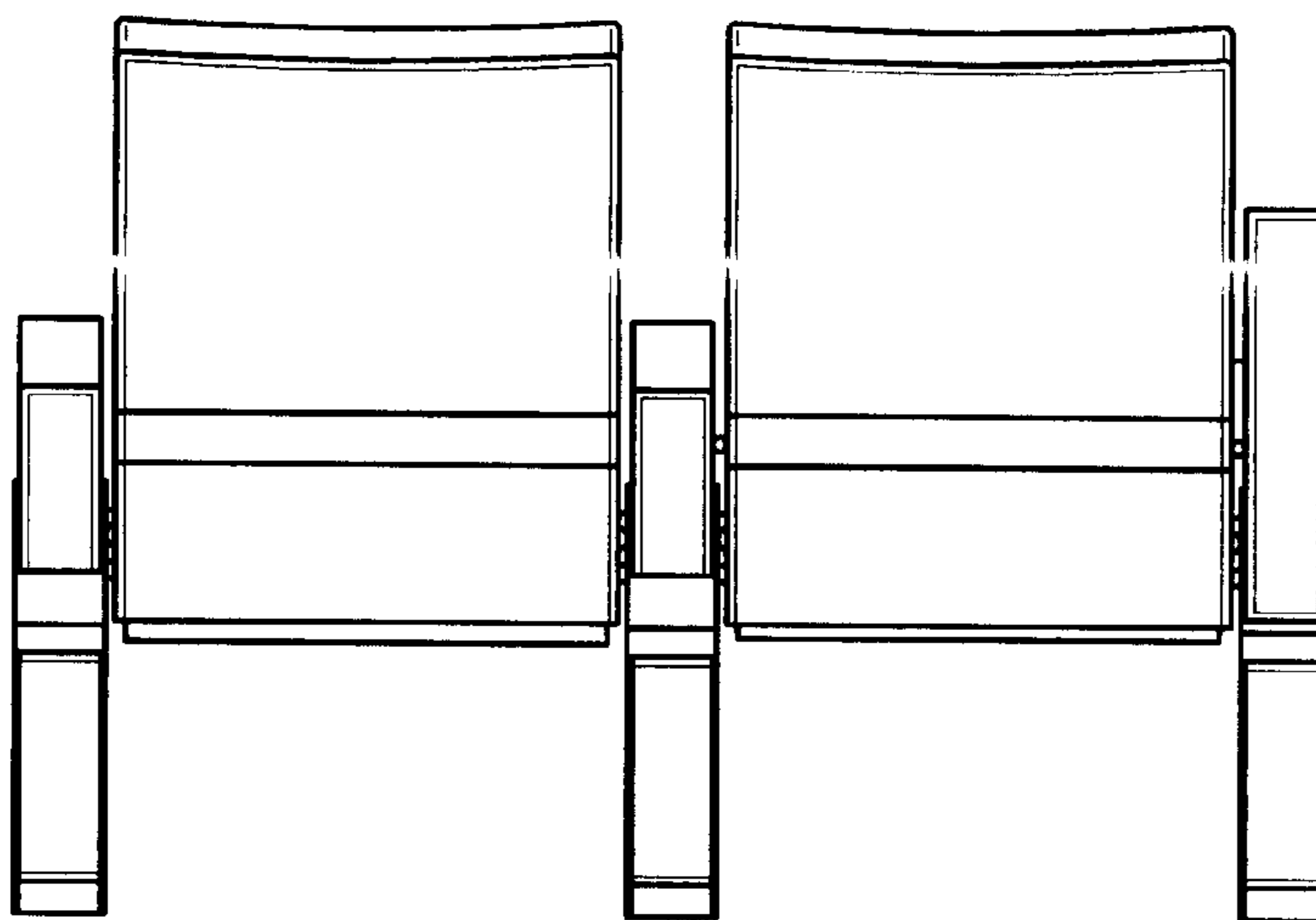

Fig. 5

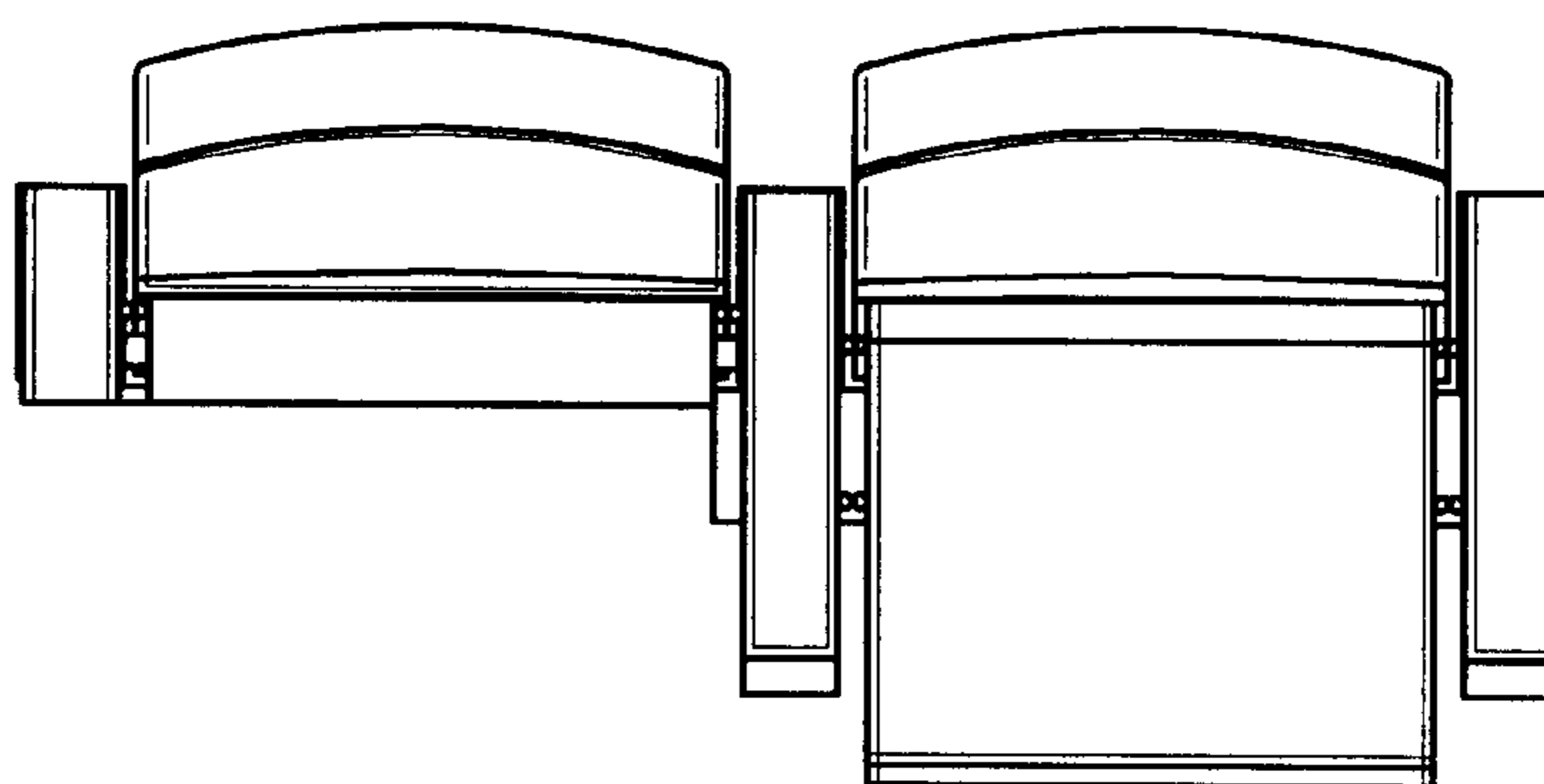

Fig. 6

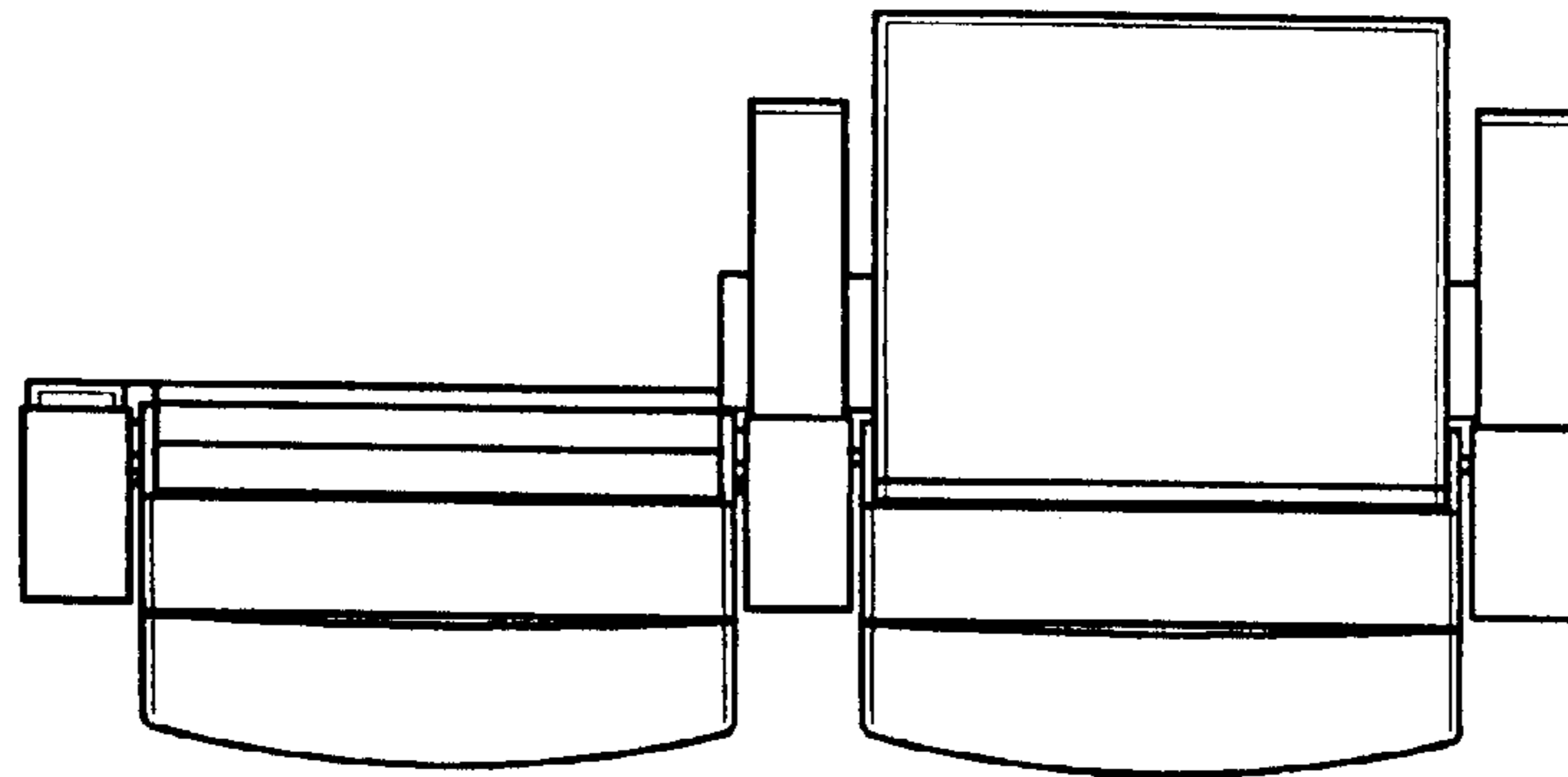

Fig. 7

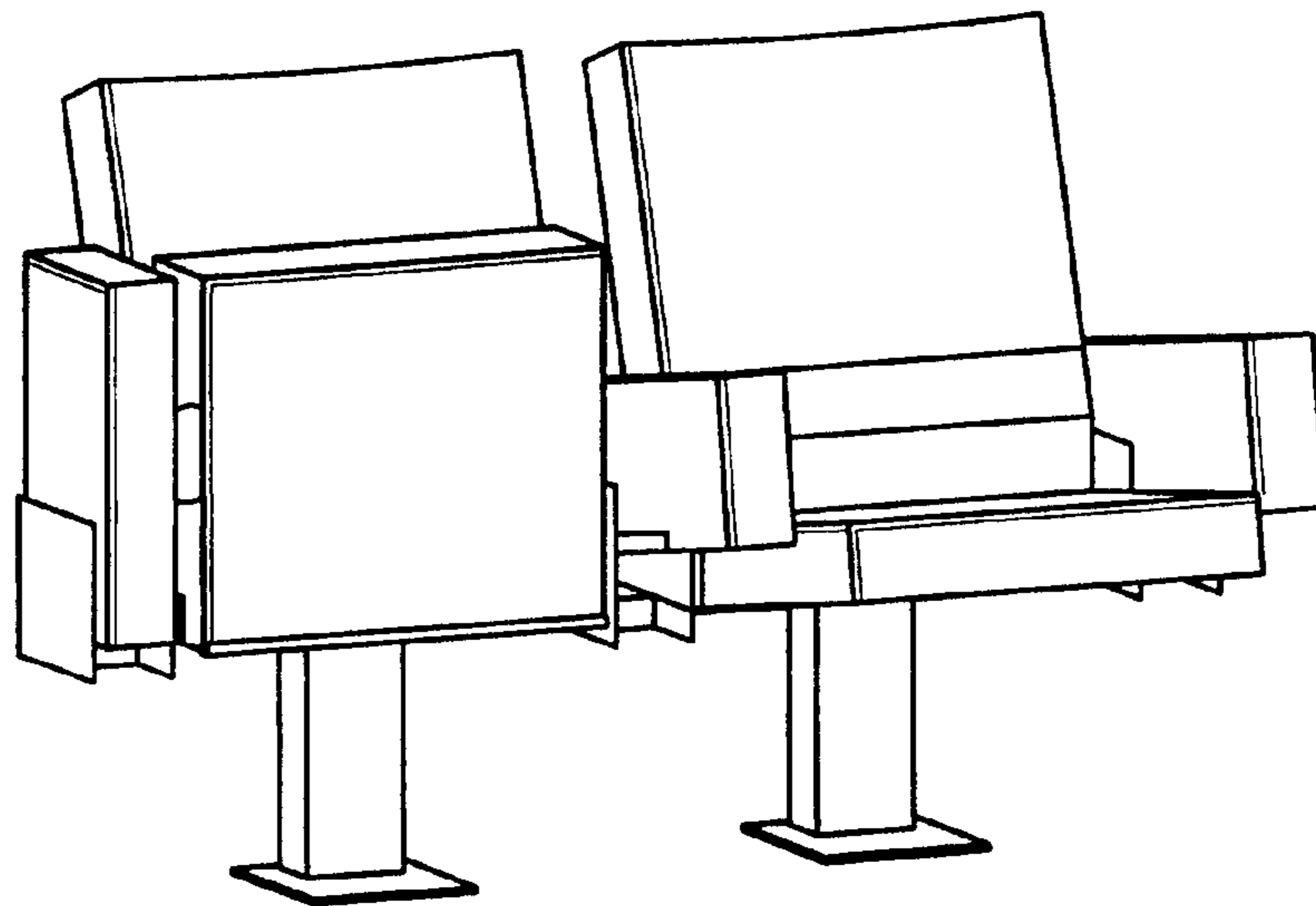

Fig. 8

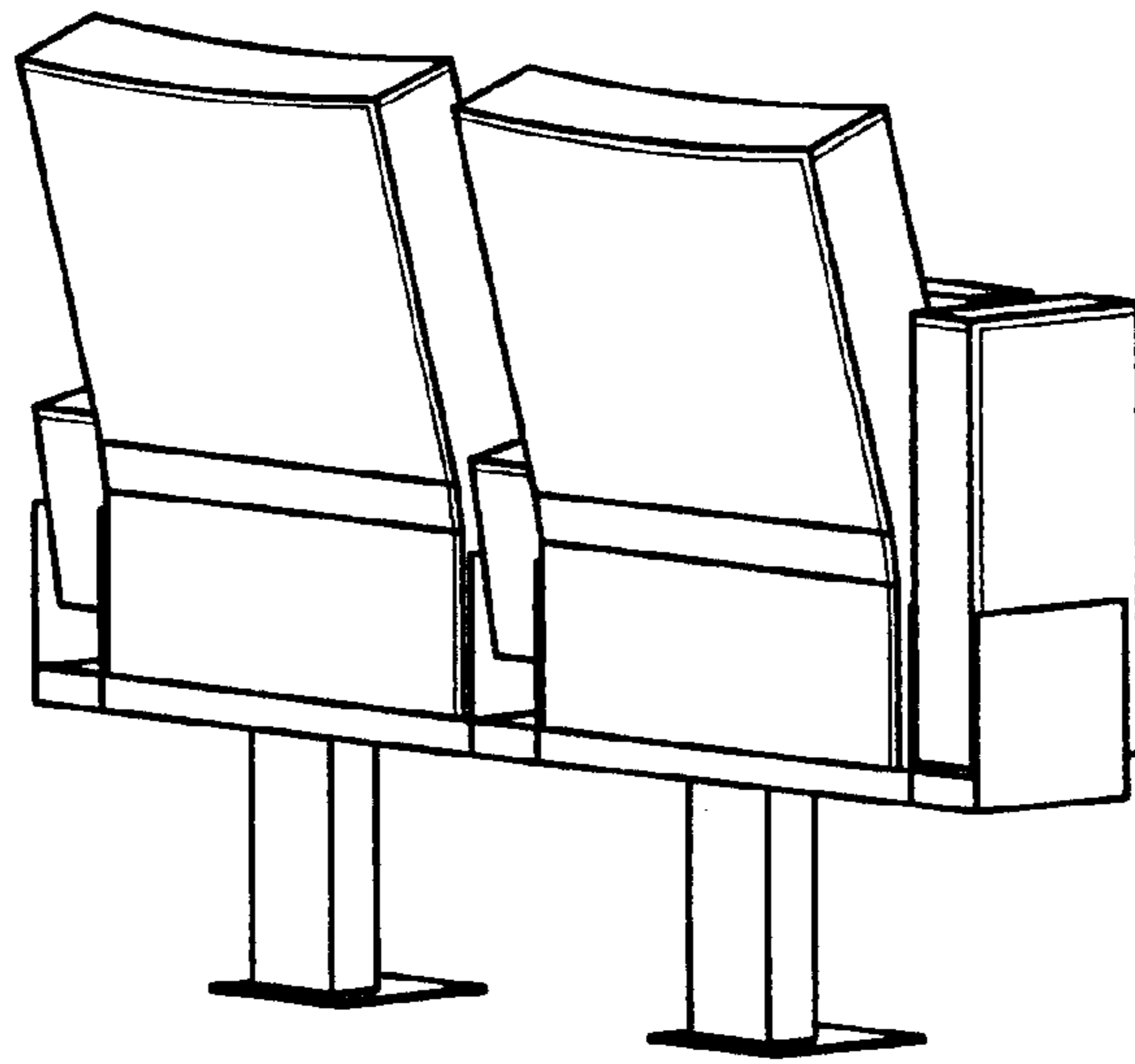

Fig. 9

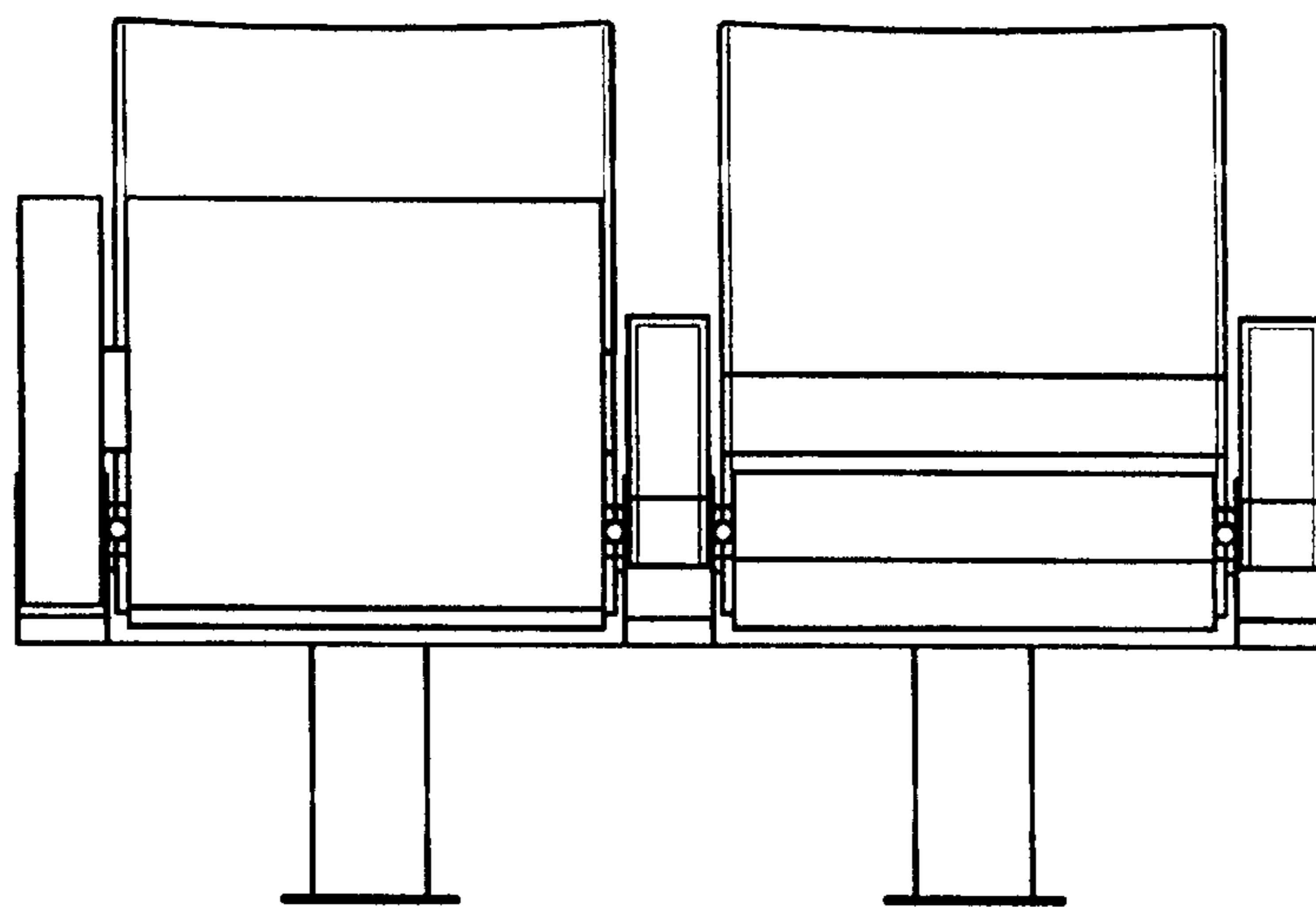

Fig. 10

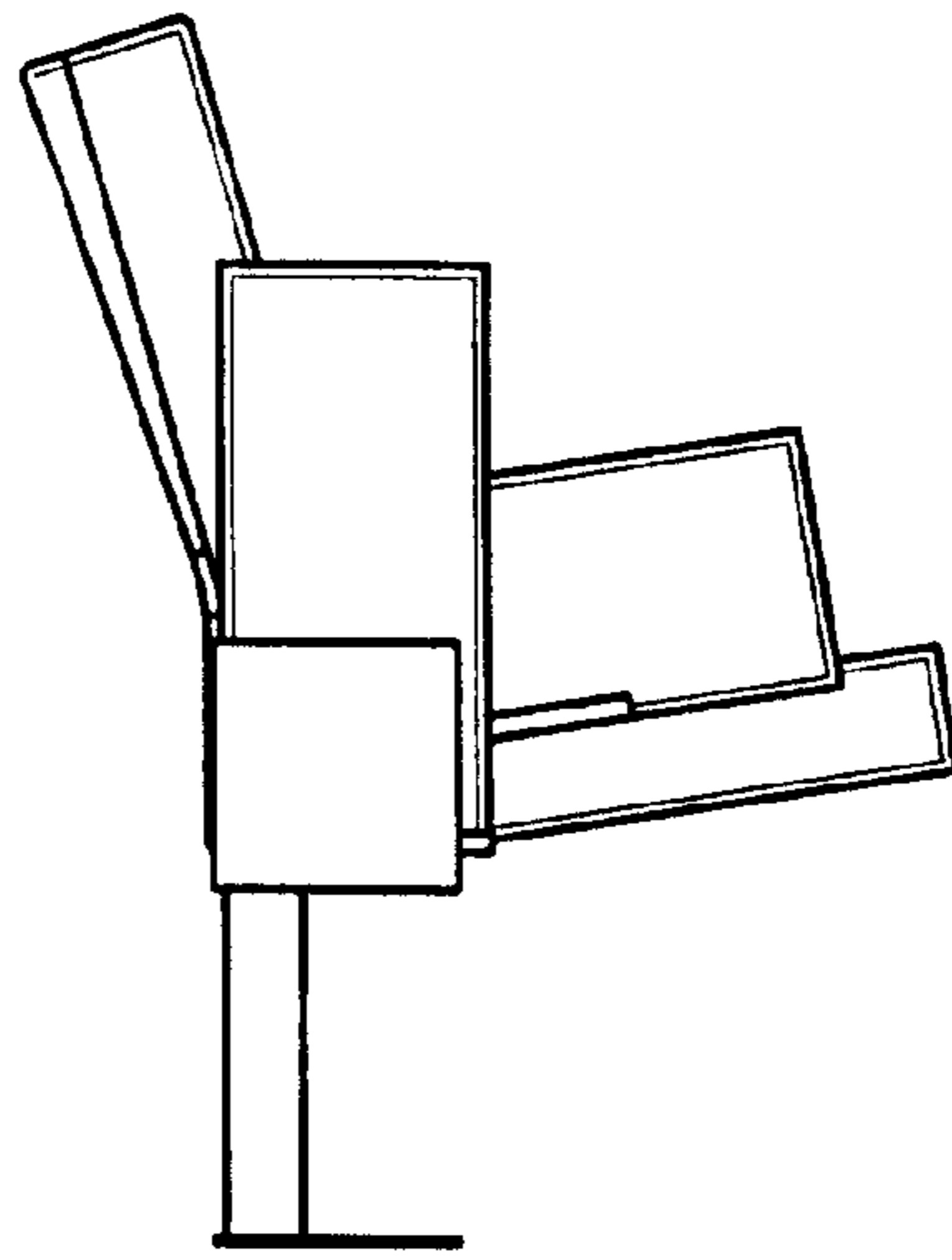

Fig. 11

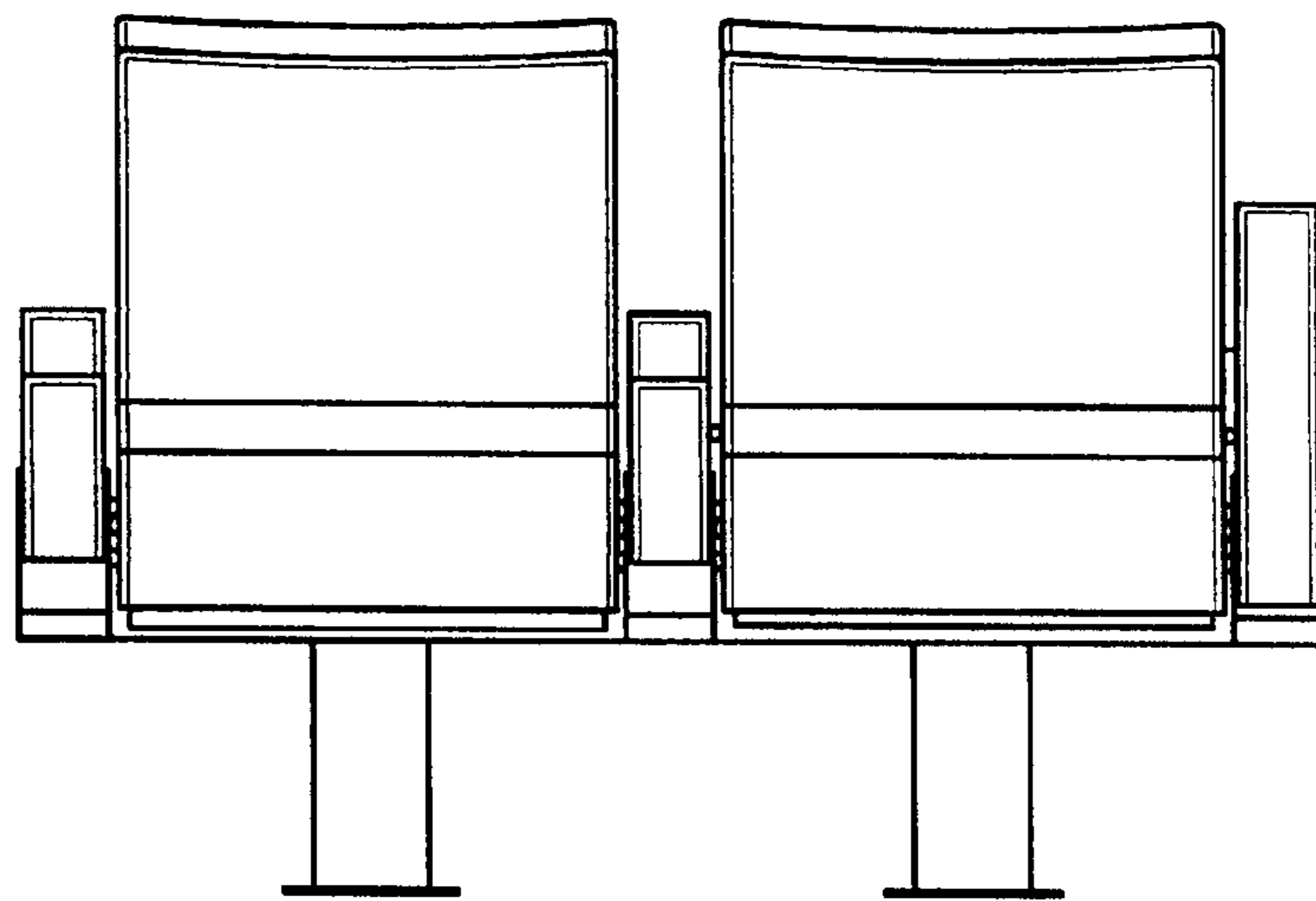

Fig. 12

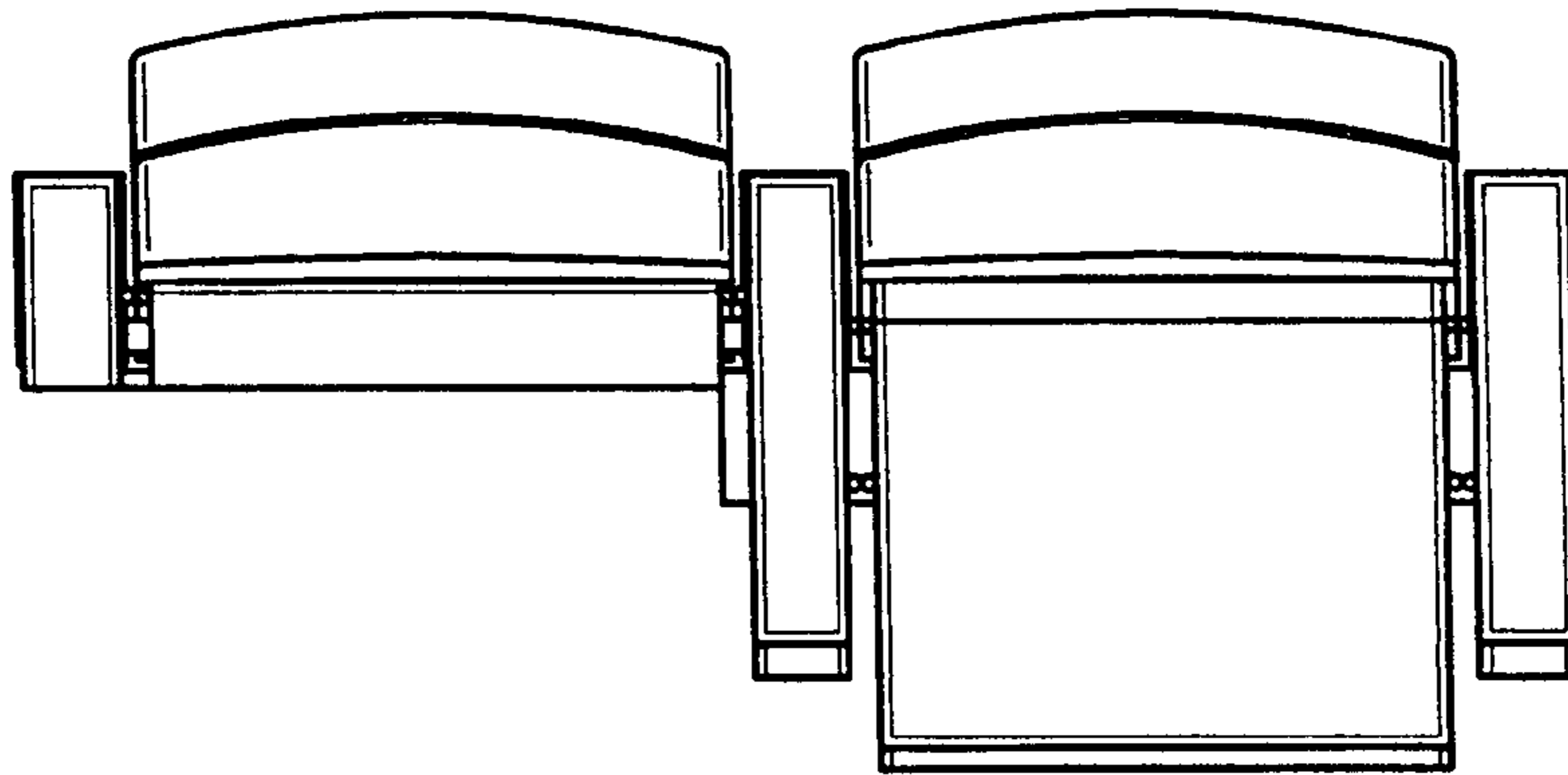

Fig. 13

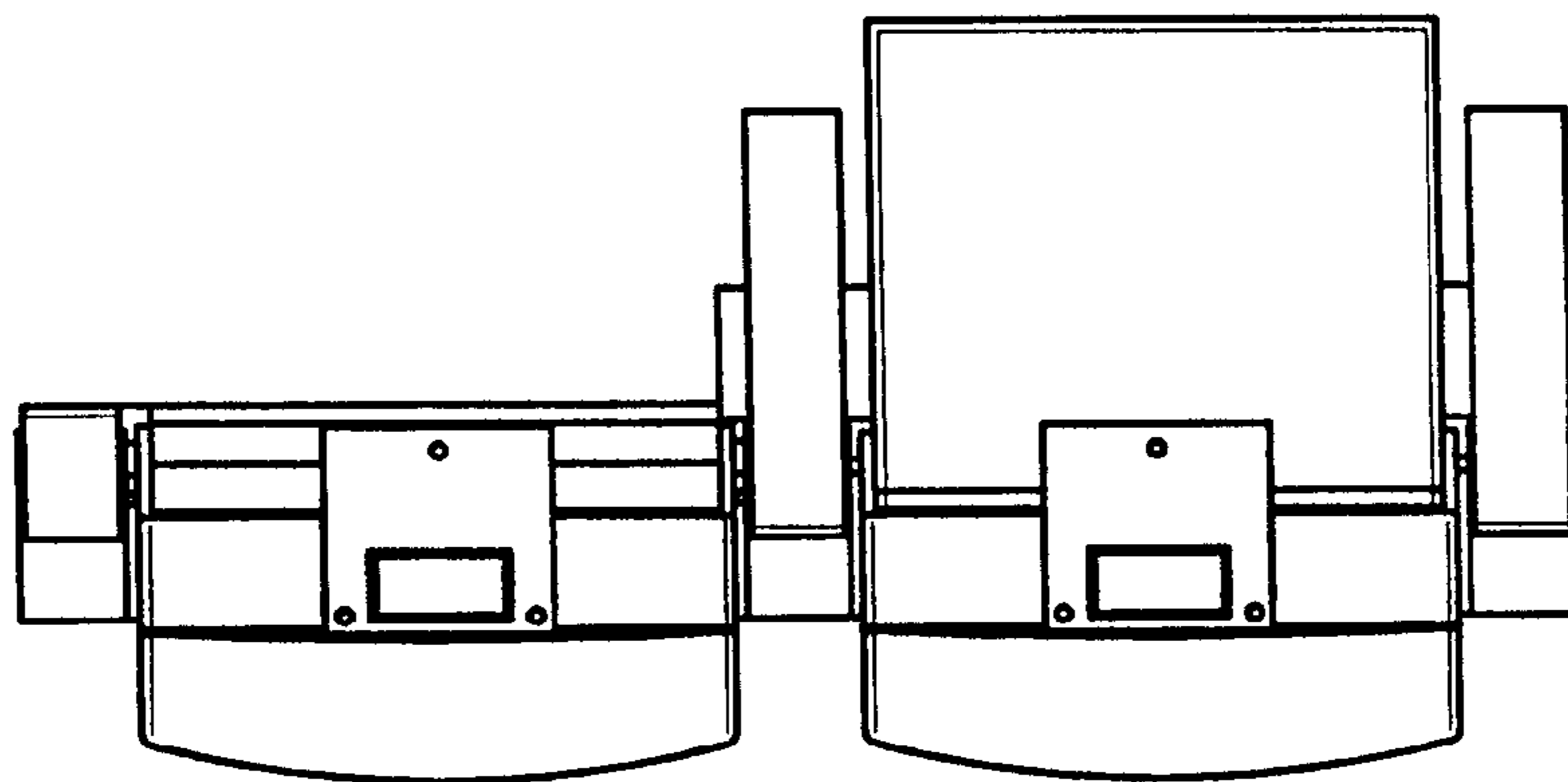

Fig. 14

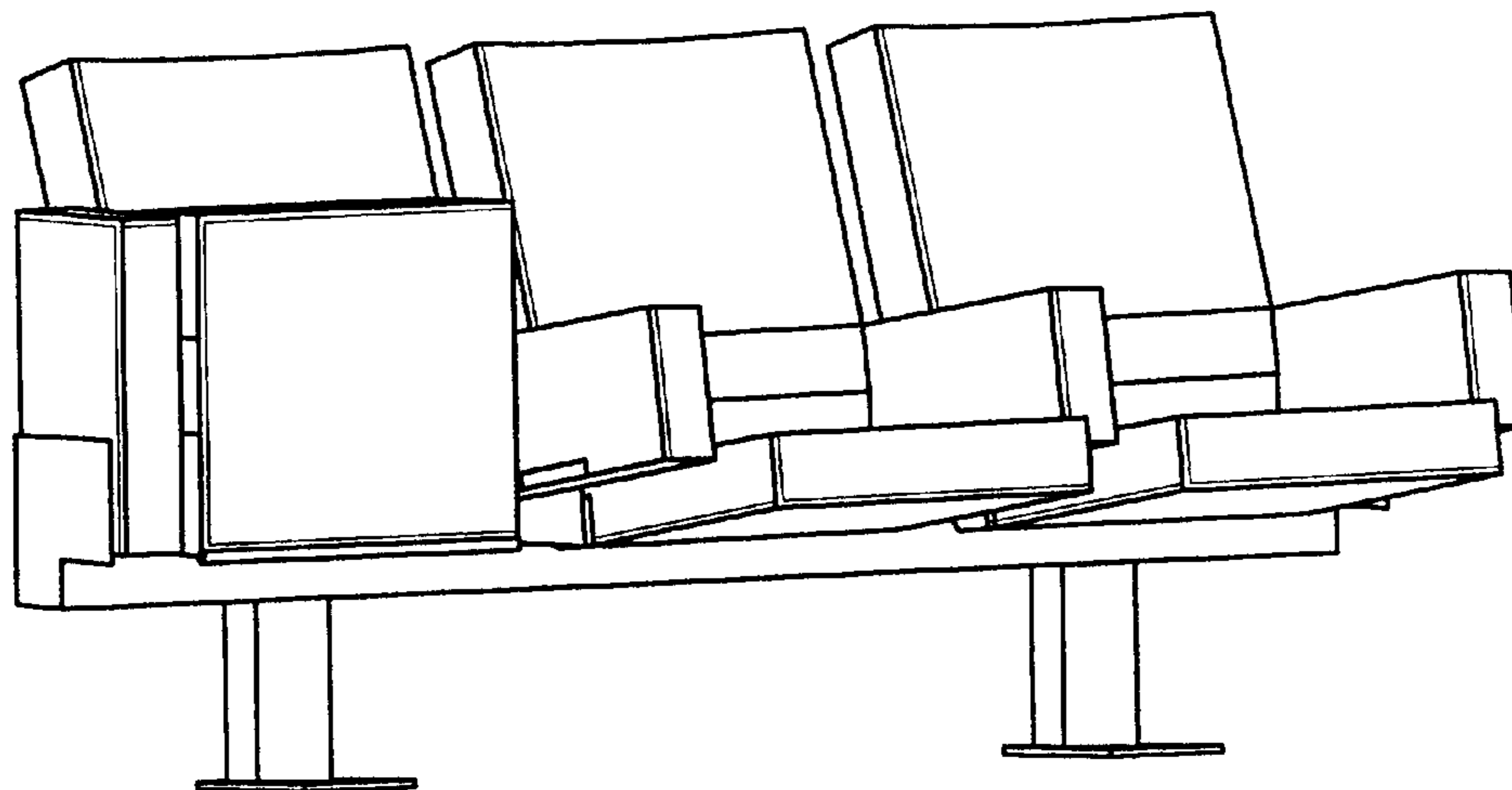

Fig. 15

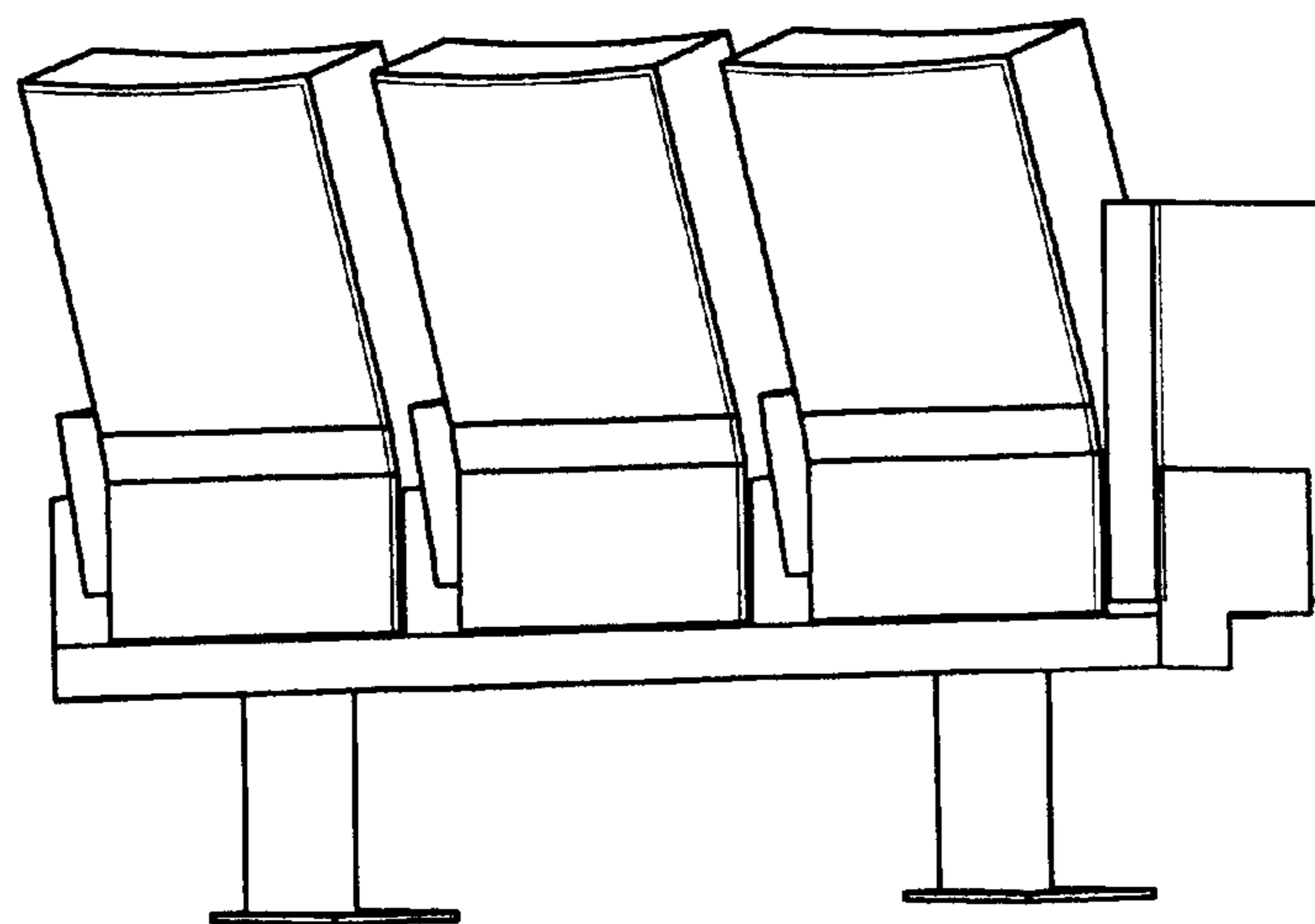

Fig. 16

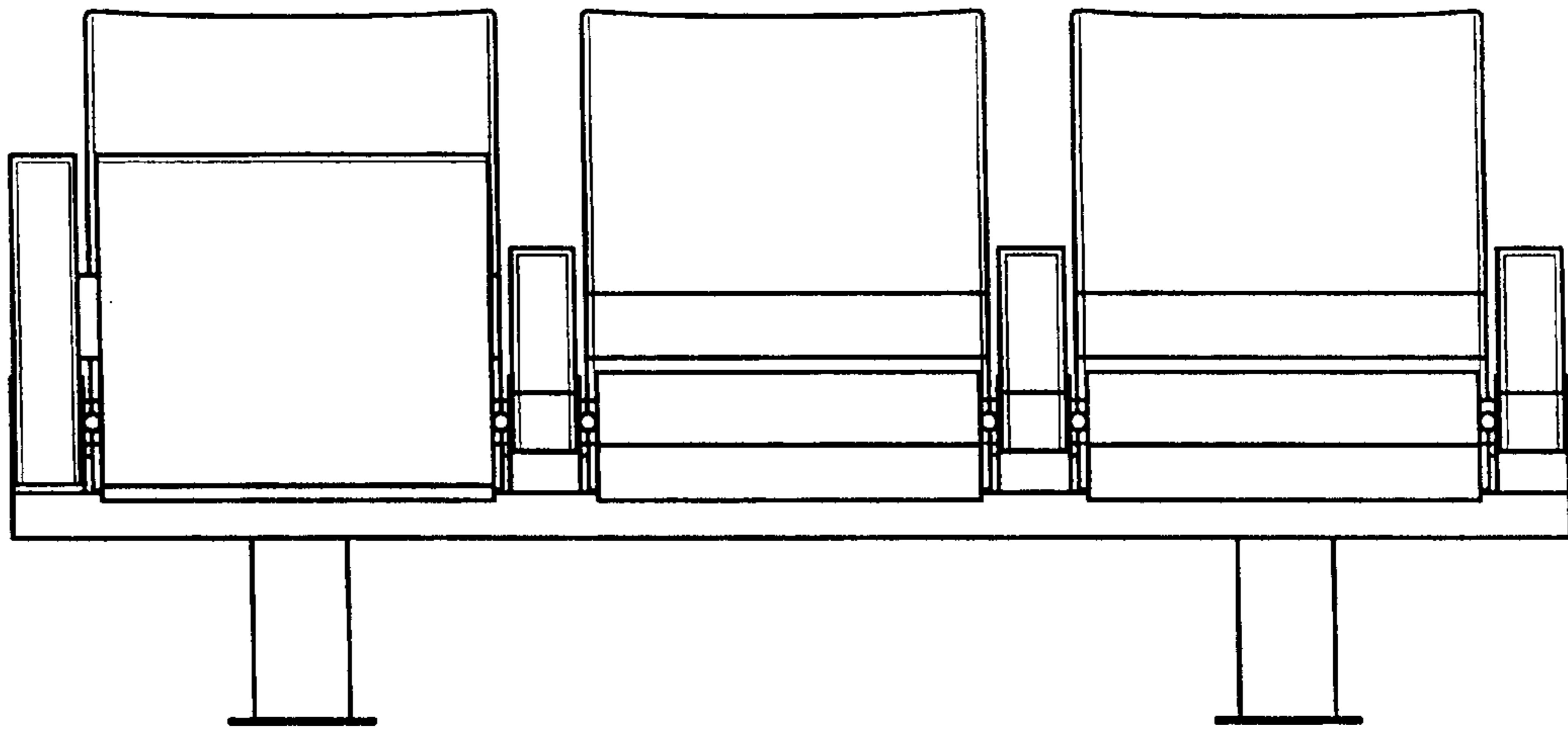

Fig. 17

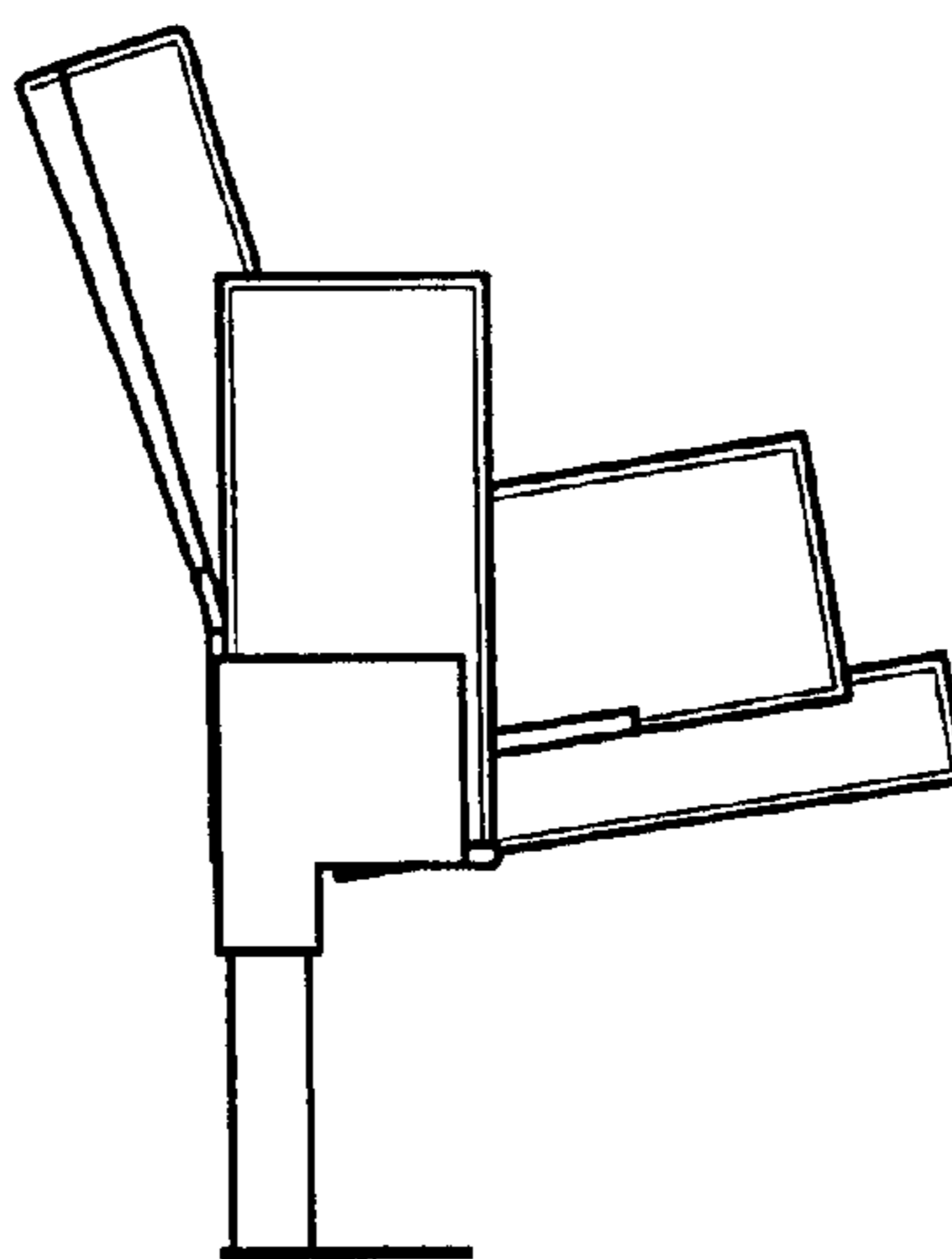

Fig. 18

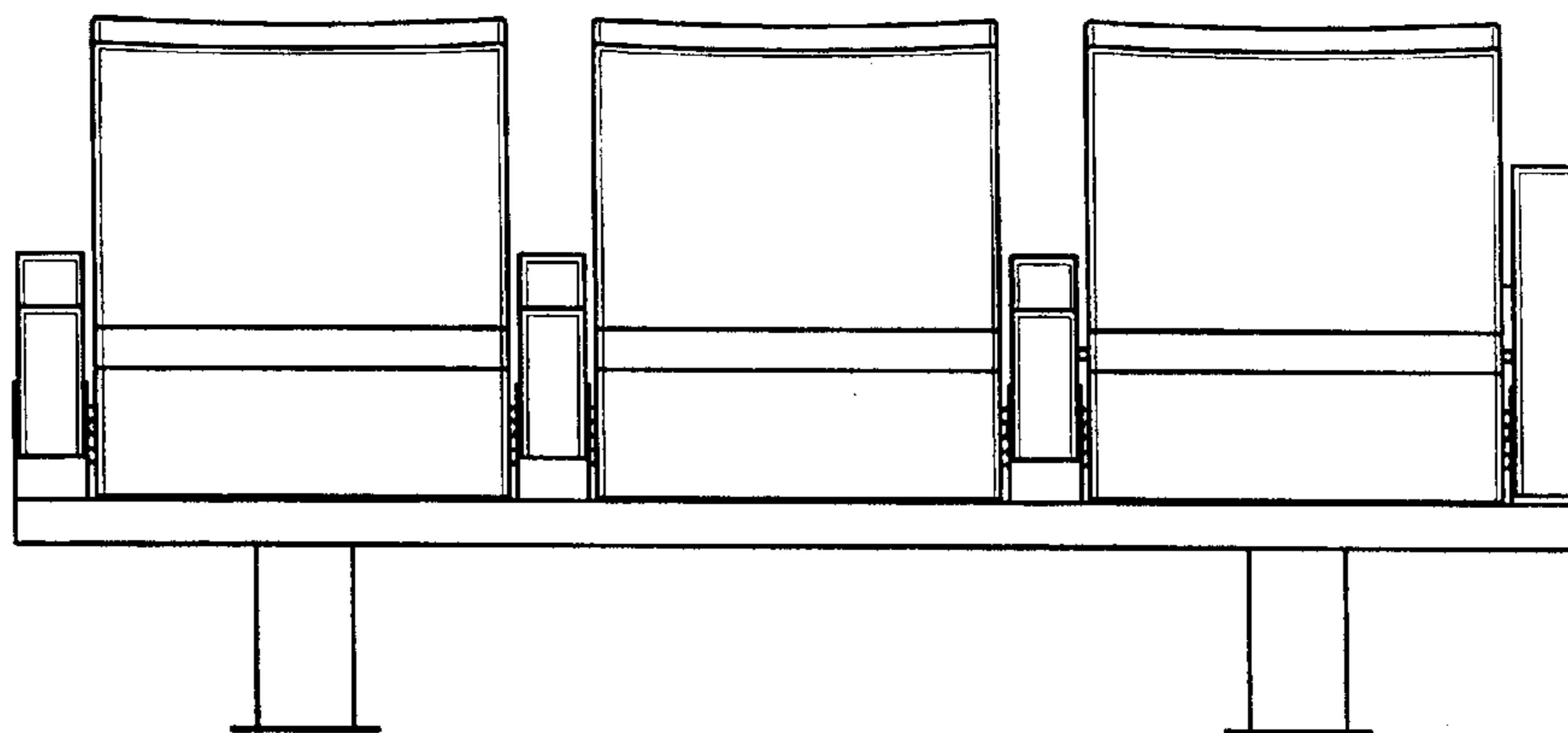

Fig. 19

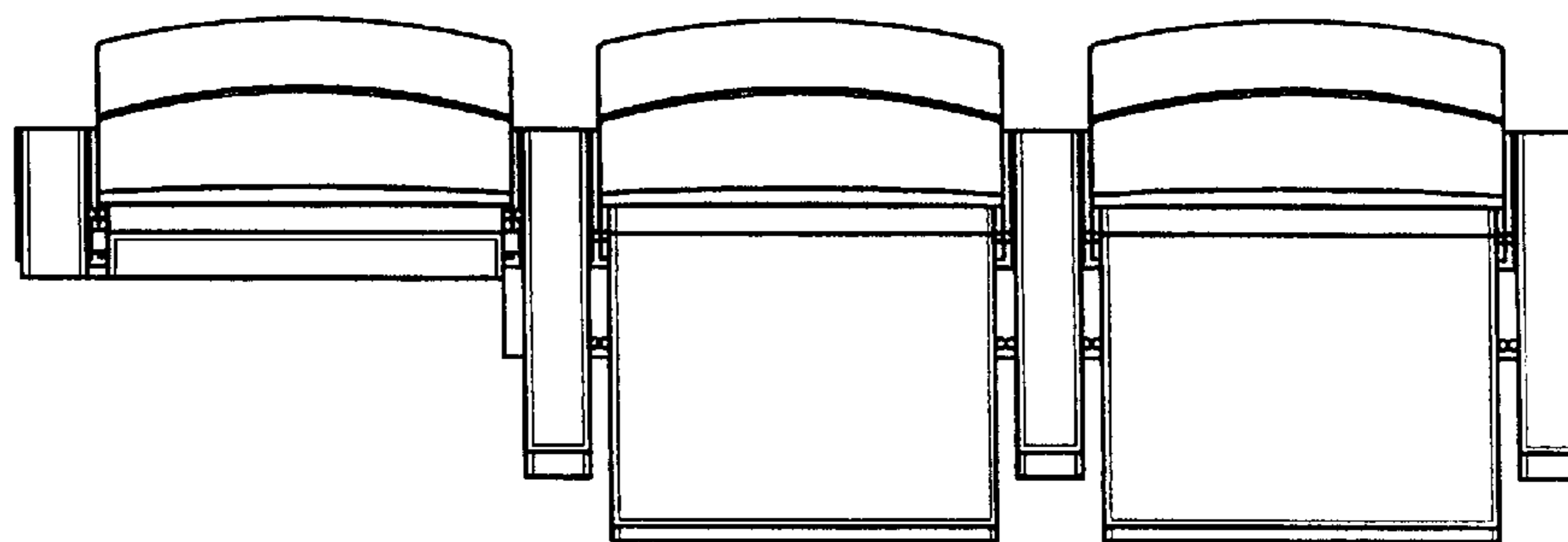

Fig. 20

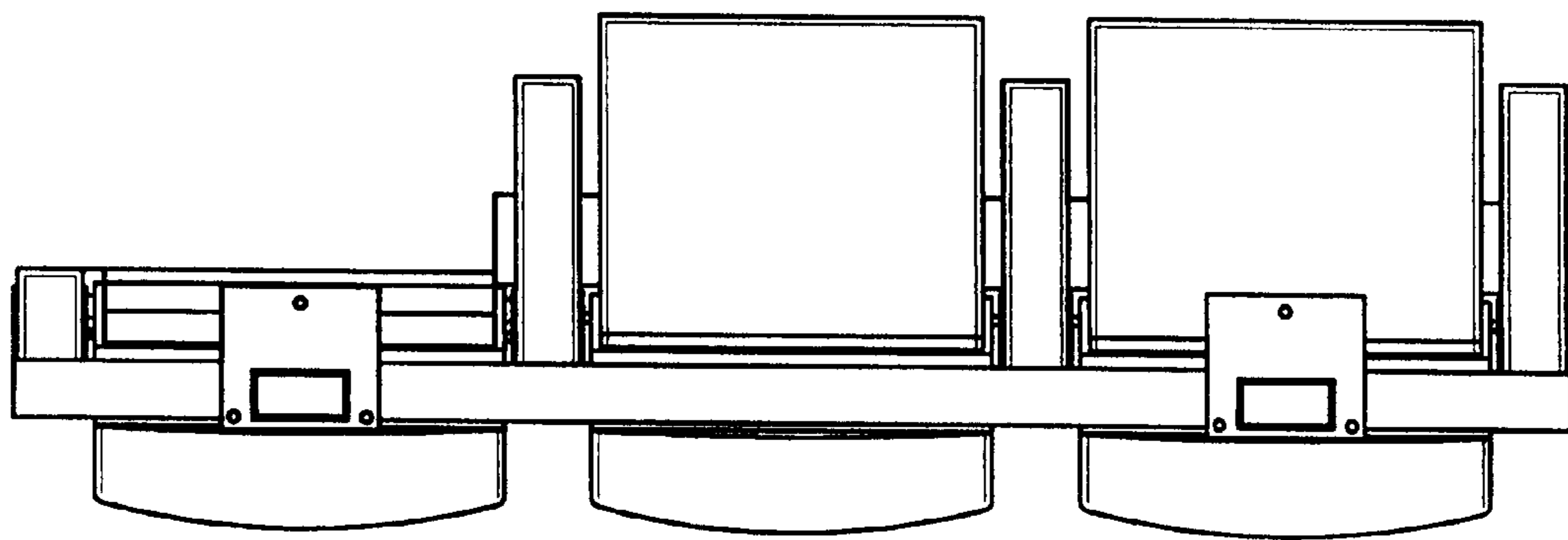

Fig. 21