



US00D532865S

(12) **United States Design Patent** (10) **Patent No.:** **US D532,865 S**  
**Miyazoe et al.** (45) **Date of Patent:** **\*\* \*Nov. 28, 2006**

(54) **ELECTROMAGNETIC VALVE ASSEMBLY**

(75) Inventors: **Shinji Miyazoe**, Ibaraki (JP);  
**Katsuyuki Senba**, Ibaraki (JP)

(73) Assignee: **SMC Corporation**, Tokyo (JP)

(\*) Notice: This patent is subject to a terminal disclaimer.

(\*\*) Term: **14 Years**

(21) Appl. No.: **29/214,694**

(22) Filed: **Oct. 8, 2004**

(30) **Foreign Application Priority Data**

Apr. 9, 2004 (JP) ..... 2004-011002

(51) **LOC (8) Cl.** ..... **23-01**

(52) **U.S. Cl.** ..... **D23/233**

(58) **Field of Classification Search** ..... D23/233-249;  
D15/7, 199; 137/554, 557, 560, 882, 884,  
137/269, 271, 343, 625.64; 251/596.13, 596.16,  
251/331, 219, 15, 130, 129.04; 4/304  
See application file for complete search history.

(56) **References Cited**

**U.S. PATENT DOCUMENTS**

D417,717 S \* 12/1999 Hayashi et al. .... D23/233  
D424,166 S \* 5/2000 Hayashi et al. .... D23/233  
D428,111 S \* 7/2000 Hayashi et al. .... D23/233

6,164,335 A \* 12/2000 Hayashi et al. .... 137/884  
6,520,202 B1 \* 2/2003 Miyazoe et al. .... 137/554  
D479,738 S \* 9/2003 Hayashi et al. .... D23/233  
6,796,329 B1 \* 9/2004 Swenson, Jr. .... 137/625.64  
7,073,825 B1 \* 7/2006 Takada et al. .... 285/124.1

**OTHER PUBLICATIONS**

U.S. Appl. No. 29/214,701, filed Oct. 8, 2004, Miyazoe et al.

\* cited by examiner

*Primary Examiner*—Ian Simmons

*Assistant Examiner*—Maurice Stevens

(74) *Attorney, Agent, or Firm*—Oblon, Spivak, McClelland,  
Maier & Neustadt, P.C.

(57) **CLAIM**

The ornamental design for an electromagnetic valve assembly, as shown and described.

**DESCRIPTION**

FIG. 1 is a top and right front perspective view of an electromagnetic valve assembly, showing our design; FIG. 2 is a top and left rear perspective view thereof; FIG. 3 is a front elevational view thereof; FIG. 4 is a rear elevational view thereof; FIG. 5 is a left side elevational view thereof; FIG. 6 is a right side elevational view thereof; FIG. 7 is a top plan view thereof; and, FIG. 8 is a bottom plan view thereof.

**1 Claim, 3 Drawing Sheets**

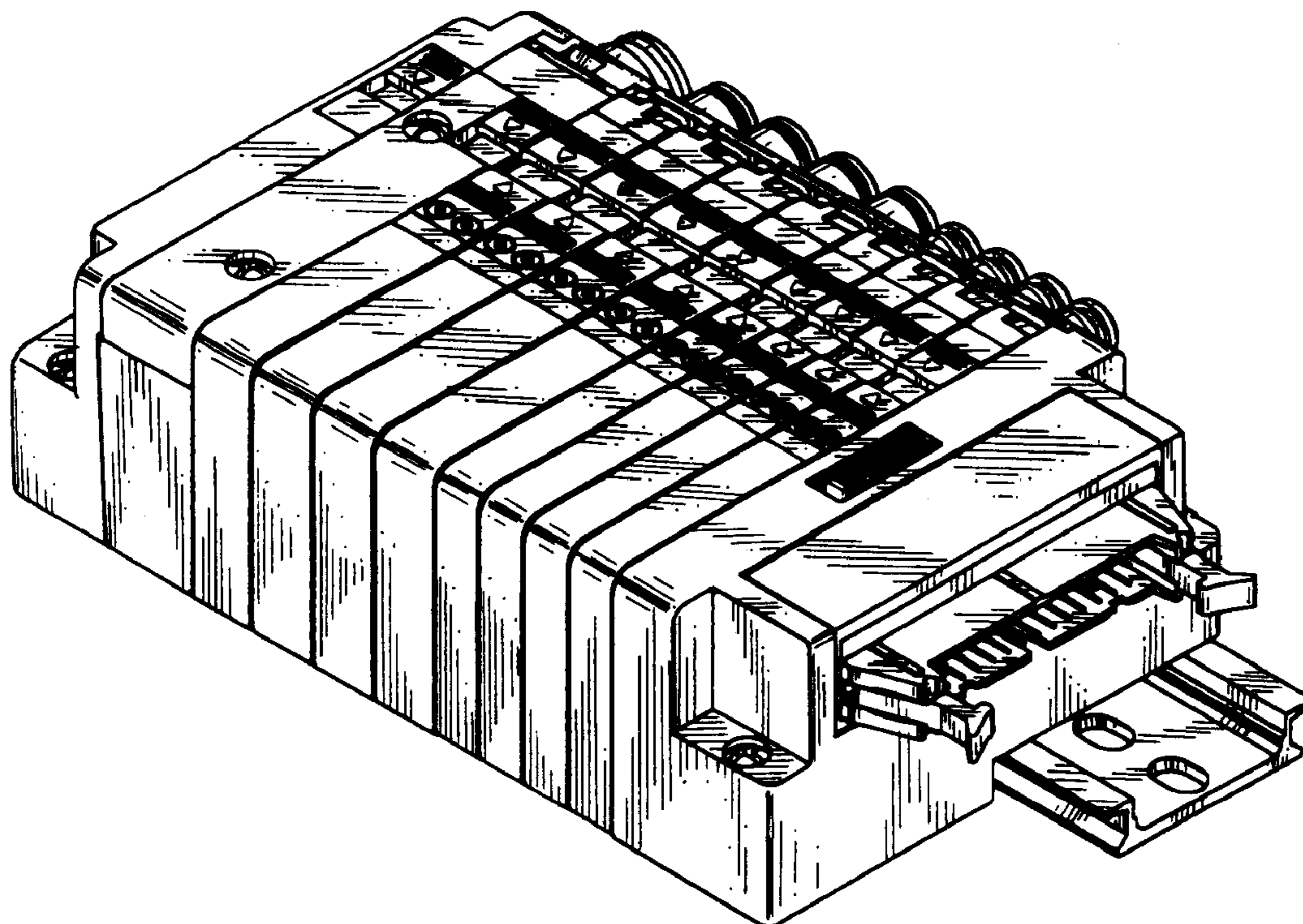

Fig. 1

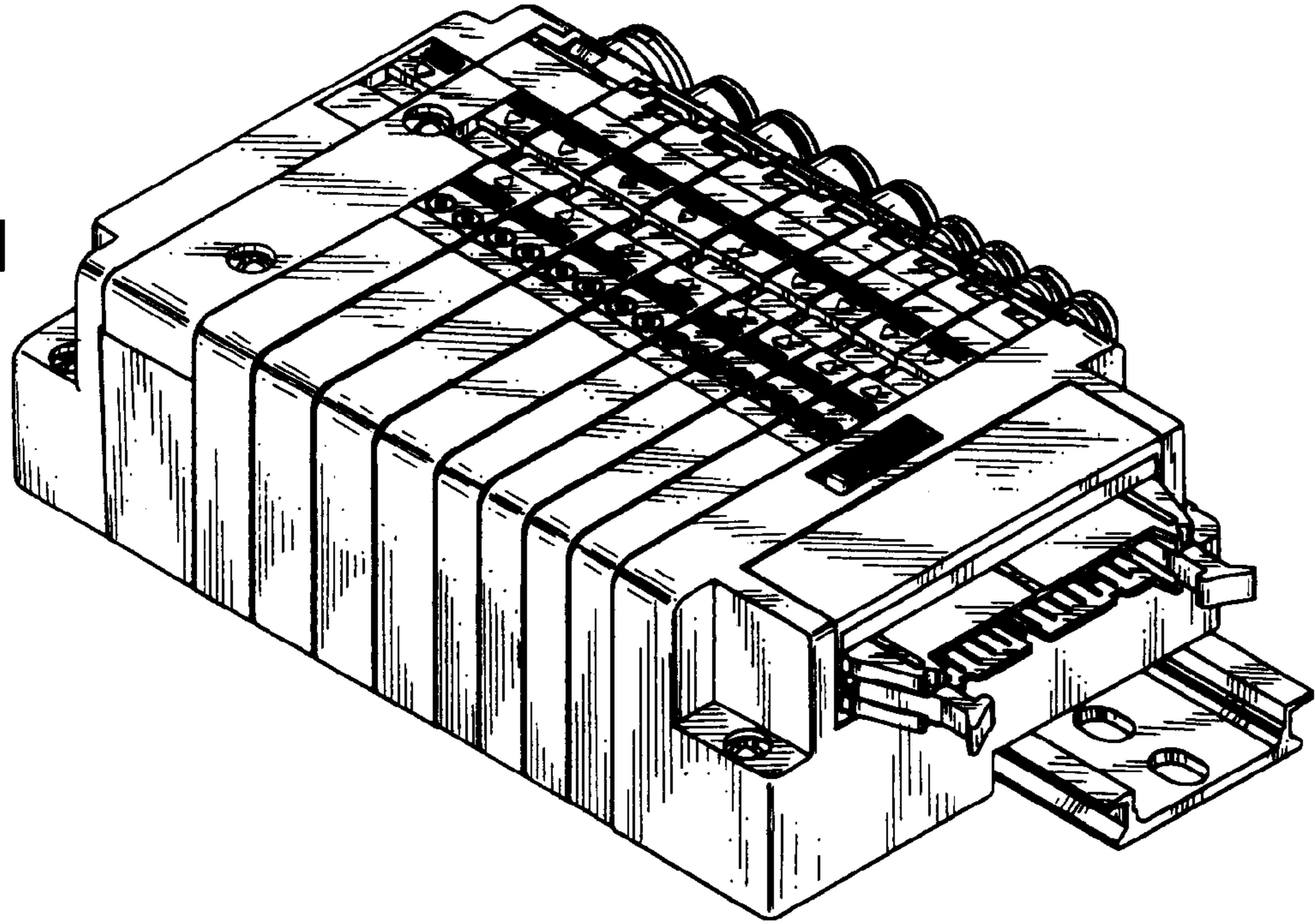

Fig. 2

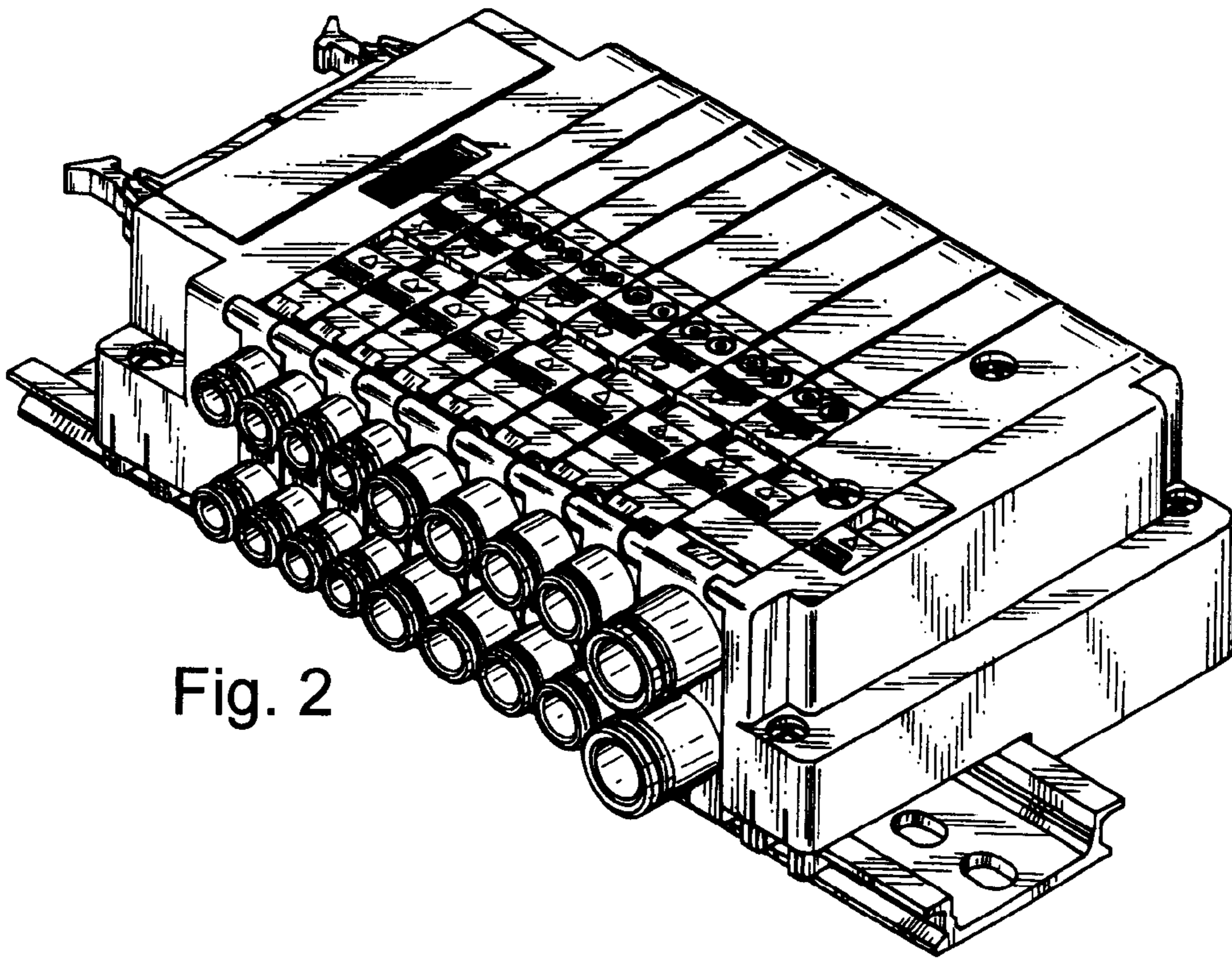



Fig. 3

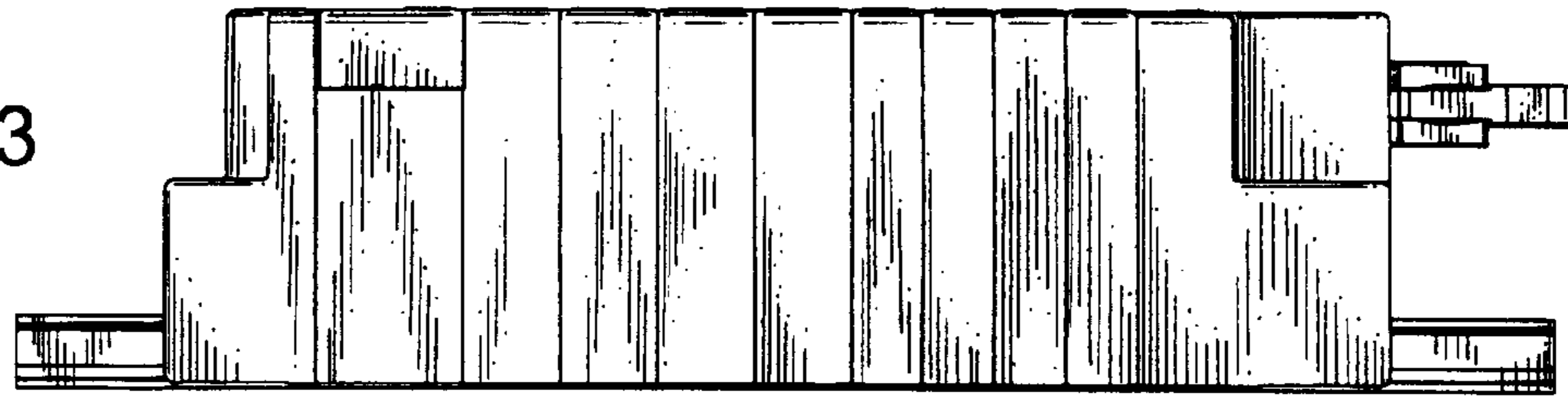

Fig. 4

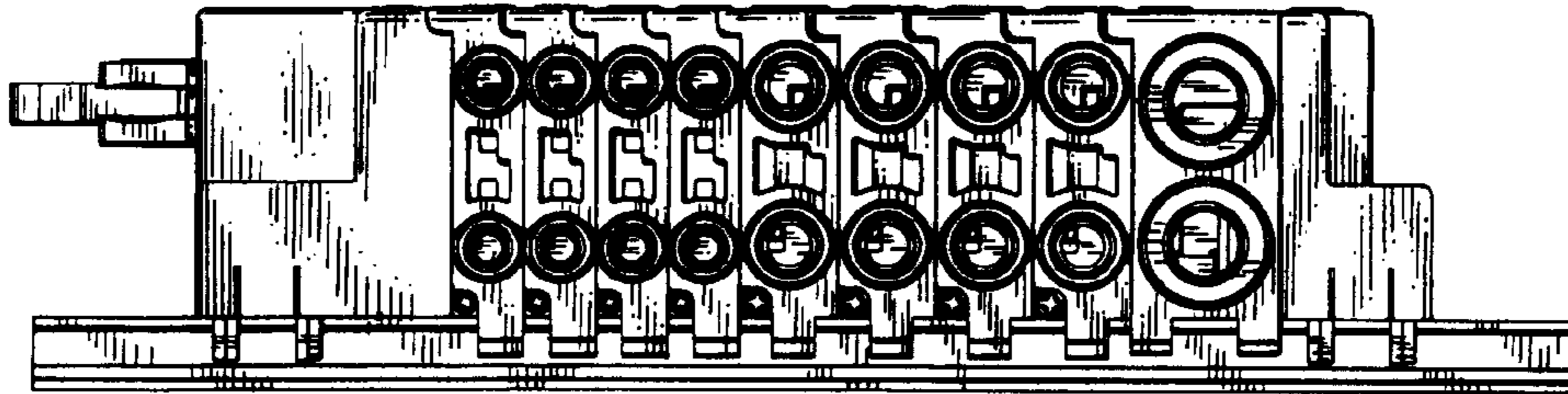

Fig. 5

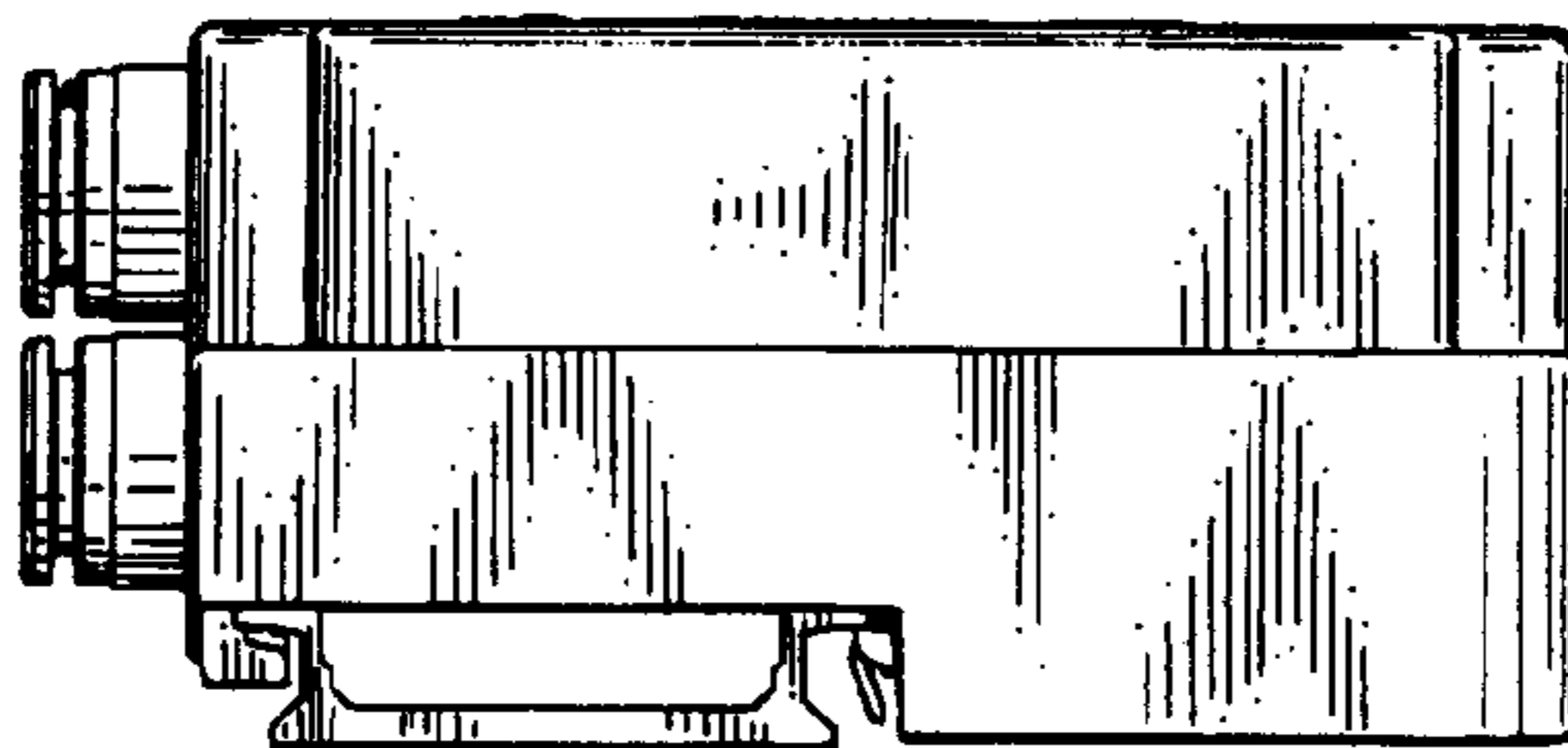
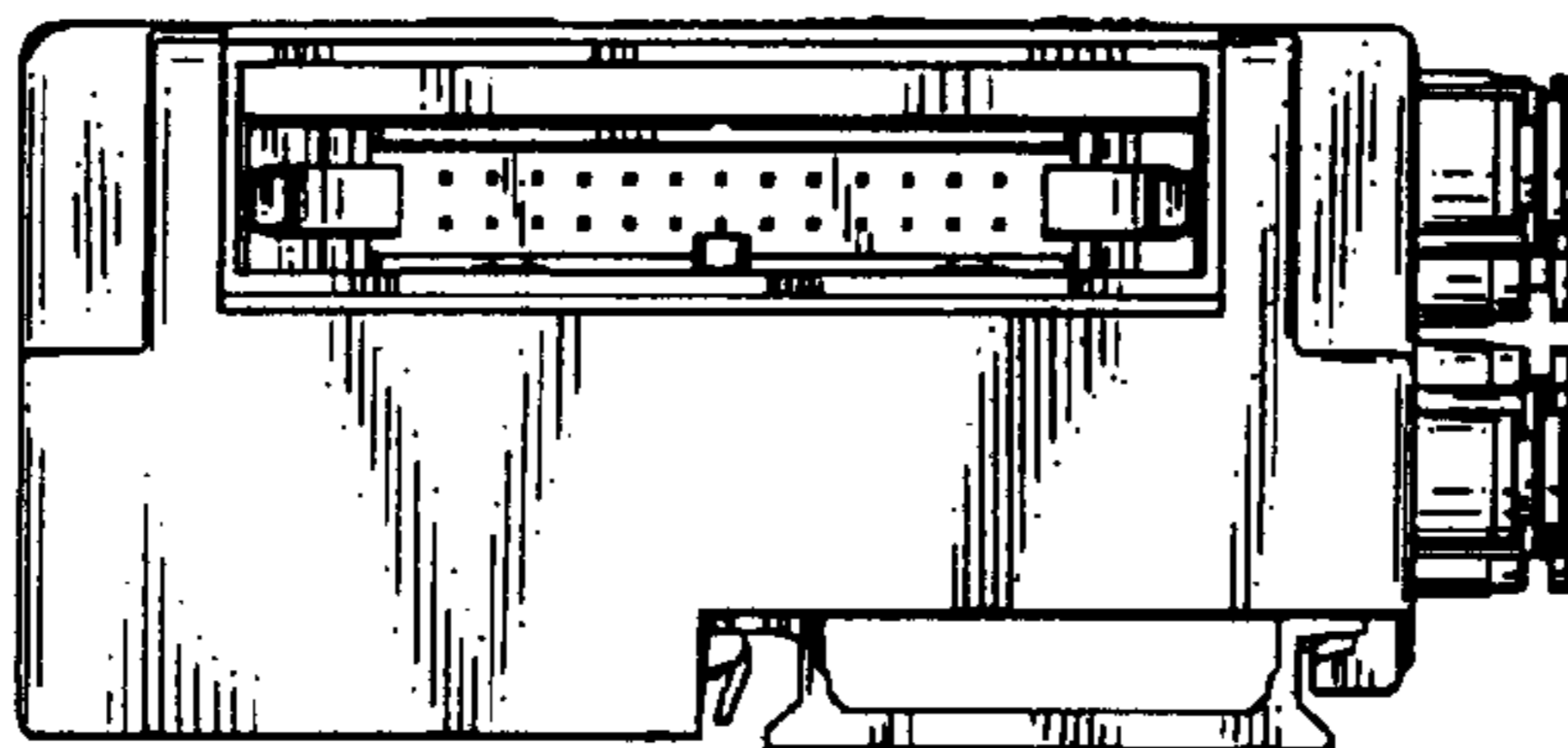

Fig. 6



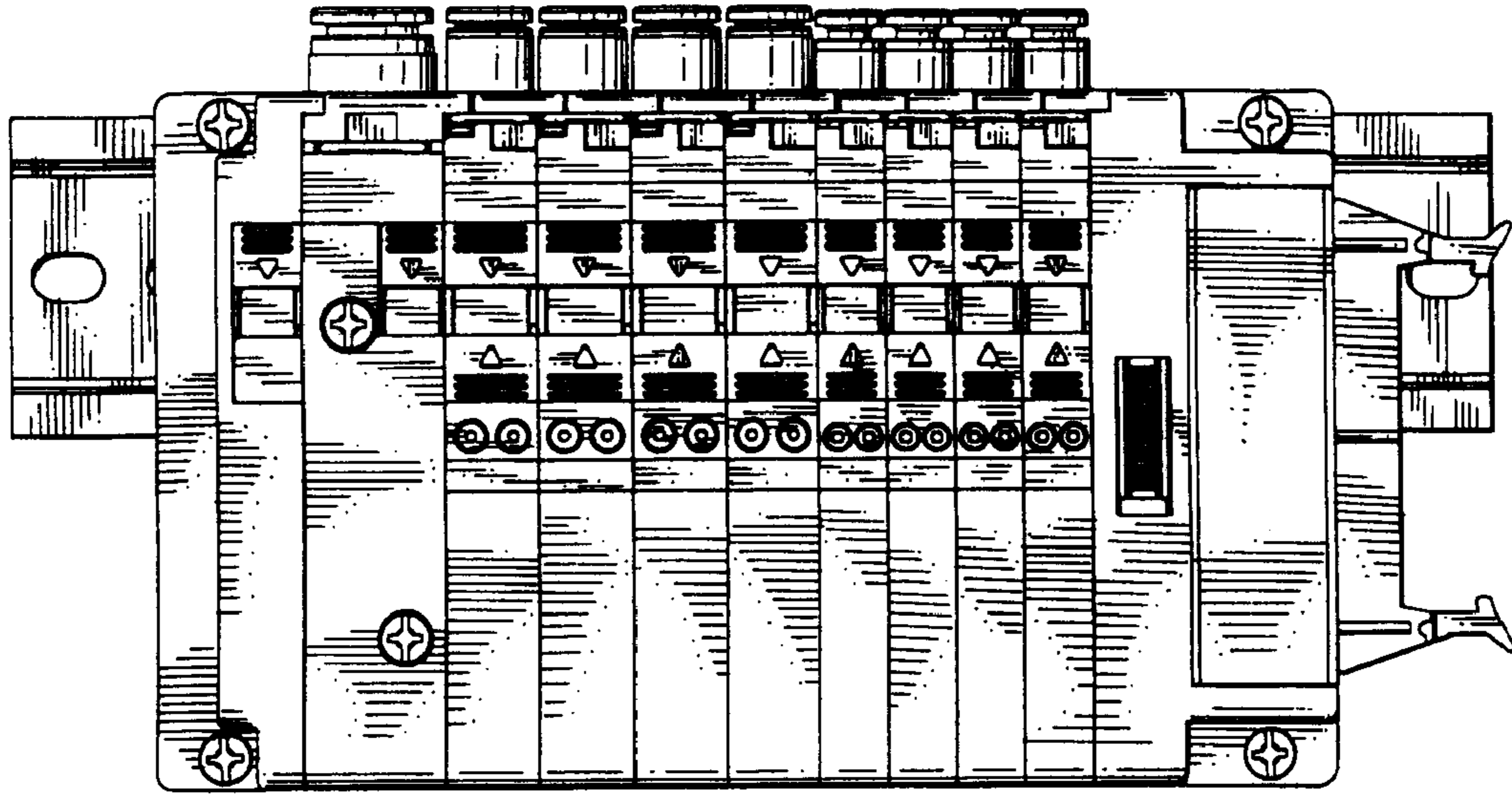

Fig. 7

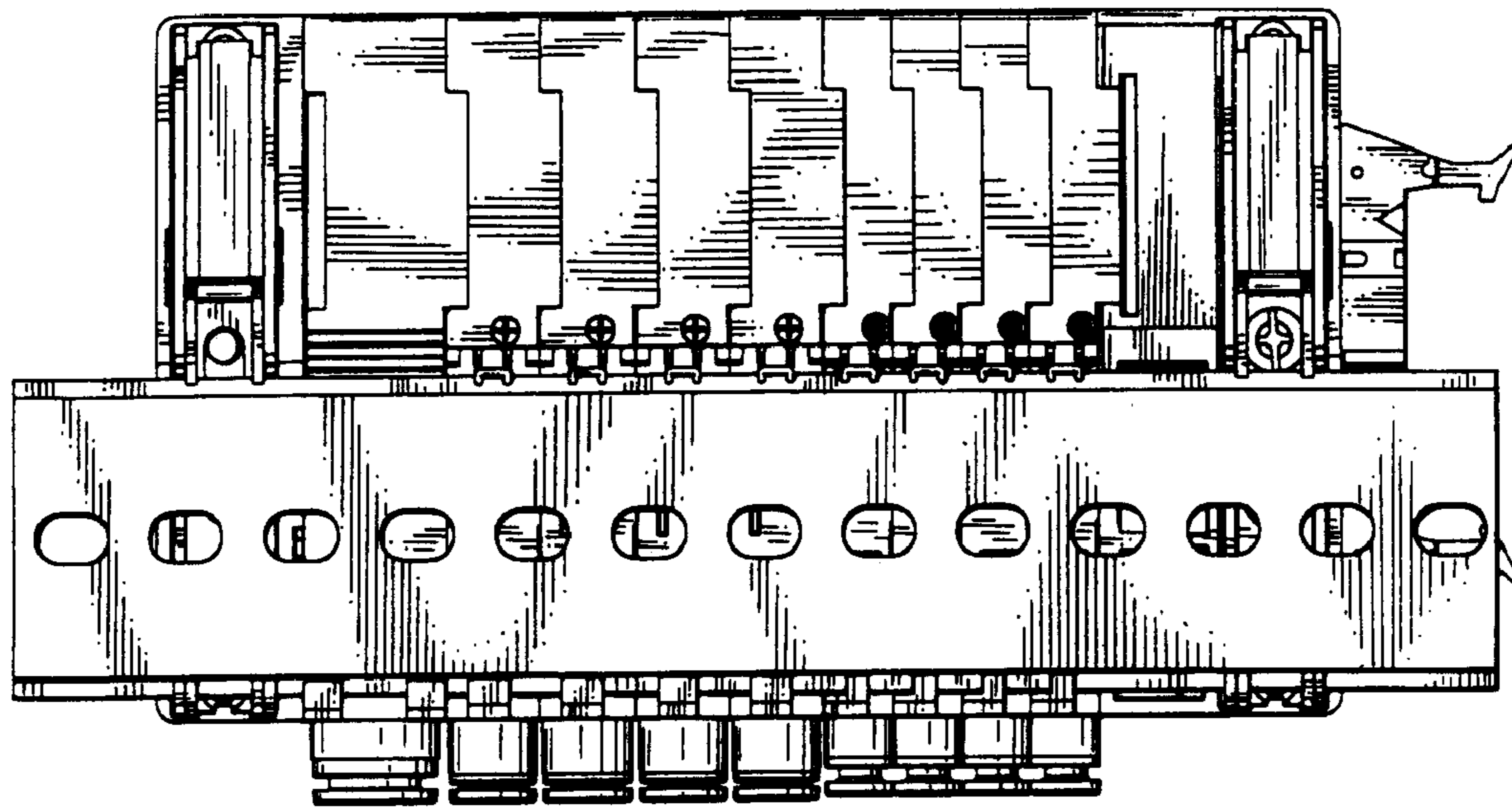

Fig. 8