



US00D532825S

(12) **United States Design Patent**
Bhavnani

(10) **Patent No.:** **US D532,825 S**

(45) **Date of Patent:** **** Nov. 28, 2006**

(54) **DOUBLE CLIPBOARD**

(75) Inventor: **Dilip Bhavnani**, Beverly Hills, CA
(US)

(73) Assignee: **Suncoast Merchandise Corporation**,
Commerce, CA (US)

(**) Term: **14 Years**

(21) Appl. No.: **29/245,147**

(22) Filed: **Dec. 19, 2005**

(51) **LOC (8) Cl.** **19-02**

(52) **U.S. Cl.** **D19/88**

(58) **Field of Classification Search** D6/406.3,
D6/420; D19/52, 78, 86, 87, 88, 90, 91, 92;
24/67.3, 67.5, 67.7; 211/50; 248/447, 452;
281/44, 45; 362/99

See application file for complete search history.

(56) **References Cited**

U.S. PATENT DOCUMENTS

- D406,169 S * 2/1999 Wolff D19/65
- D446,549 S * 8/2001 Cheris et al. D19/88
- D455,024 S * 4/2002 Mimick et al. D6/406.3
- D472,728 S * 4/2003 Harris et al. D6/406.3

- 6,691,442 B1 * 2/2004 Gross 40/495
- D490,472 S * 5/2004 Nuttall et al. D19/88
- D495,369 S * 8/2004 Holland D19/88
- D501,883 S * 2/2005 Berglas D19/52
- D518,525 S 4/2006 Bhavnani
- D519,158 S * 4/2006 Wolff et al. D19/88
- D521,561 S * 5/2006 Wolff et al. D19/88

* cited by examiner

Primary Examiner—Elizabeth A. Albert

(74) *Attorney, Agent, or Firm*—The Soni Law Group

(57) **CLAIM**

The ornamental design for a double clipboard, as shown and described.

DESCRIPTION

The present invention relates to a clipboard having two surfaces for clipping objects thereto.

FIG. 1 is a front side perspective view of the double clipboard showing my new design;

FIG. 2 is a front view thereof;

FIG. 3 is a side view thereof;

FIG. 4 is a bottom view thereof;

FIG. 5 is a top view thereof; and,

FIG. 6 is a back side perspective view thereof.

1 Claim, 4 Drawing Sheets

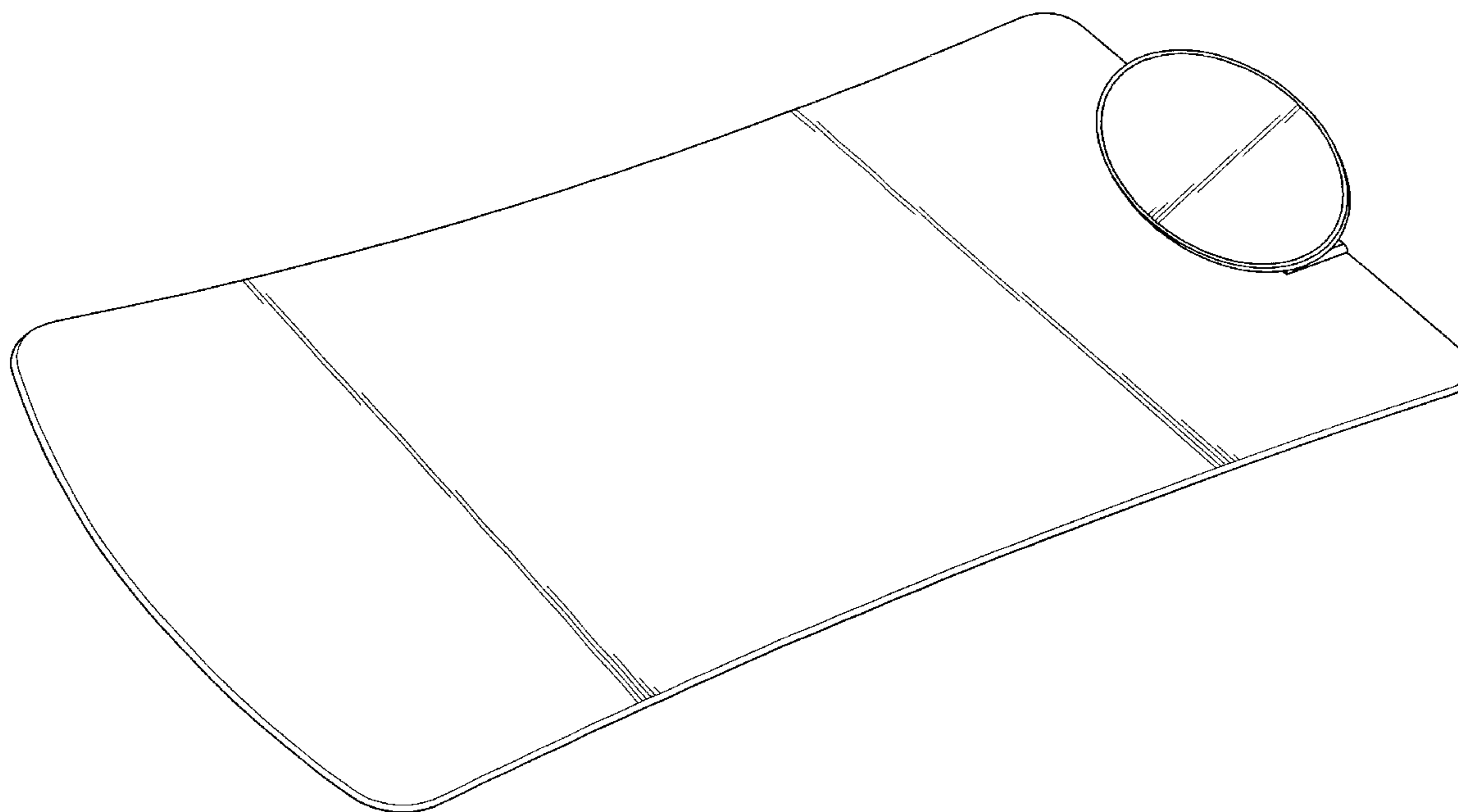

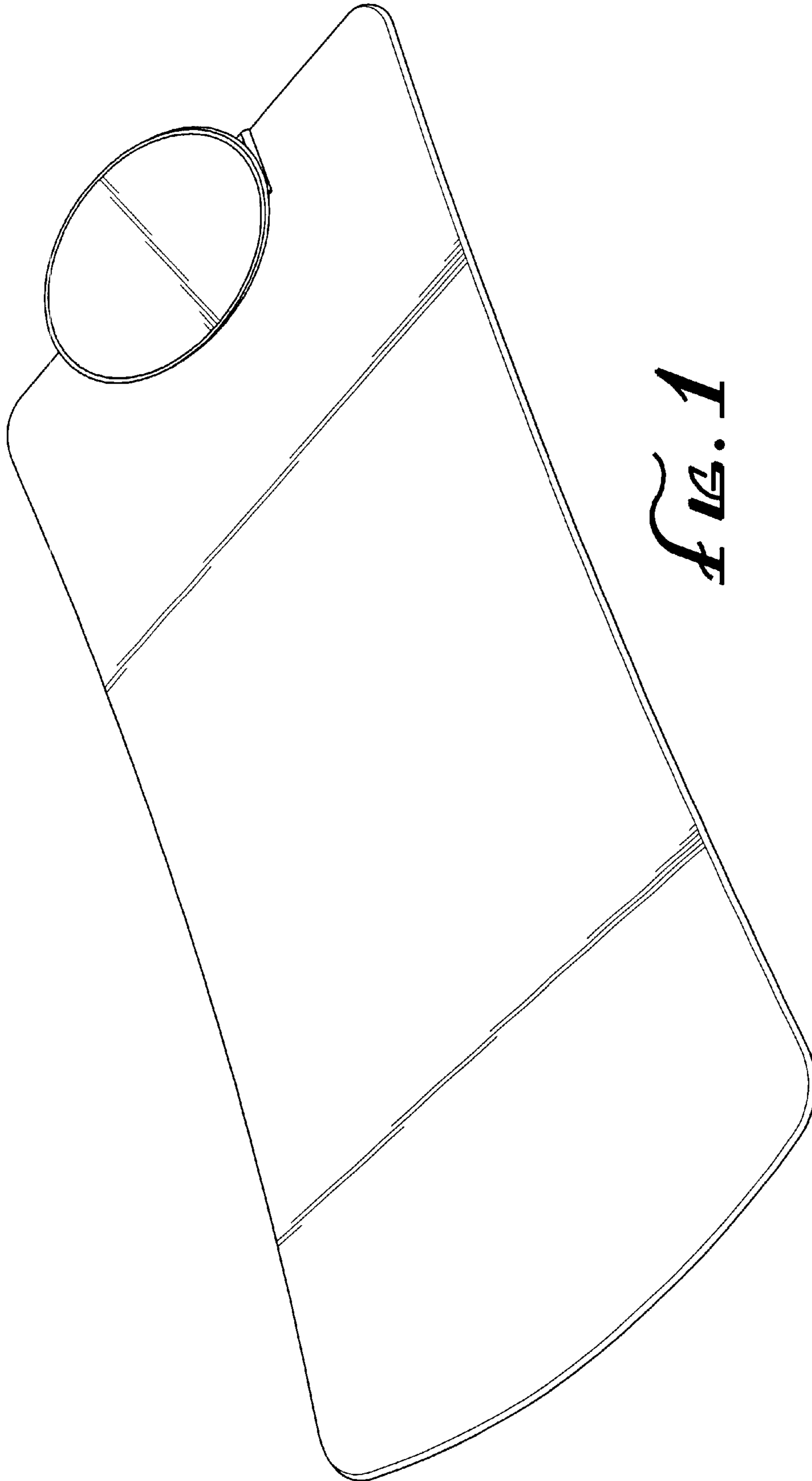

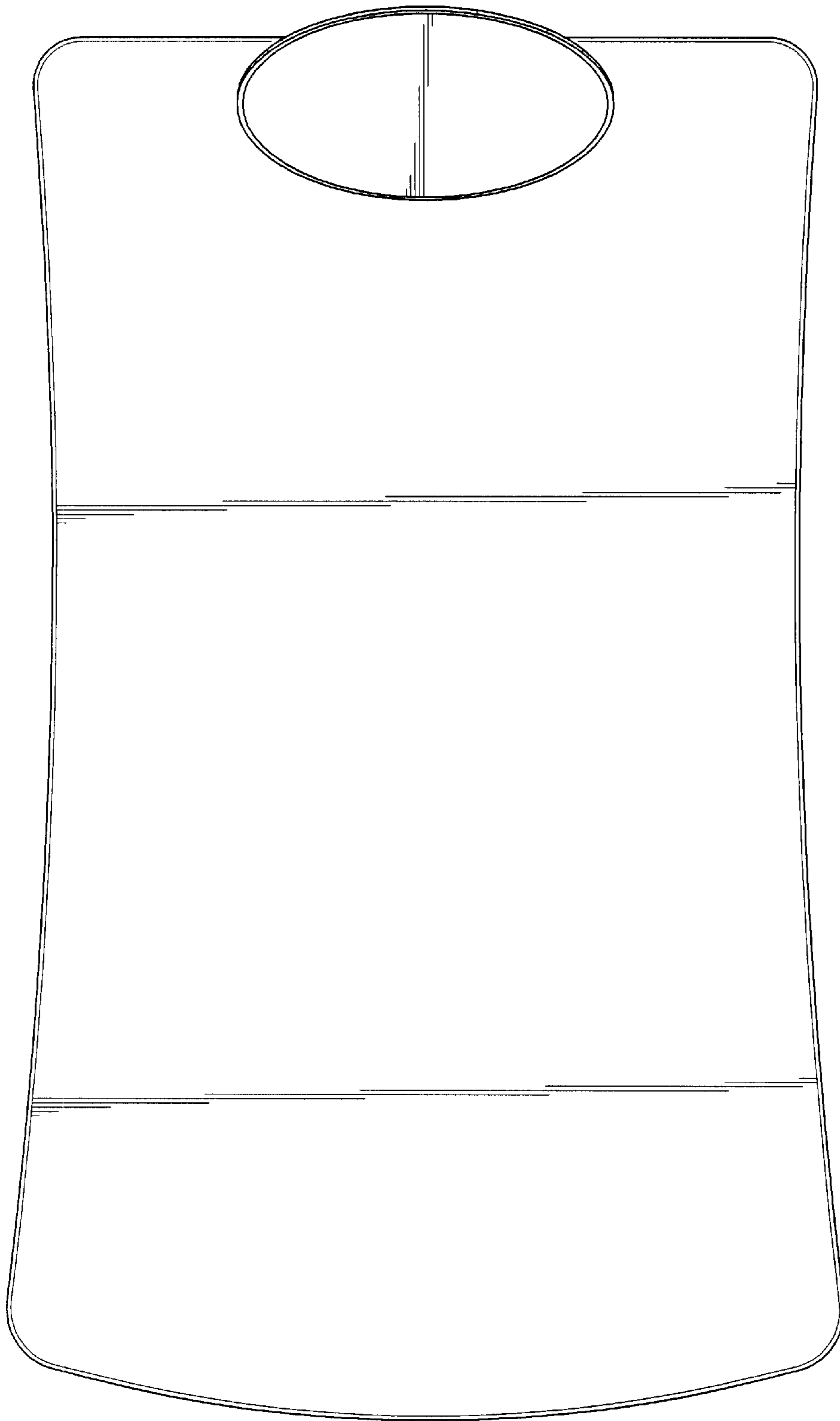
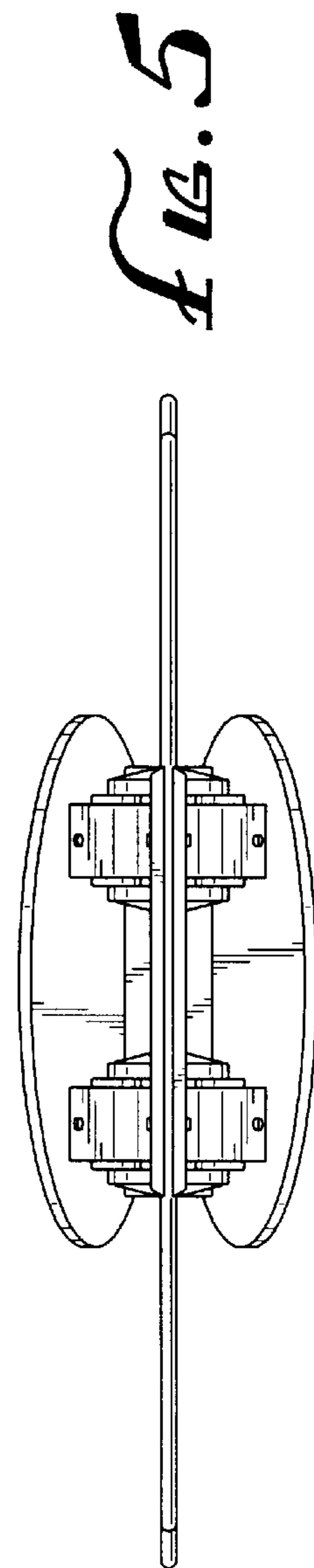
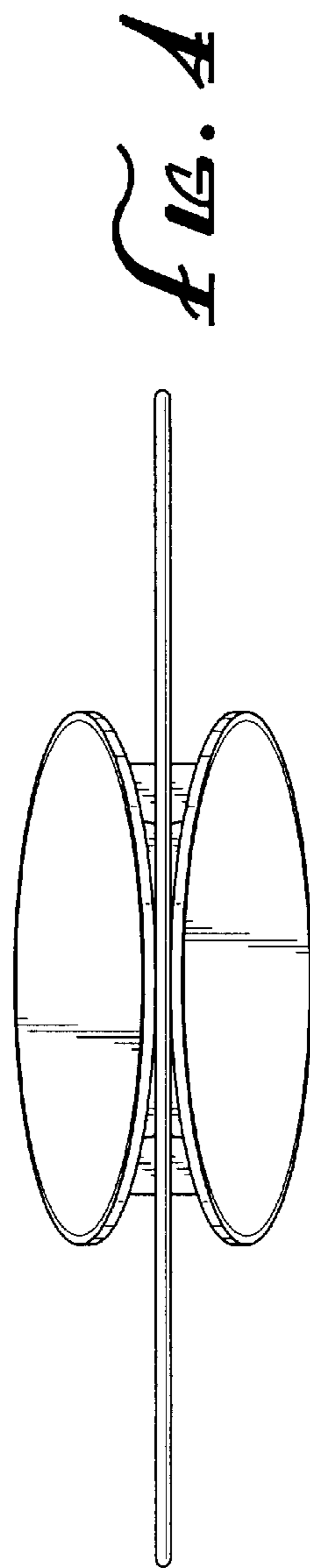
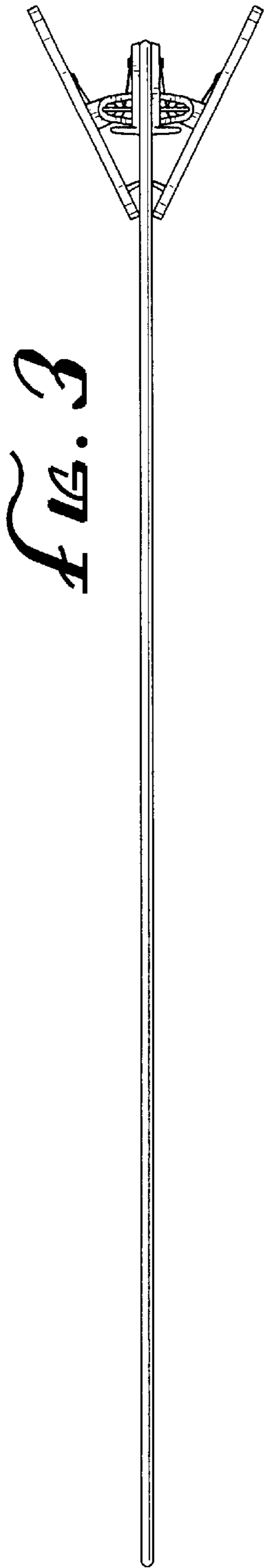

FIG. 2



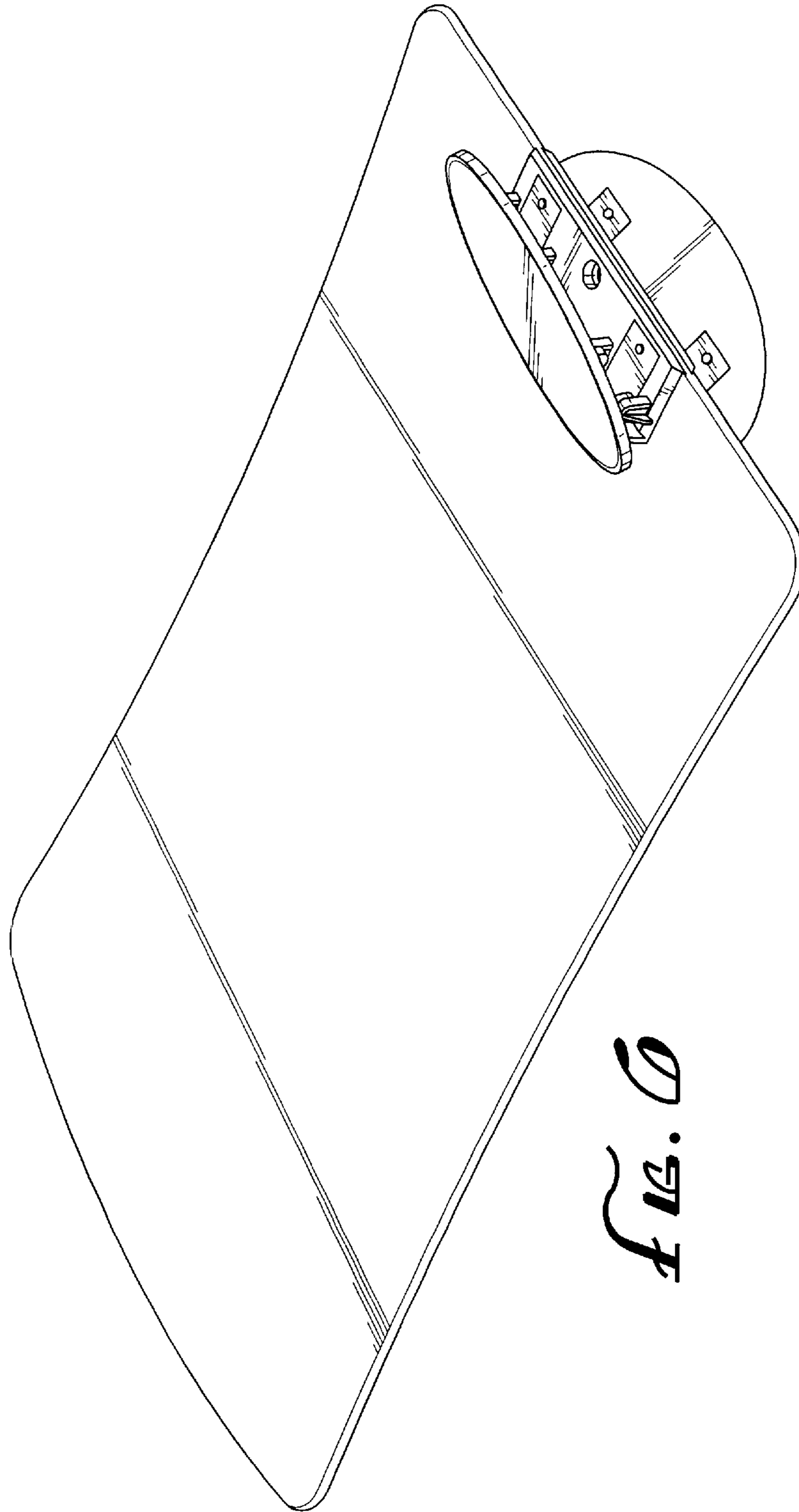

FIG. 10

UNITED STATES PATENT AND TRADEMARK OFFICE
CERTIFICATE OF CORRECTION

PATENT NO. : Des. 532,825 S
APPLICATION NO. : 29/245147
DATED : November 28, 2006
INVENTOR(S) : Dilip Bhavnani

Page 1 of 1

It is certified that error appears in the above-identified patent and that said Letters Patent is hereby corrected as shown below:

On Title Page, Item (74) should be The Soni Law Firm.

Signed and Sealed this

Thirteenth Day of March, 2007

A handwritten signature in black ink on a light gray dotted background. The signature reads "Jon W. Dudas" in a cursive style.

JON W. DUDAS

Director of the United States Patent and Trademark Office