



US00D532820S

(12) **United States Design Patent**
Smith

(10) **Patent No.:** **US D532,820 S**

(45) **Date of Patent:** **** Nov. 28, 2006**

(54) **PAIRED BOOKENDS**

(76) **Inventor:** **Stephen F. Smith**, 2311 Bottle Bay Rd., Sagle, ID (US) 83860

(**) **Term:** **14 Years**

(21) **Appl. No.:** **29/255,907**

(22) **Filed:** **Mar. 14, 2006**

(51) **LOC (8) Cl.** **19-99**

(52) **U.S. Cl.** **D19/34.3**

(58) **Field of Classification Search** D19/34.1-34.5;
211/42-43, 50; 248/441.1; D7/688; 15/245
See application file for complete search history.

(56) **References Cited**

U.S. PATENT DOCUMENTS

D61,430 S	*	8/1922	Wunsch	D19/34.3
2,065,886 A	*	12/1936	Clift	15/245
D198,918 S	*	8/1964	Biallas	D19/34.3
3,150,879 A		9/1964	Head		
3,165,204 A	*	1/1965	Spencer	211/42
3,561,782 A		2/1971	Tyrack		
D243,265 S		2/1977	Koblick		
D257,806 S		1/1981	Maune		
4,316,620 A		2/1982	Wien		
D263,410 S		3/1982	Wien		
4,596,405 A		6/1986	Jones		
4,645,235 A		2/1987	Joseph		
4,874,099 A	*	10/1989	Arnott et al.	211/50
5,294,152 A		3/1994	Jacobs		

D356,352 S		3/1995	Johnson		
D362,017 S		9/1995	McConnell		
5,491,869 A	*	2/1996	Sullivan et al.	15/245
5,505,492 A		4/1996	Nelson		
5,538,285 A		7/1996	Goode		
D388,823 S	*	1/1998	Bright	D19/34.1
6,152,491 A		11/2000	Queentry		
D522,056 S	*	5/2006	Smith	D19/34.3
2001/0011817 A1		8/2001	Zaltron		
2004/0178621 A1		9/2004	Martin		

* cited by examiner

Primary Examiner—Robert A. Delehanty

Assistant Examiner—Mark Cavanna

(74) *Attorney, Agent, or Firm*—Wells St. John P.S.

(57) **CLAIM**

The ornamental design for paired bookends, as shown and described.

DESCRIPTION

FIG. 1 is a perspective view of the paired bookends showing my new design.

FIG. 2 is a right side view thereof;

FIG. 3 is a top view thereof;

FIG. 4 is a bottom view thereof;

FIG. 5 is a front view thereof; and,

FIG. 6 is a back view thereof.

The broken lines showing books form no part of the claimed design.

1 Claim, 4 Drawing Sheets

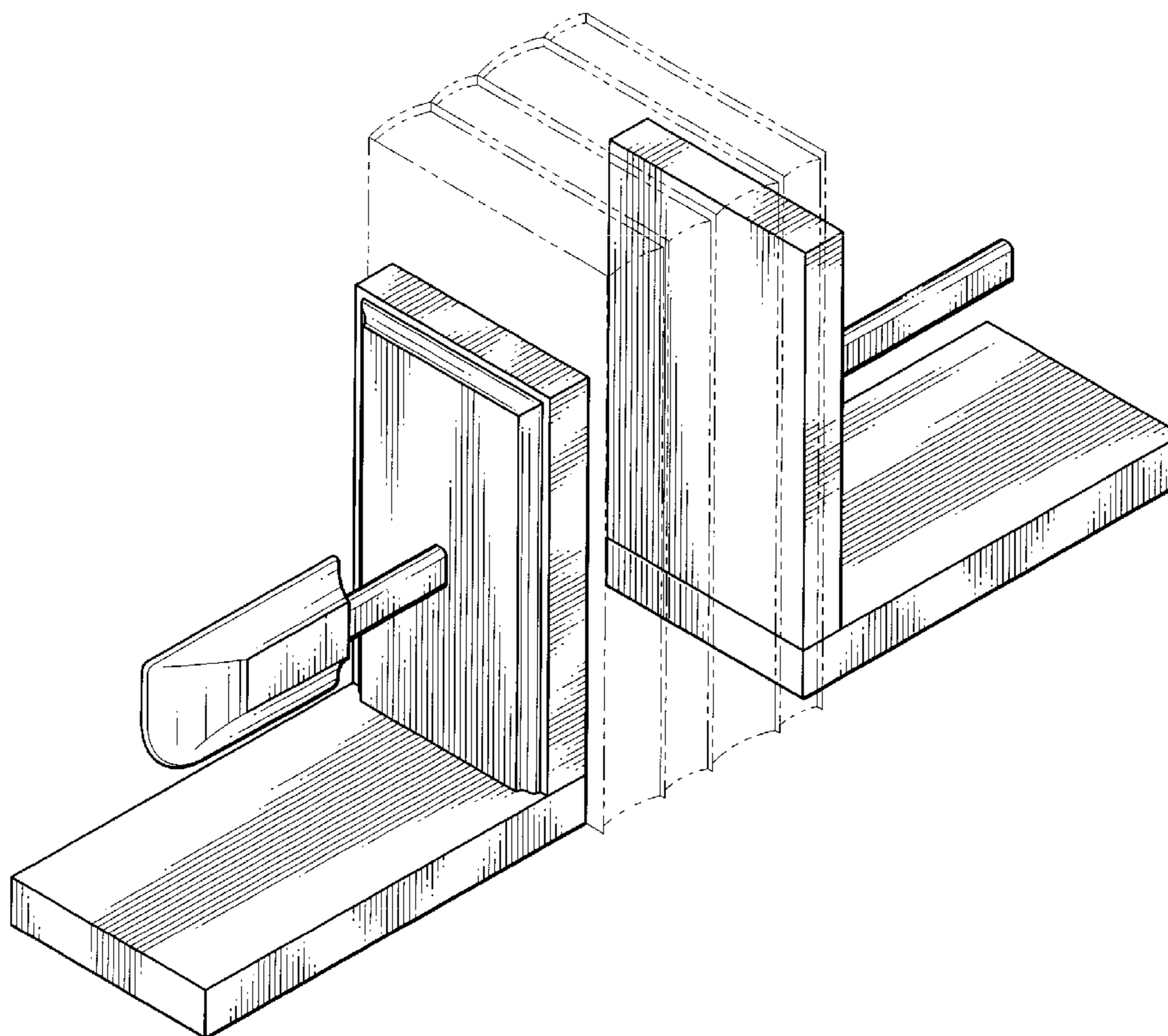

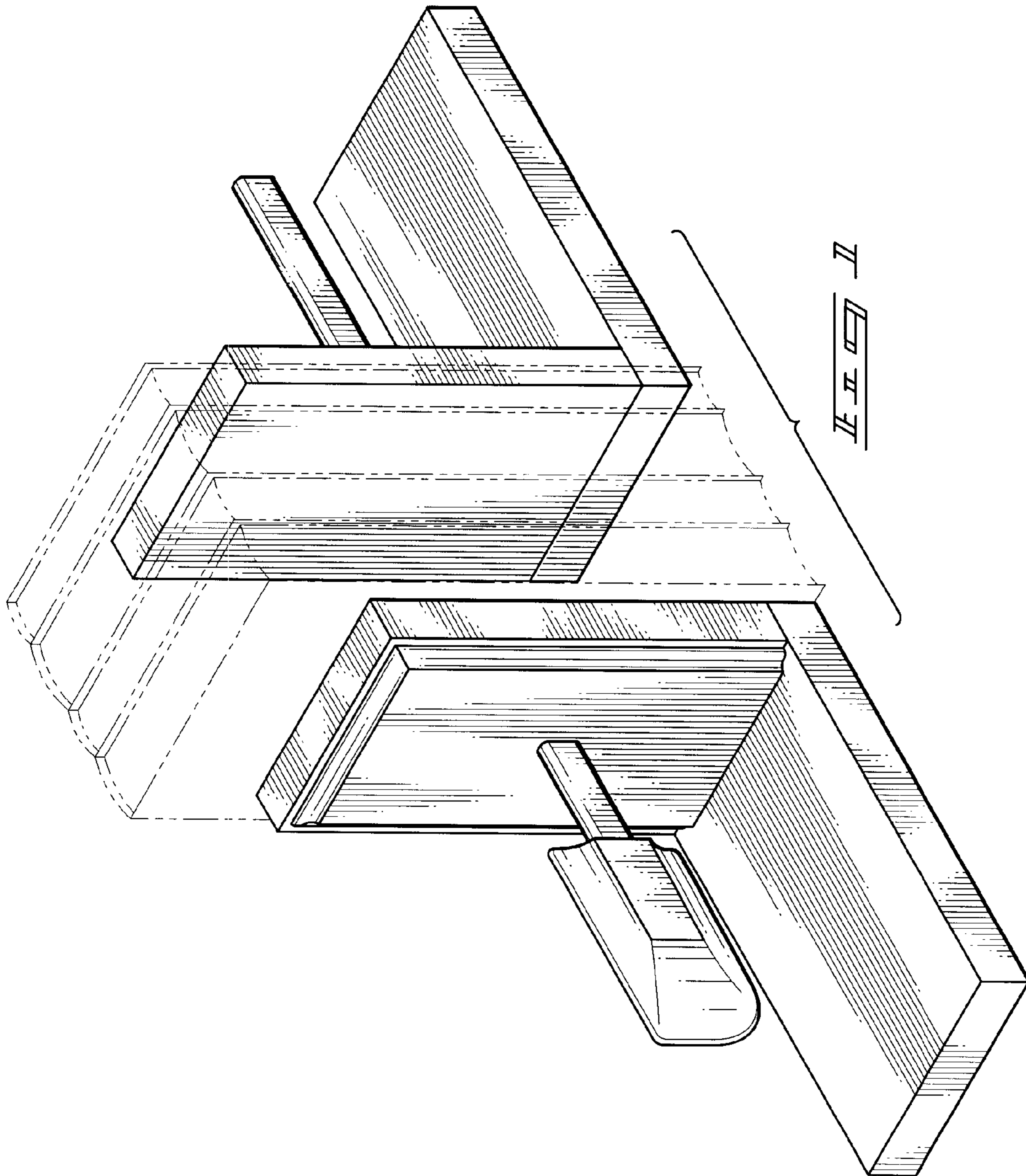

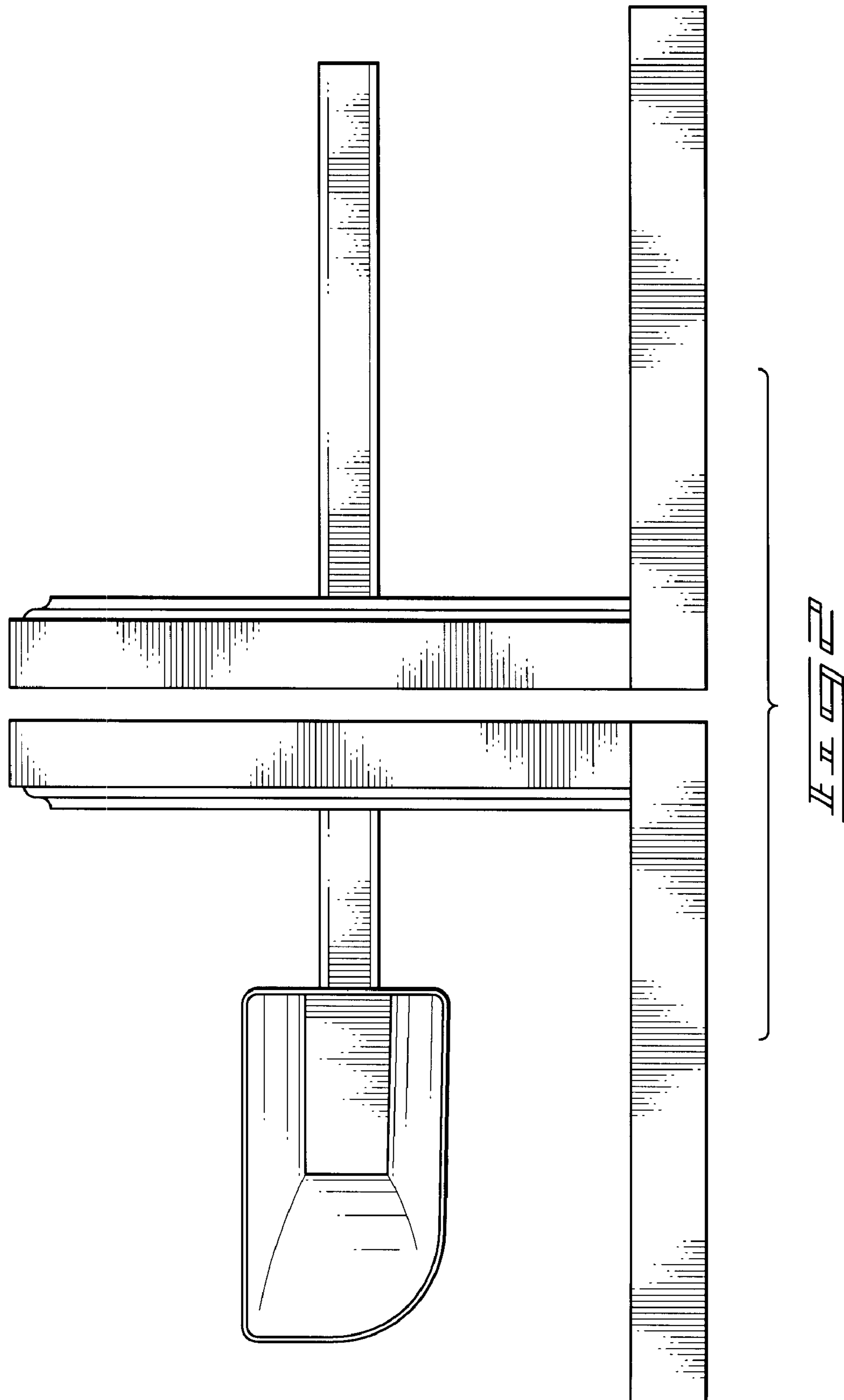

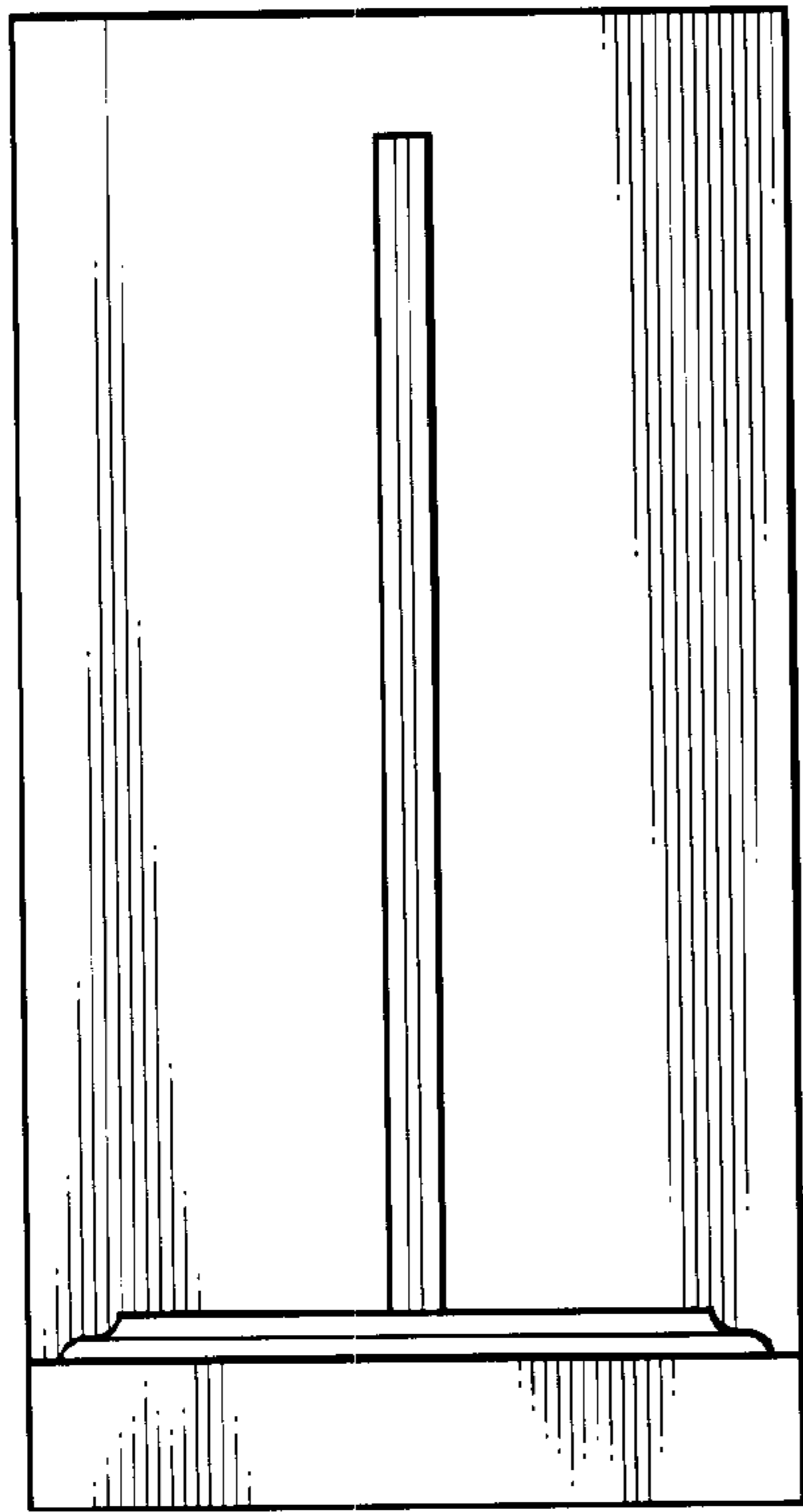

FIG. 1

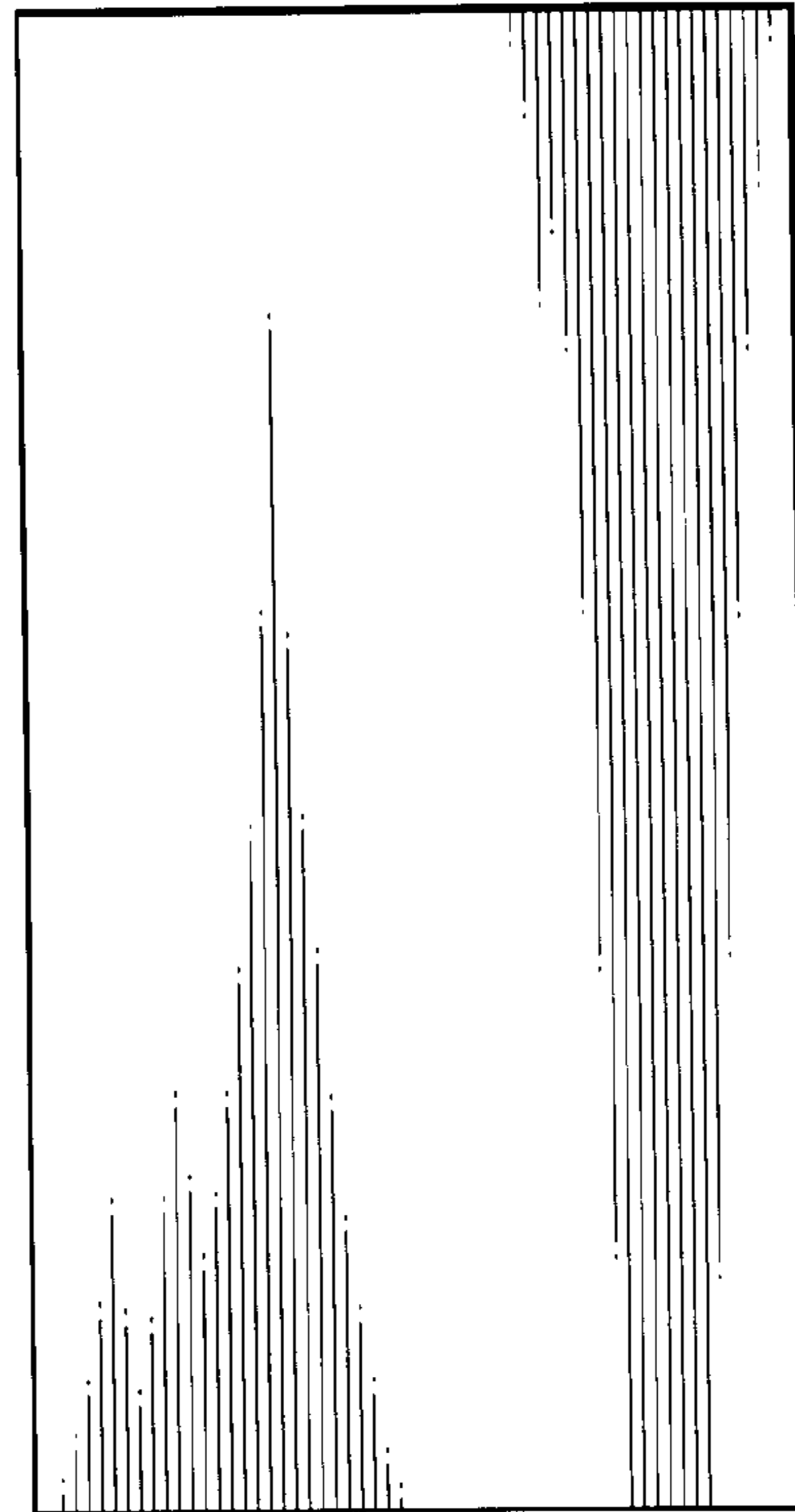
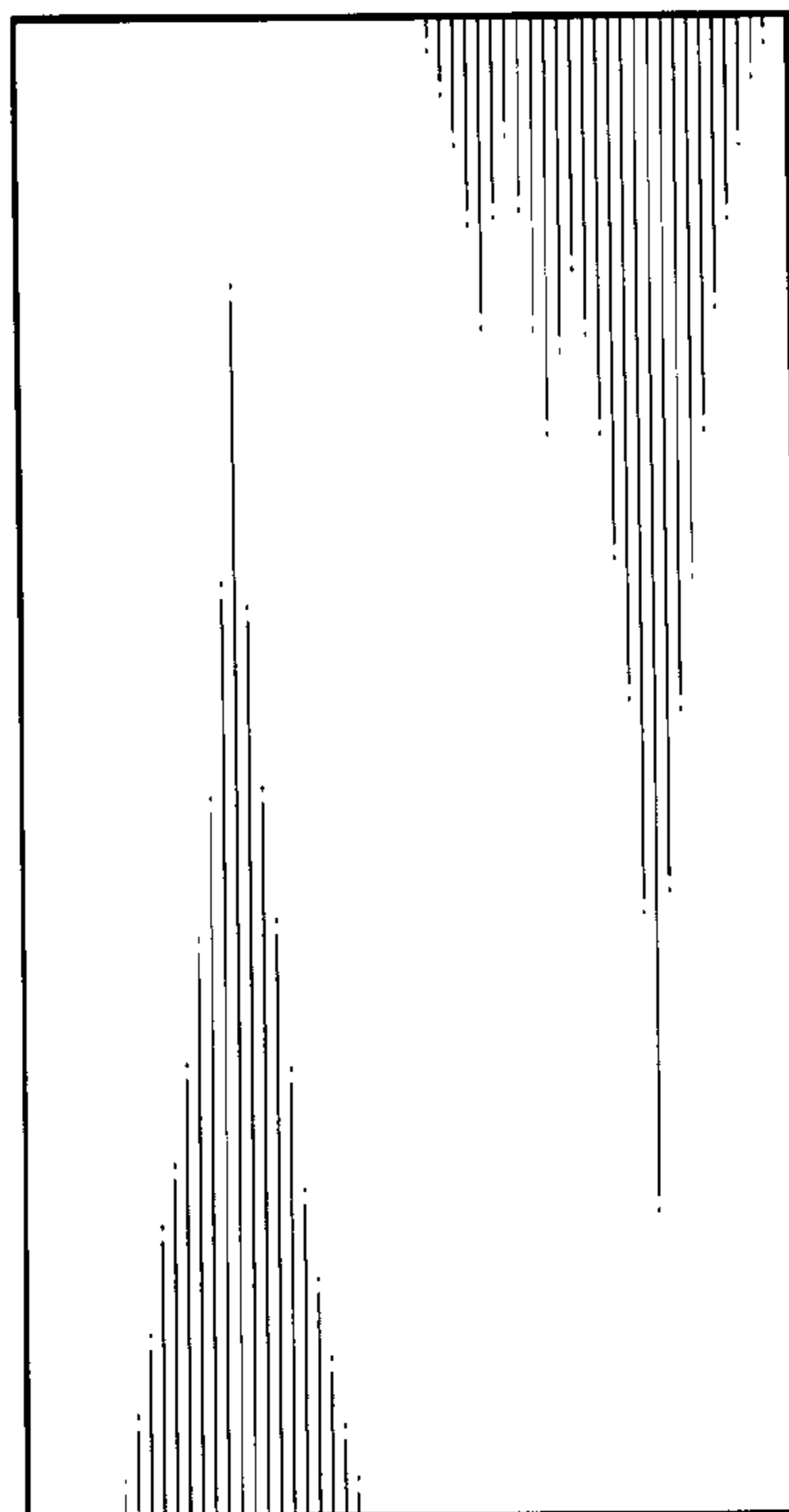
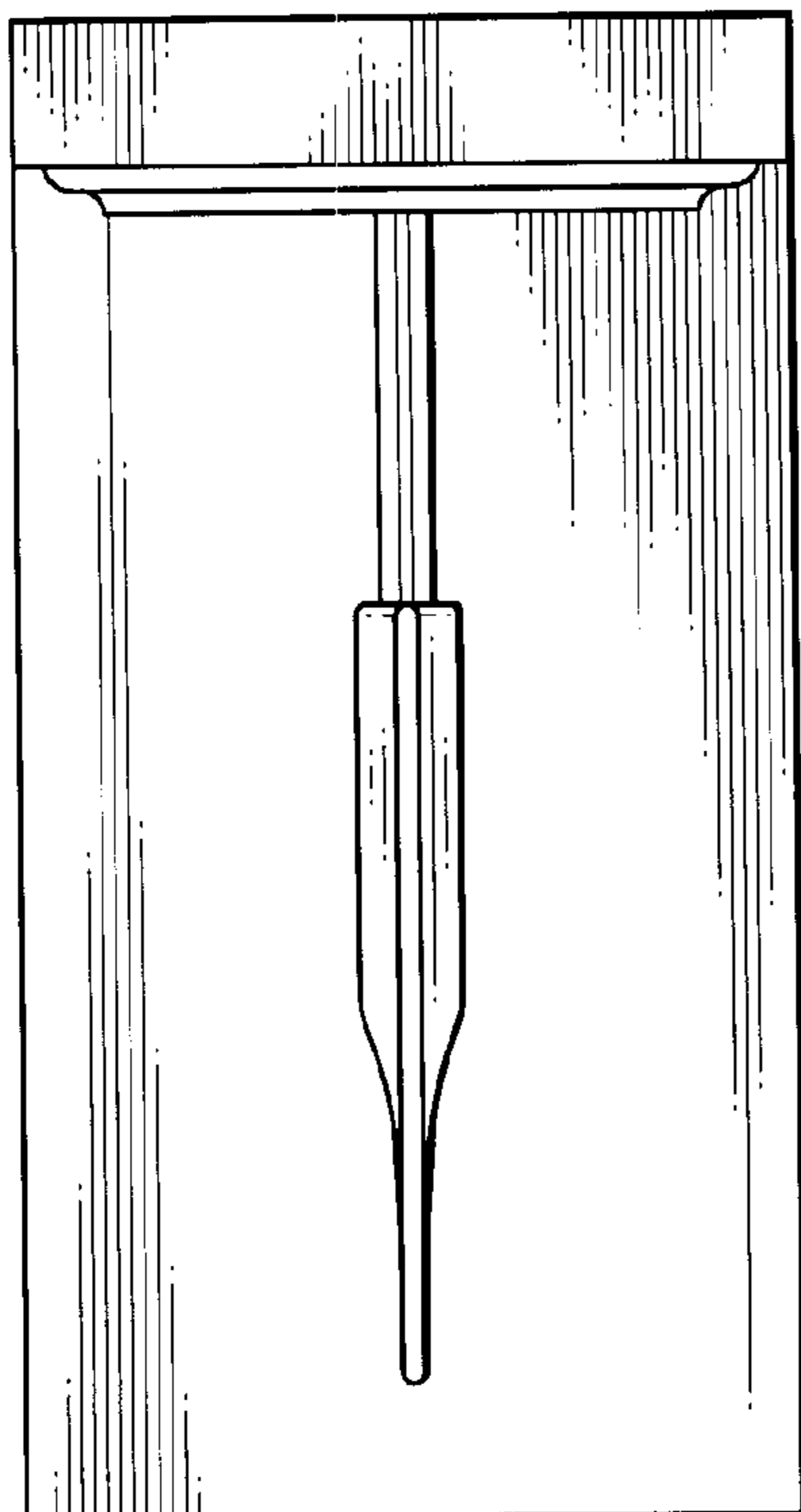

FIG. 2



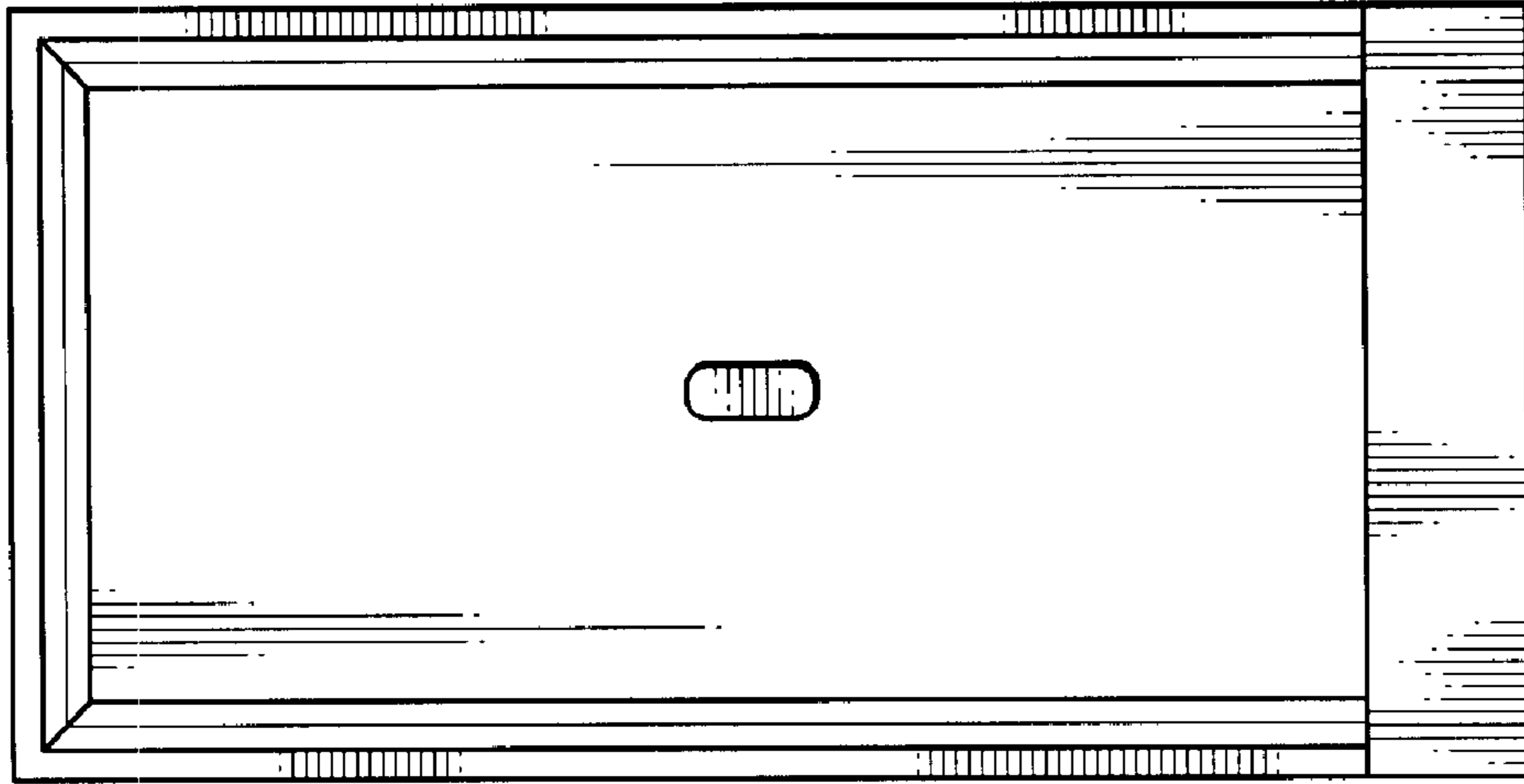

FIG. 4

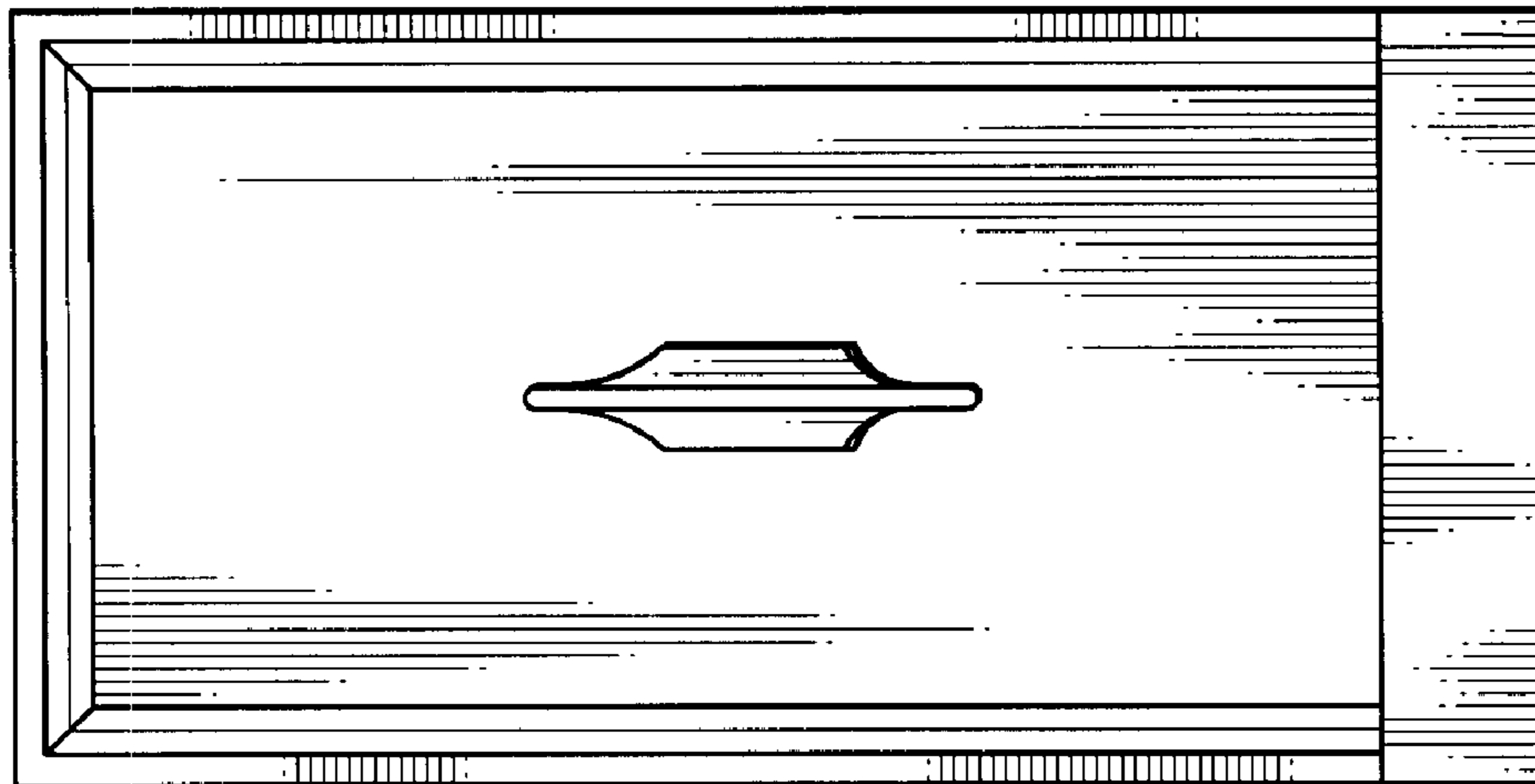

FIG. 5