



US00D532651S

(12) **United States Design Patent**
Giugiaro

(10) **Patent No.:** **US D532,651 S**

(45) **Date of Patent:** **** Nov. 28, 2006**

(54) **HANDLE FOR KITCHEN UTENSIL FOR COOKING AND HEATING OF FOOD**

(75) Inventor: **Fabrizio Giugiaro**, Moncalieri (IT)

(73) Assignee: **TVS S.p.A.**, Trasanni-Urbino (IT)

(**) Term: **14 Years**

(21) Appl. No.: **29/233,326**

(22) Filed: **Jun. 29, 2005**

(30) **Foreign Application Priority Data**

Dec. 30, 2004 (IT) MI2004O0255

(51) **LOC (8) Cl.** **07-02**

(52) **U.S. Cl.** **D7/394**

(58) **Field of Classification Search** D7/354-361,
D7/393-395, 401.2; D8/107, 300, 301, 307;
D4/138, 129; 16/430, 431, 110.1, 407; 220/573.1-573.5,
220/752, 753, 755, 756, 912

See application file for complete search history.

(56) **References Cited**

U.S. PATENT DOCUMENTS

D395,376 S * 6/1998 Montgelard D7/393

D461,094 S * 8/2002 Coudurier D7/394

D462,570 S * 9/2002 Munari D7/394

D465,129 S * 11/2002 Klock et al. D7/393

D470,011 S * 2/2003 Munari D7/394

D508,370 S * 8/2005 Cuillery D7/394

* cited by examiner

Primary Examiner—Holly Baynham

Assistant Examiner—Cynthia M. Chin

(74) *Attorney, Agent, or Firm*—Abelman, Frayne & Schwab

(57) **CLAIM**

The ornamental design for a handle for kitchen utensil for cooking and heating of food, as shown and described.

DESCRIPTION

FIG. 1 is a top front left side perspective view of a handle for kitchen utensil for cooking and heating of food showing my new design;

FIG. 2 is a left side elevational view thereof;

FIG. 3 is a front elevational view thereof;

FIG. 4 is a top plan view thereof;

FIG. 5 is a rear elevational view thereof;

FIG. 6 is a right side elevational view thereof; and,

FIG. 7 is a bottom plan view thereof.

1 Claim, 2 Drawing Sheets

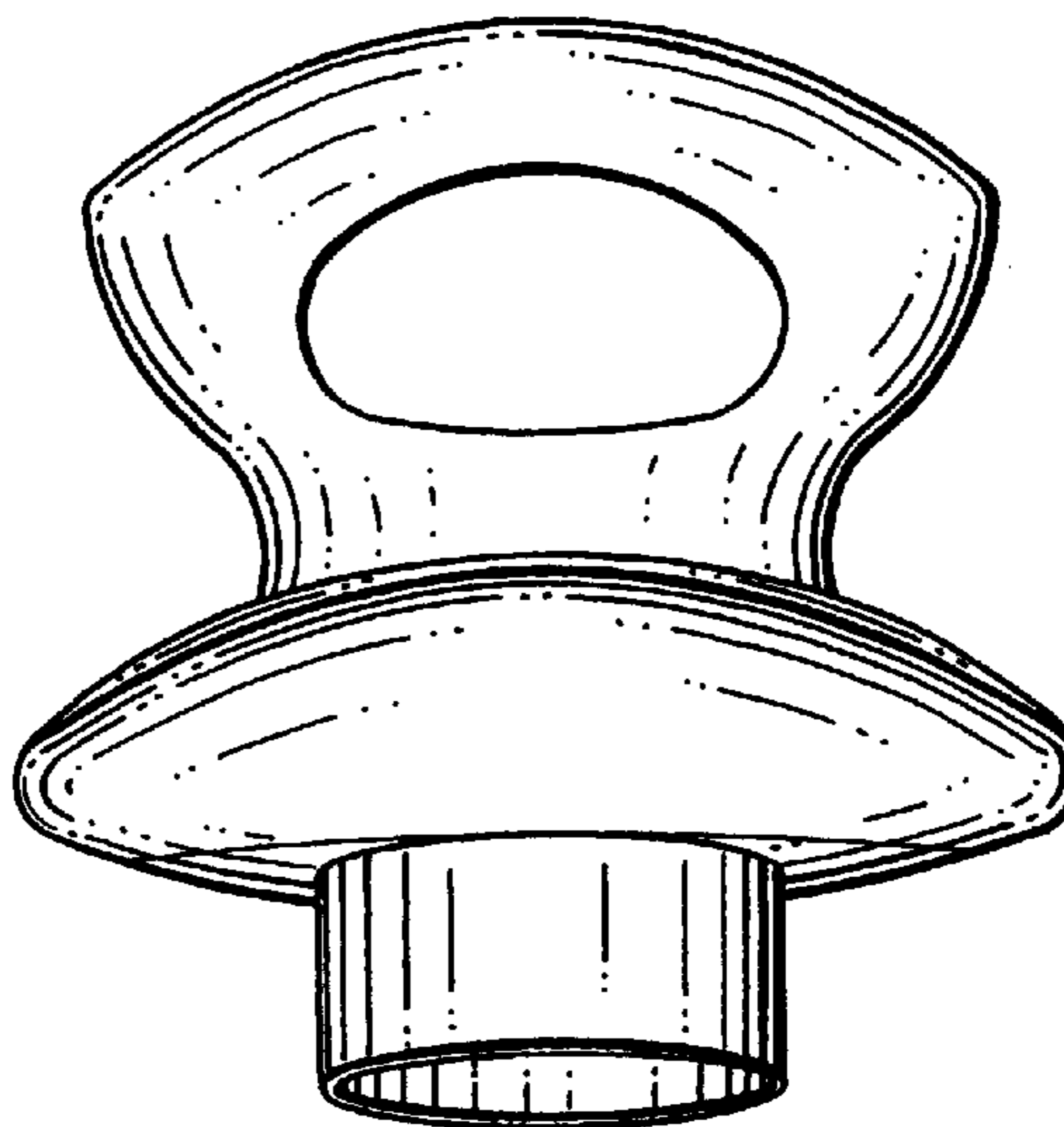
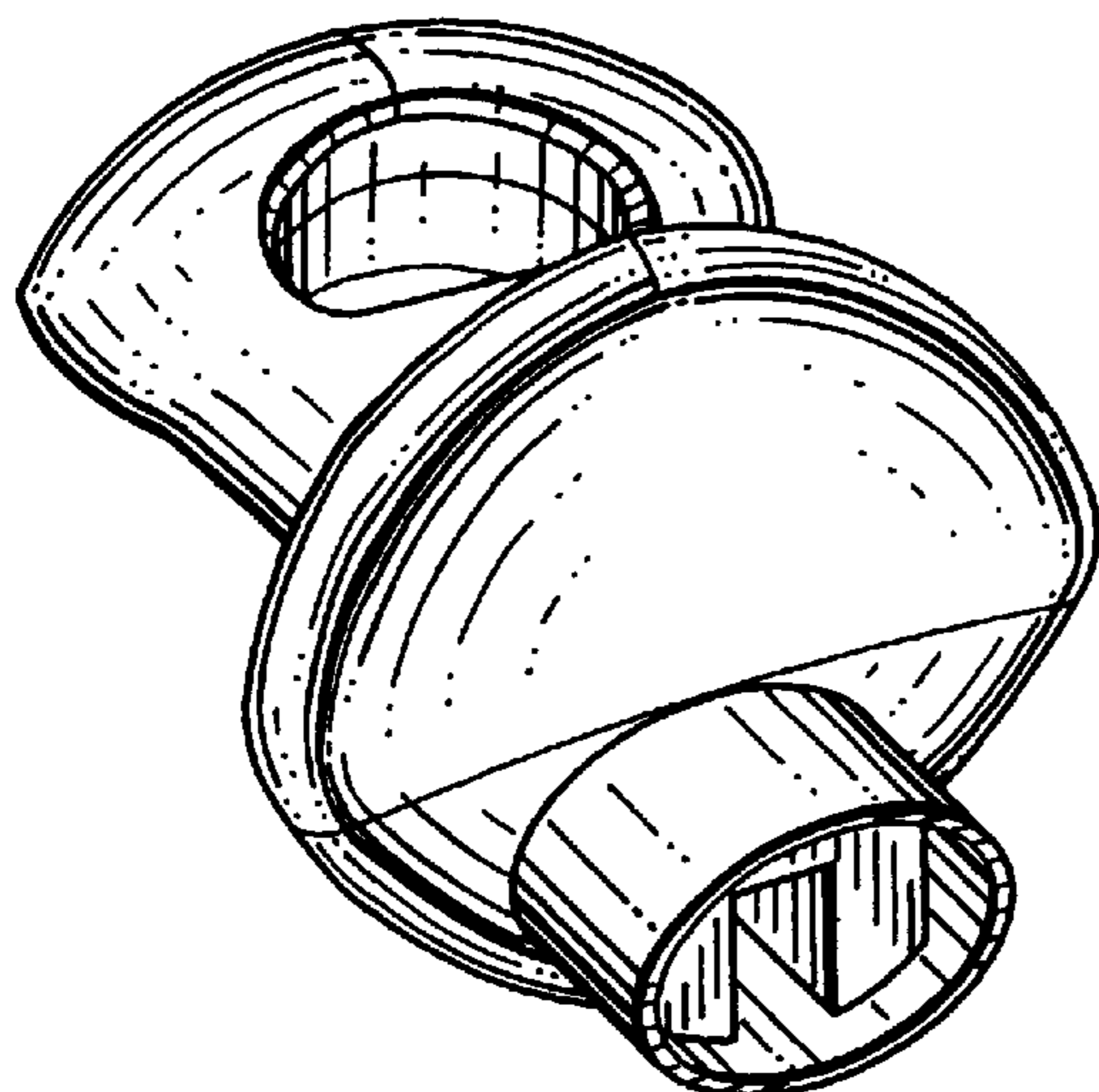

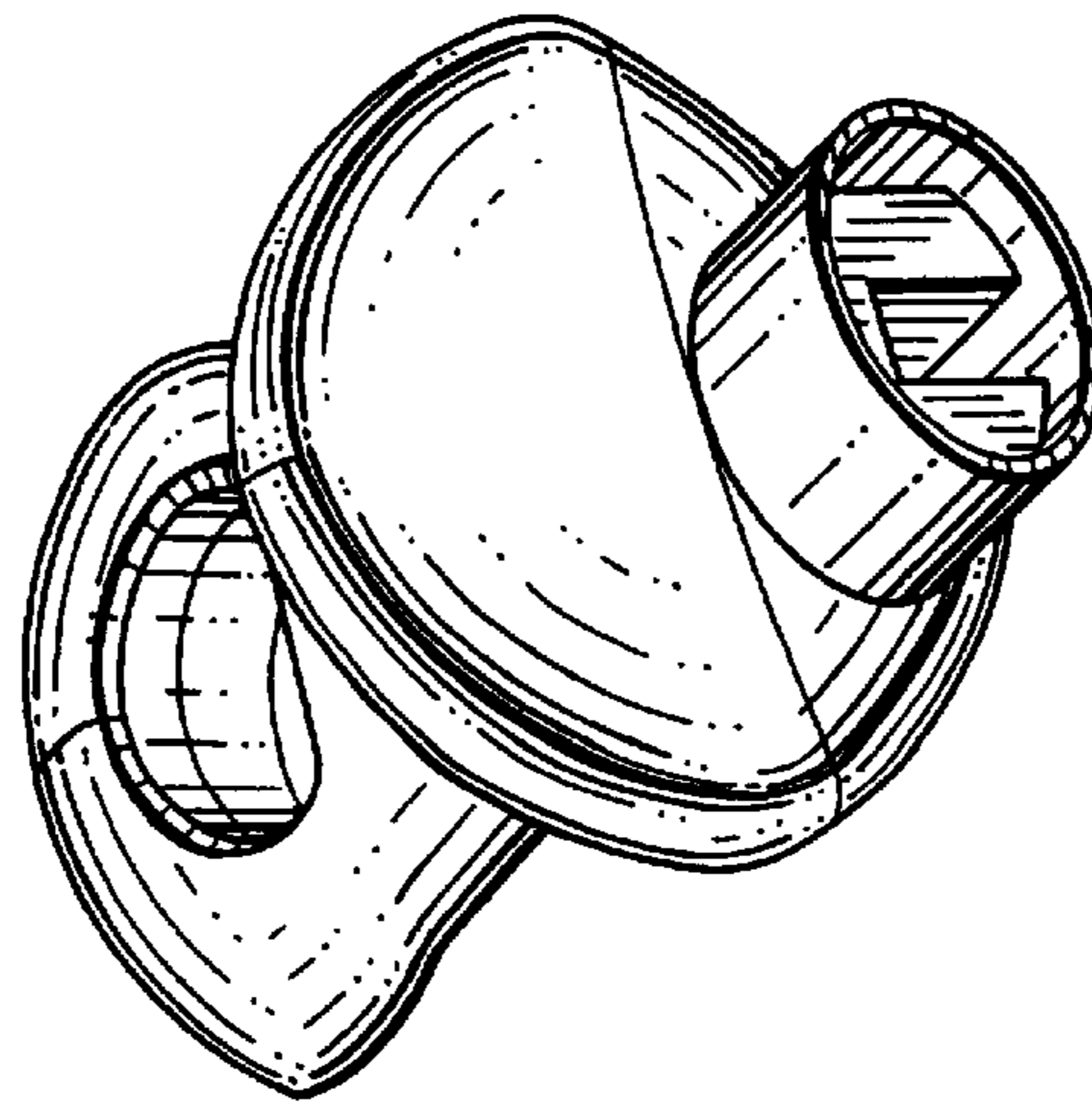

Fig. 1

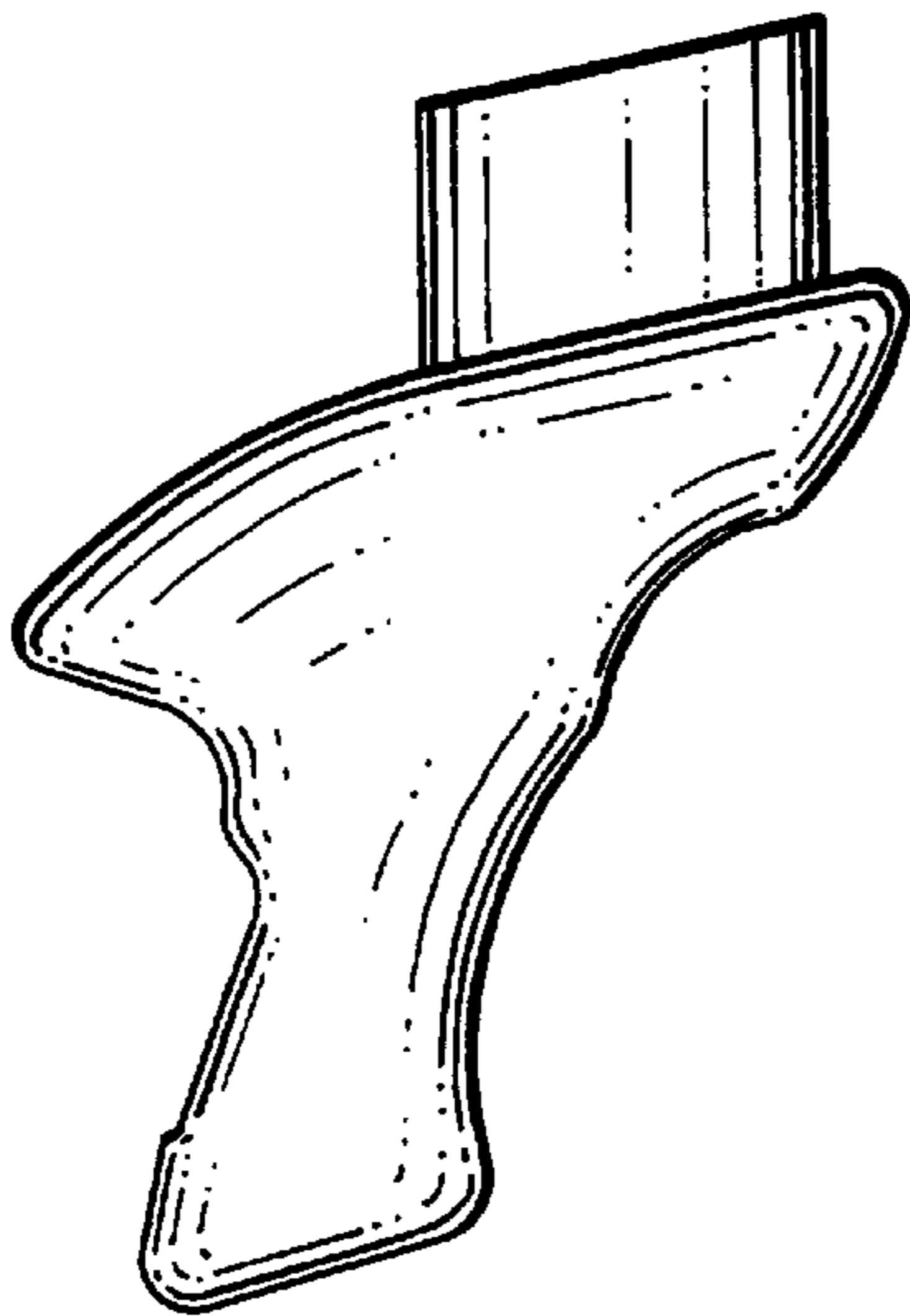

Fig. 2

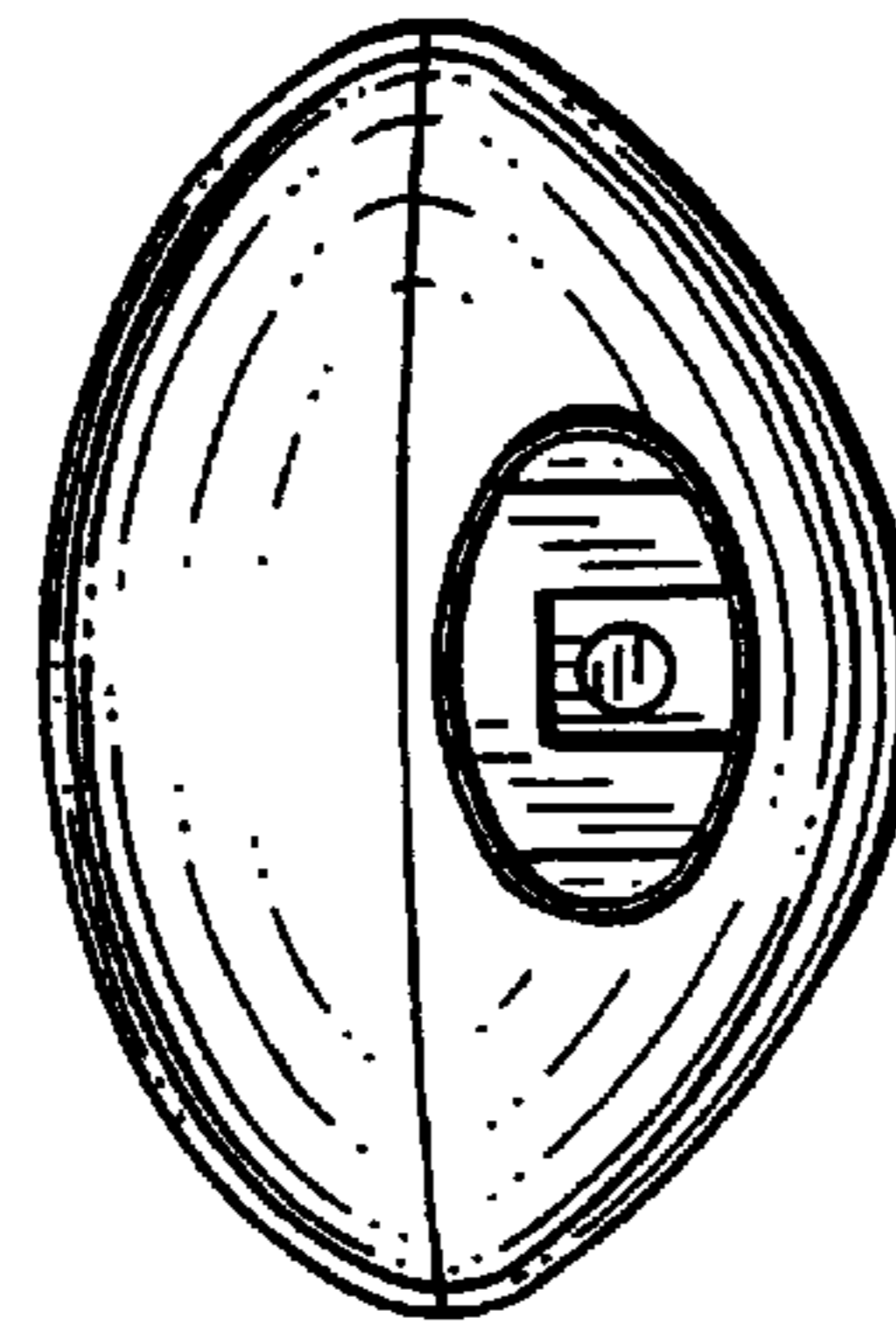

Fig. 3

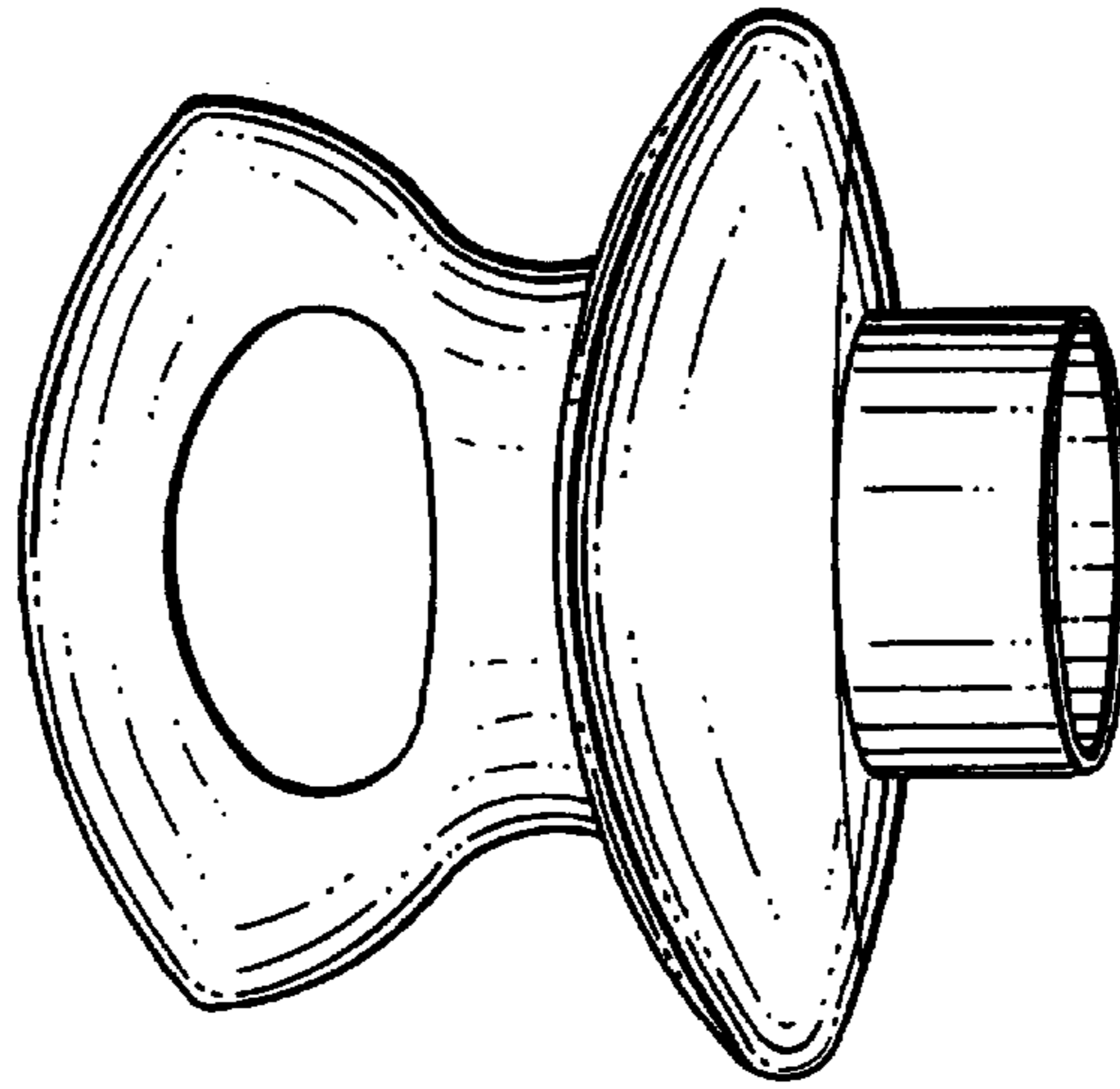

Fig. 4

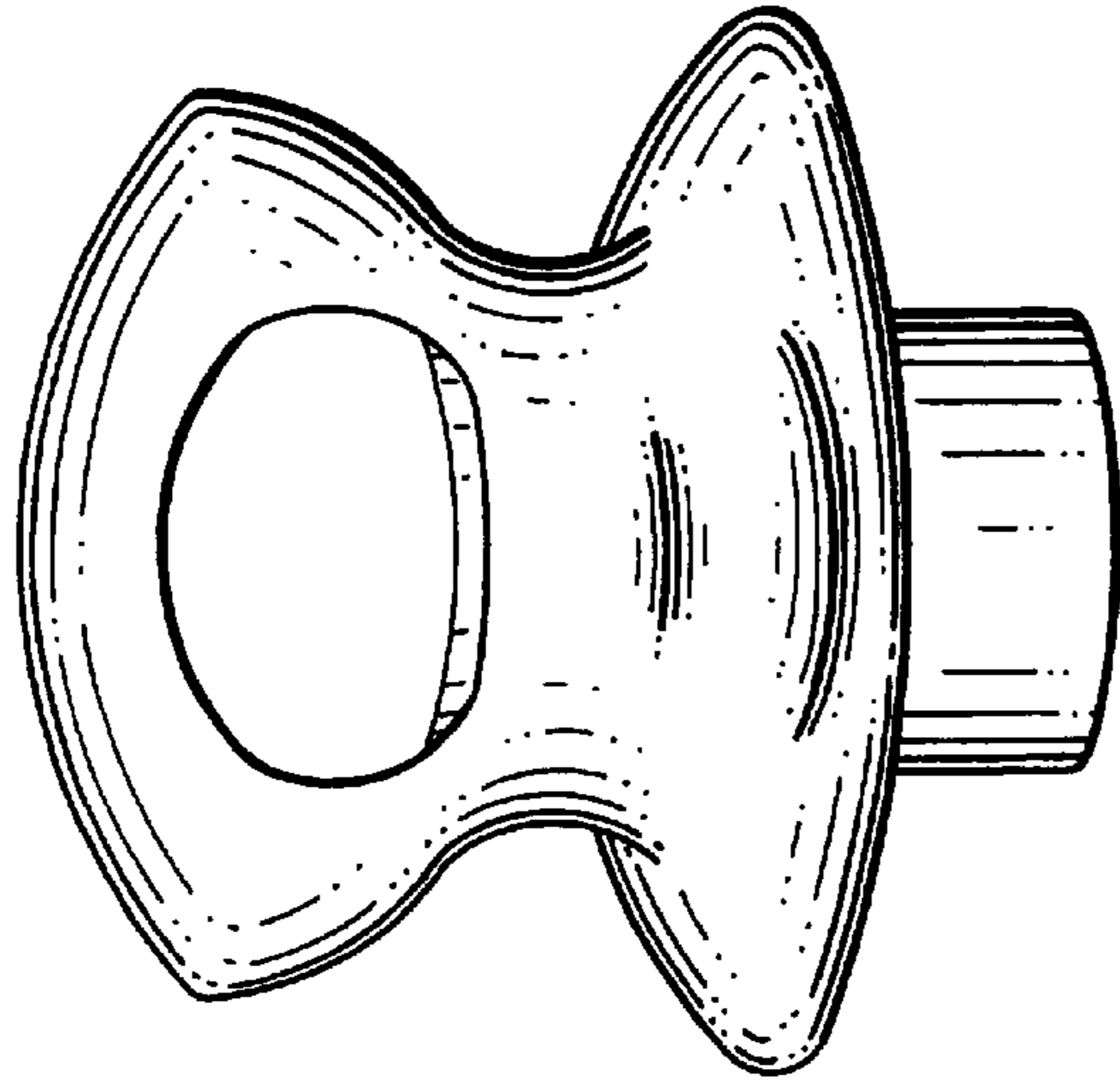

Fig.7

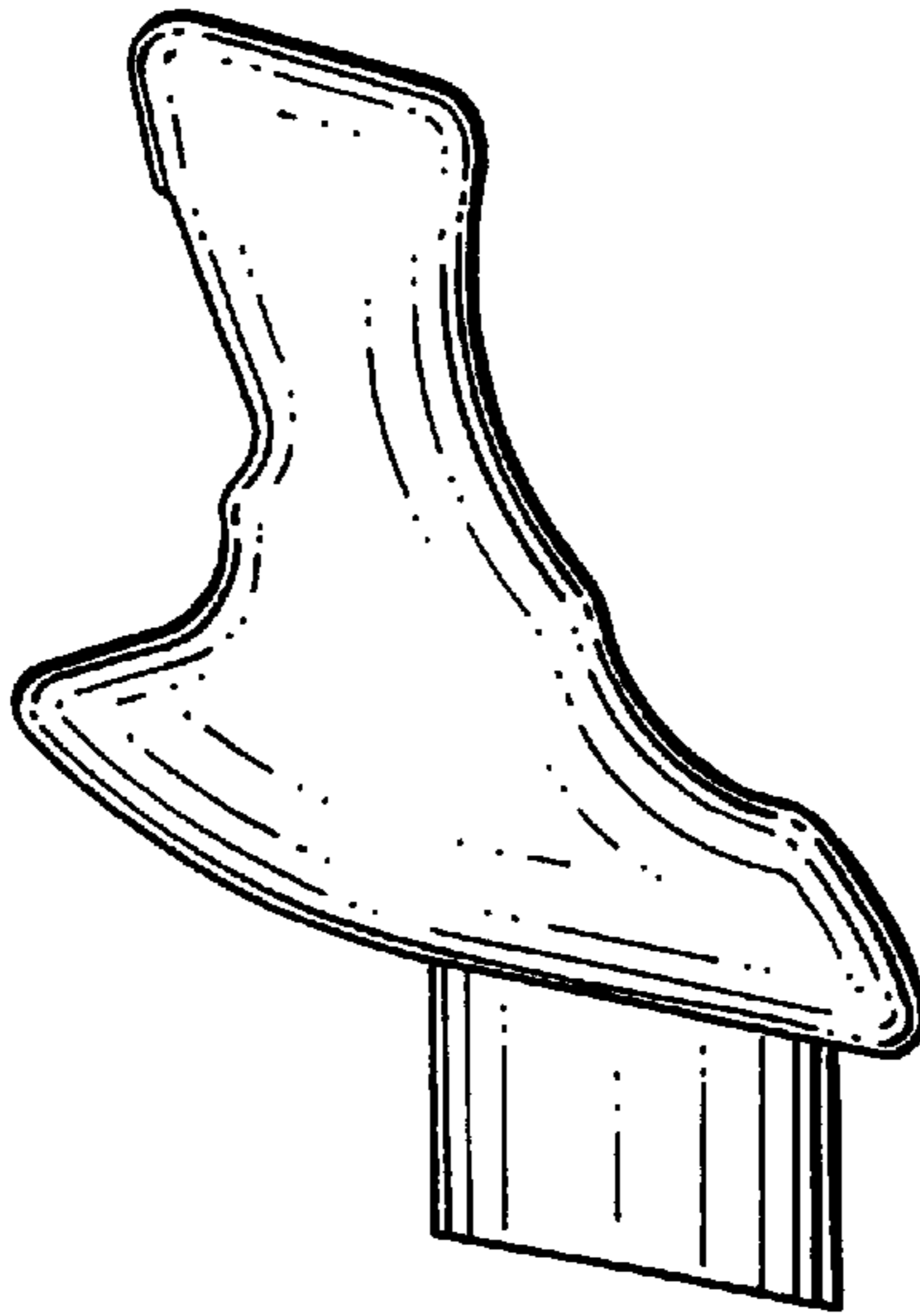

Fig.6

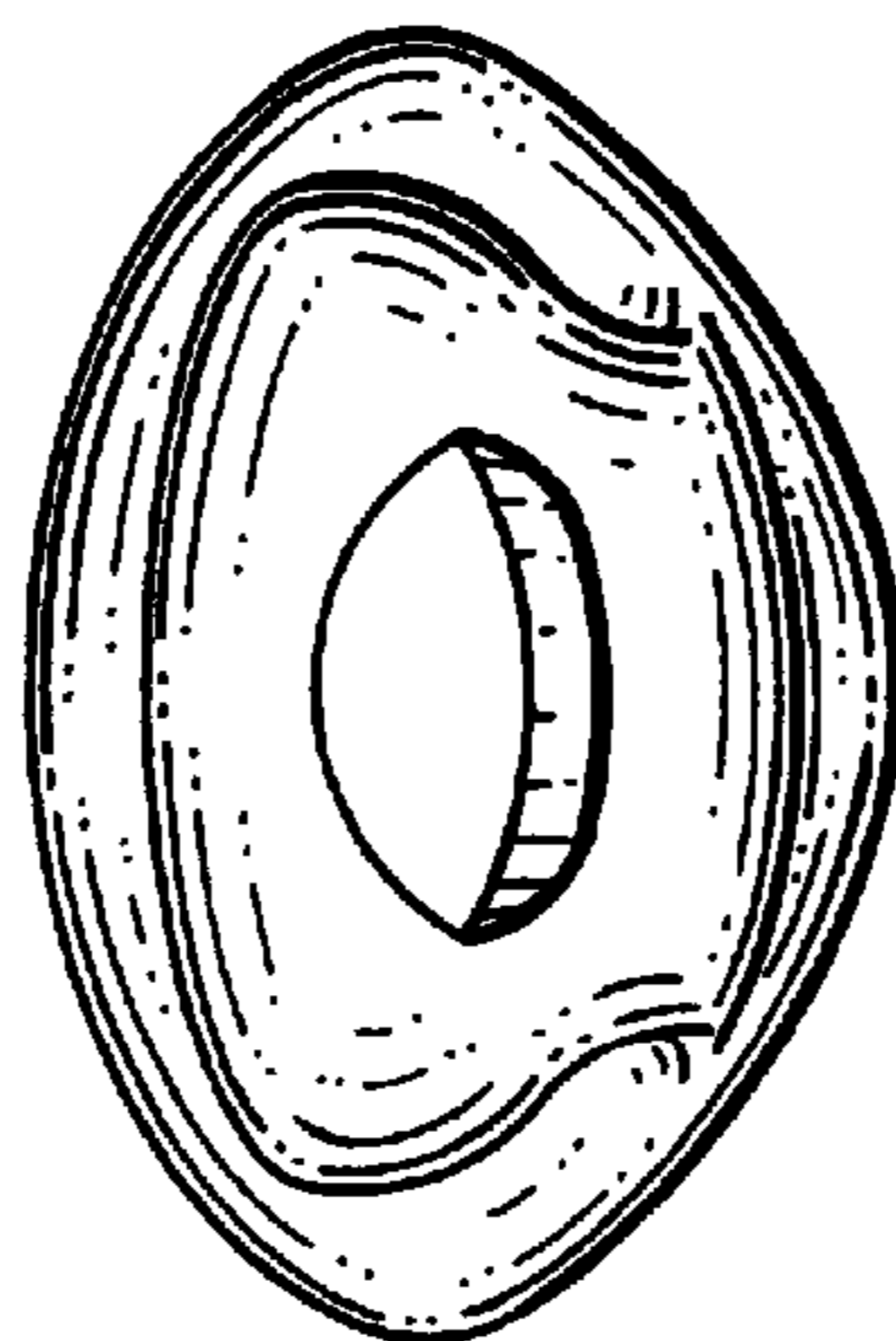

Fig.5