



US00D532556S

(12) **United States Design Patent**  
**Noh**

(10) **Patent No.:** **US D532,556 S**

(45) **Date of Patent:** **\*\* Nov. 21, 2006**

(54) **COSMETIC CONTAINER**

(75) Inventor: **Byong Hoo Noh**, Seoul (KR)

(73) Assignee: **Saint Coree International Co., Ltd.**,  
Gunpo-si (KR)

(\*\*) Term: **14 Years**

(21) Appl. No.: **29/235,031**

(22) Filed: **Jul. 27, 2005**

(51) **LOC (8) Cl.** ..... **28-03**

(52) **U.S. Cl.** ..... **D28/76; D9/725; D9/504**

(58) **Field of Classification Search** ..... D28/76-82,  
D28/85, 88-89, 91; 401/130, 266; 132/293-307,  
132/317, 318, 320; D9/503-505, 529, 723,  
D9/725, 727; 206/581, 823

See application file for complete search history.

(56) **References Cited**

**U.S. PATENT DOCUMENTS**

4,832,060	A	*	5/1989	Kingsford	.....	132/293
D485,017	S	*	1/2004	Noh	.....	D28/76
D493,721	S	*	8/2004	Puigbo	.....	D9/504
D499,648	S	*	12/2004	Lewis et al.	.....	D9/504
D504,542	S	*	4/2005	Noh	.....	D28/76

D509,434	S	*	9/2005	Haruta	.....	D9/504
2003/0041872	A1	*	3/2003	Noa	.....	132/320
2004/0035438	A1	*	2/2004	Hwang et al.	.....	132/299
2005/0011895	A1	*	1/2005	Lin	.....	132/293
2005/0092343	A1	*	5/2005	Byun	.....	132/293

\* cited by examiner

*Primary Examiner*—Jennifer Rivard

(74) *Attorney, Agent, or Firm*—Birch, Stewart, Kolasch & Birch, LLP

(57) **CLAIM**

The ornamental design for a cosmetic container, as shown and described.

**DESCRIPTION**

FIG. 1 is a perspective view of a cosmetic container showing my new design;

FIG. 2 is a front elevational view thereof;

FIG. 3 is a rear elevational view thereof;

FIG. 4 is a left side elevational view thereof;

FIG. 5 is a right side elevational view thereof;

FIG. 6 is a top plan view thereof;

FIG. 7 is a bottom plan view thereof; and,

FIG. 8 is a perspective view thereof in an open state.

**1 Claim, 5 Drawing Sheets**

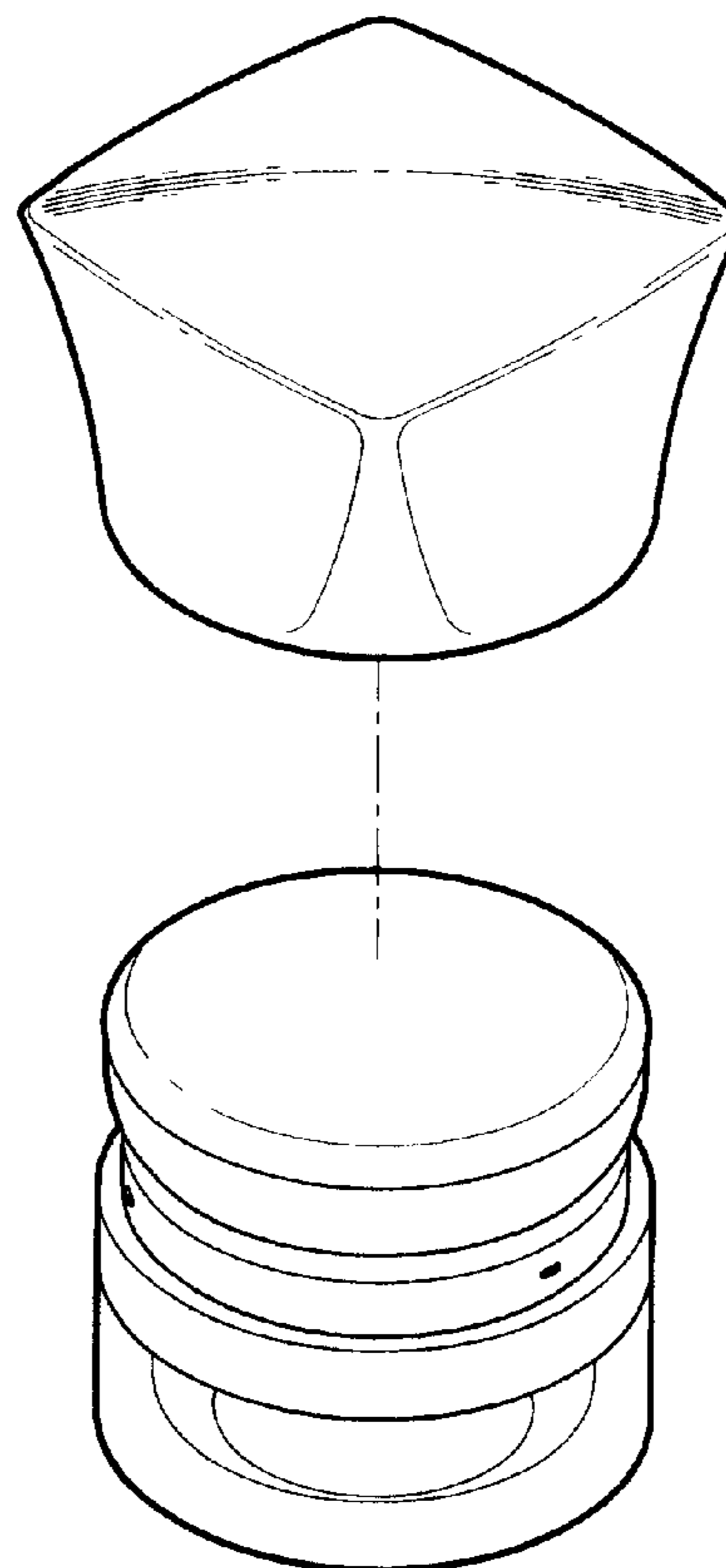
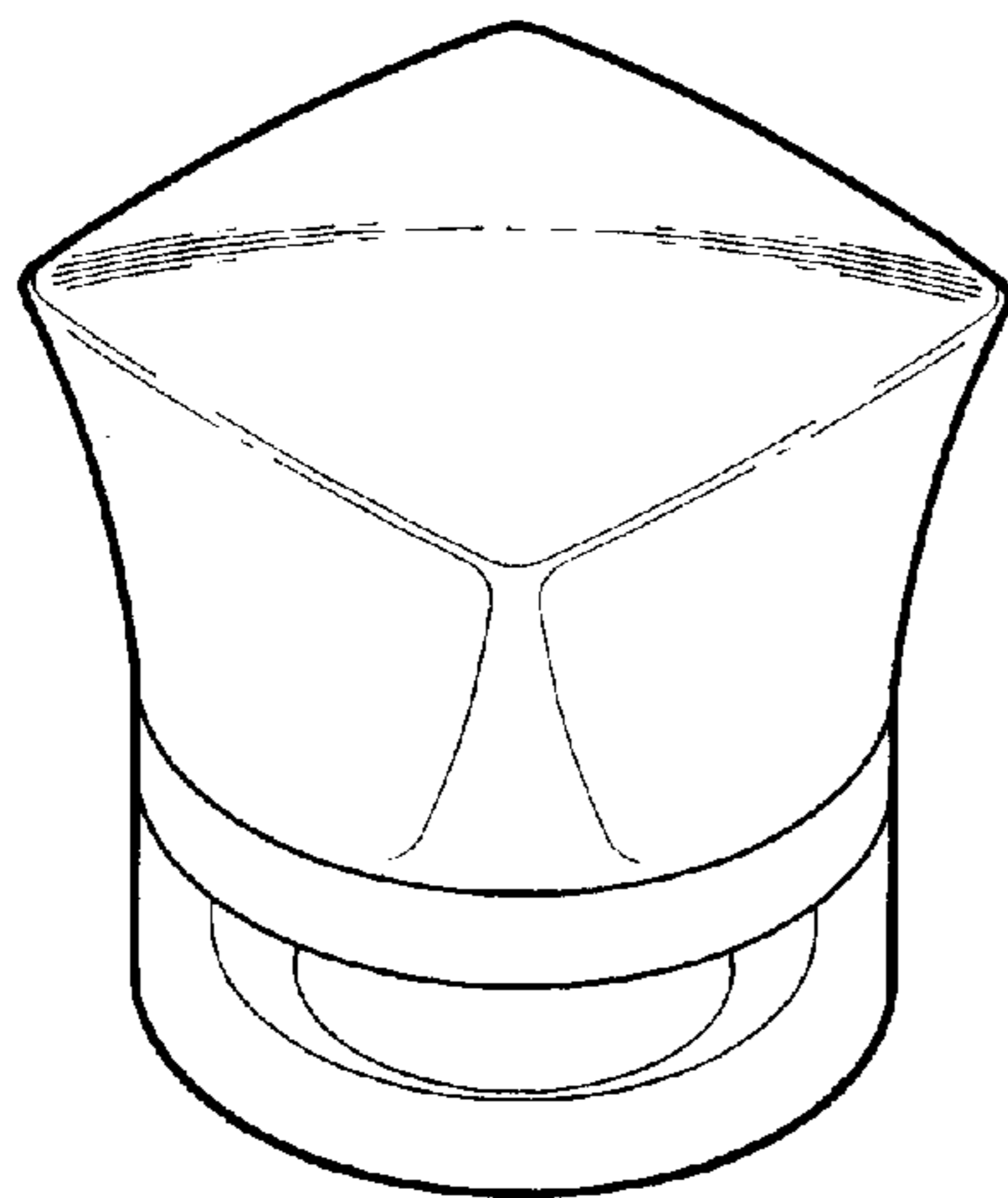

FIG. 1

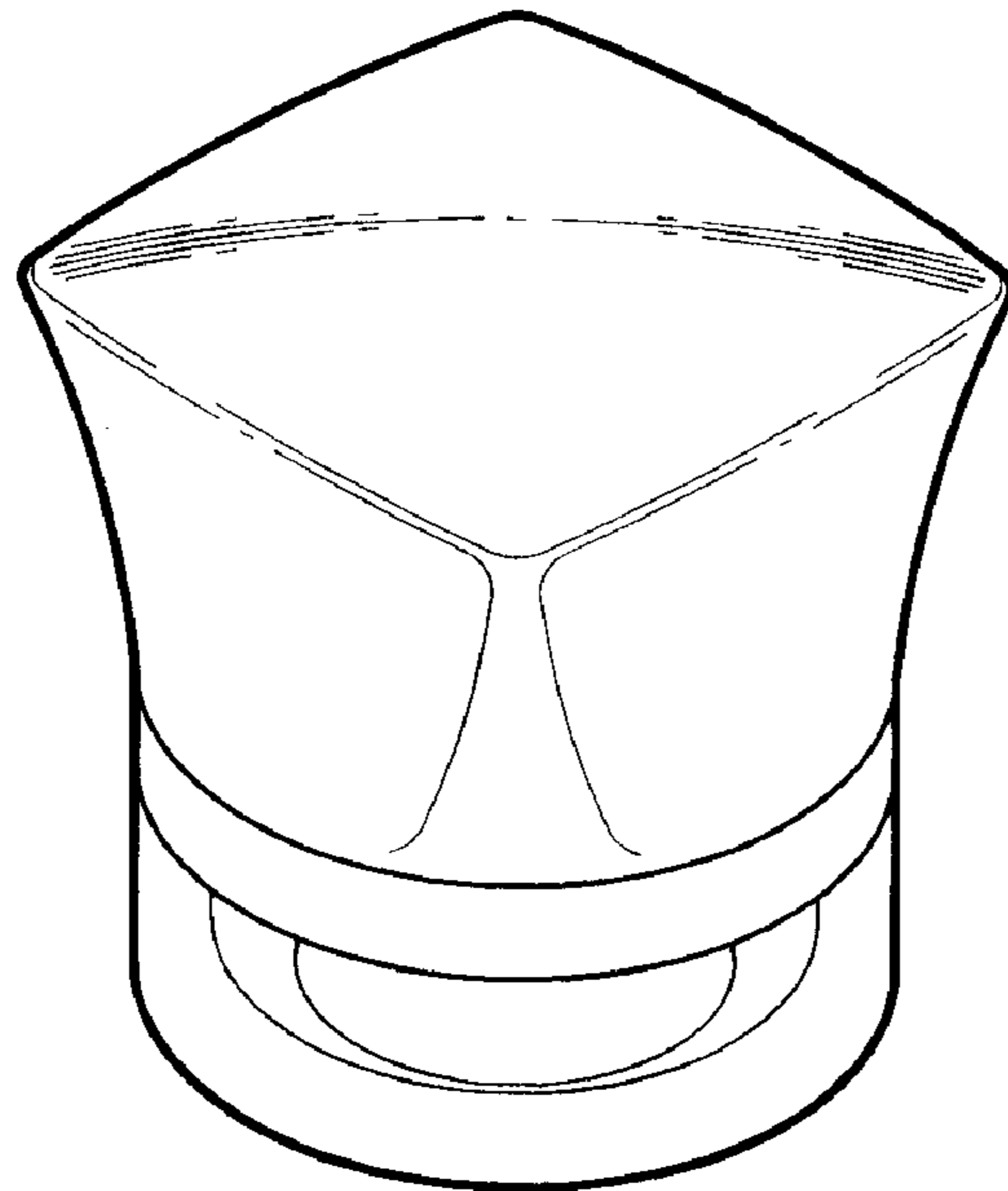

FIG. 2

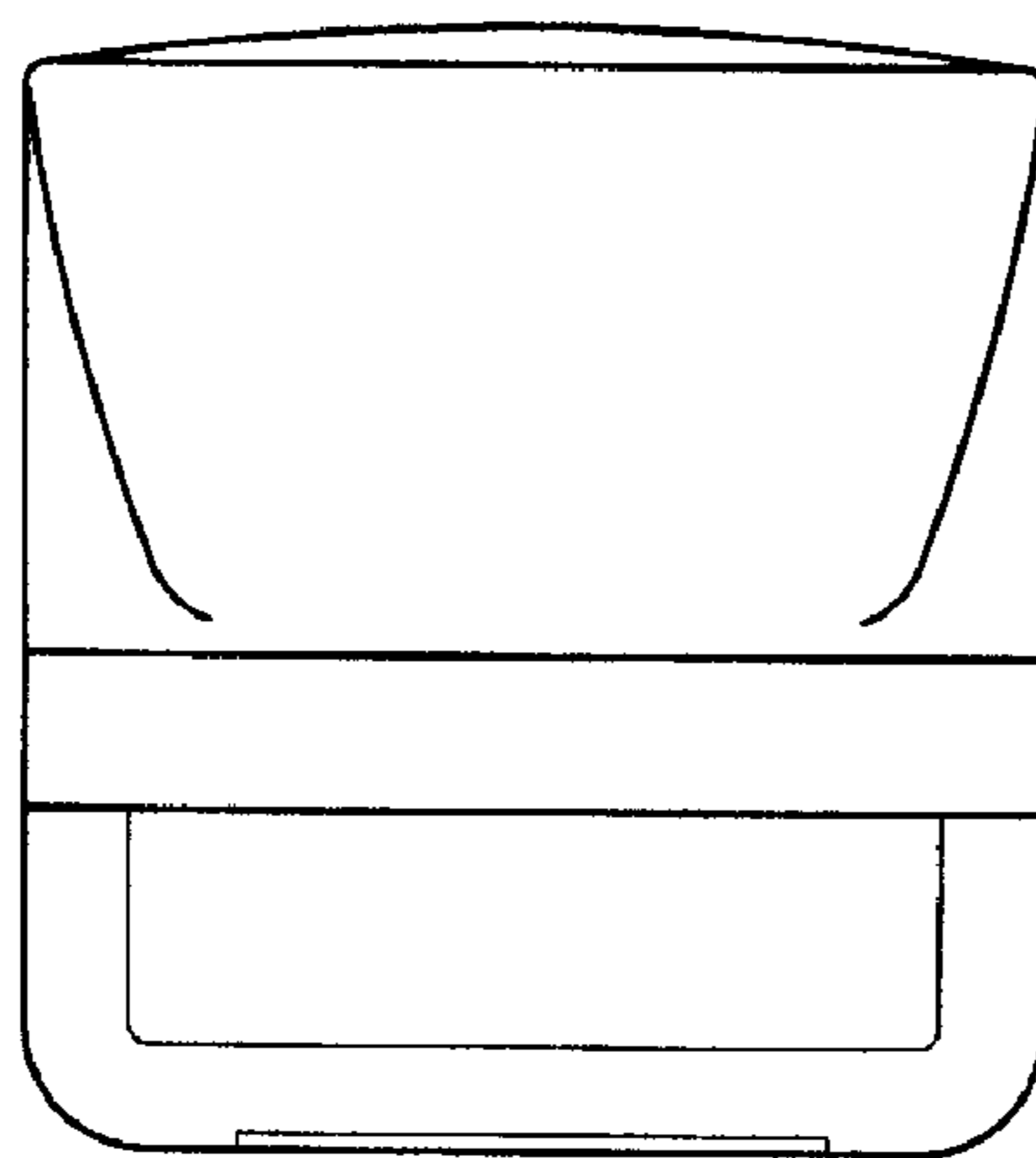

FIG. 3

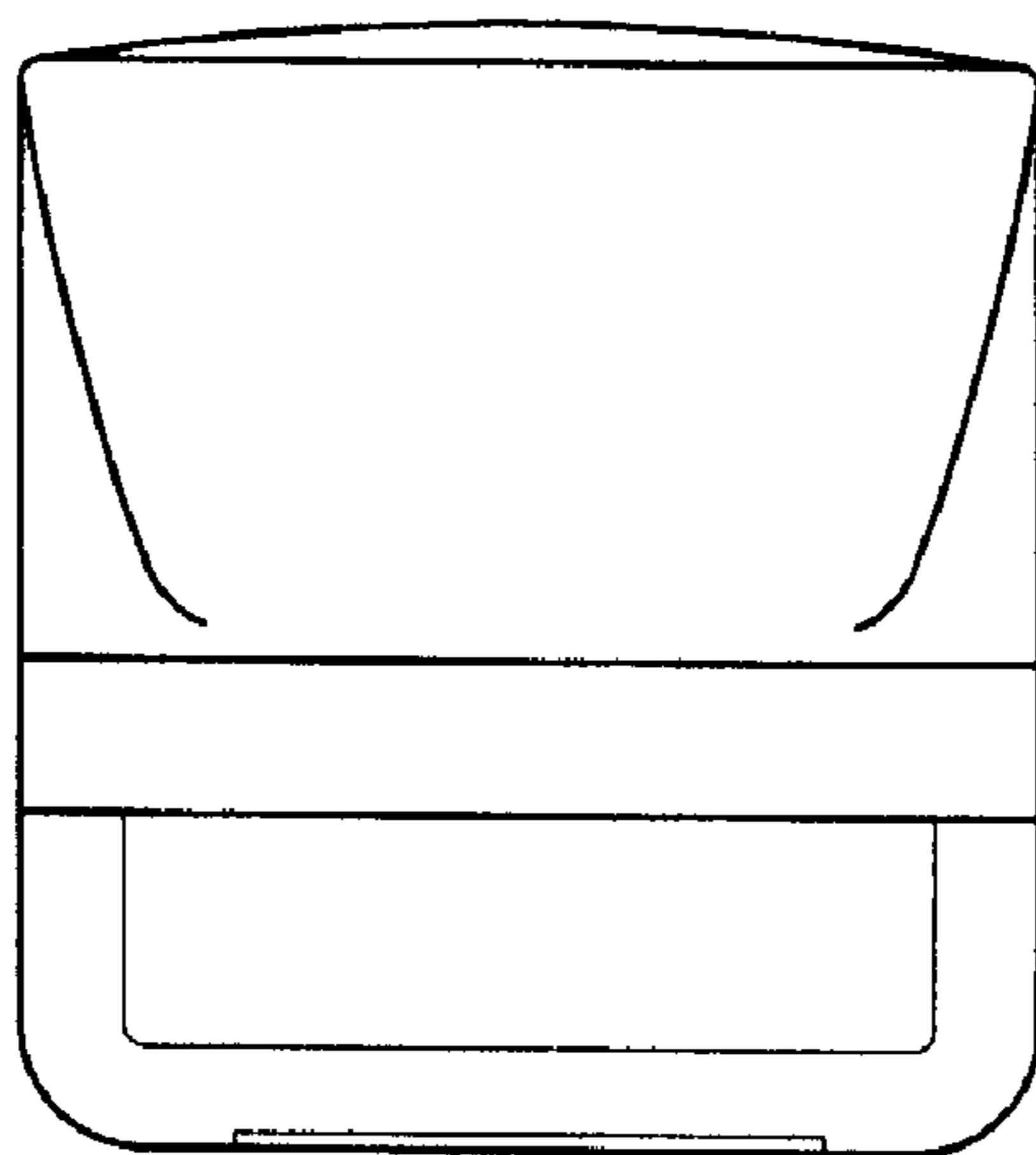

FIG. 4

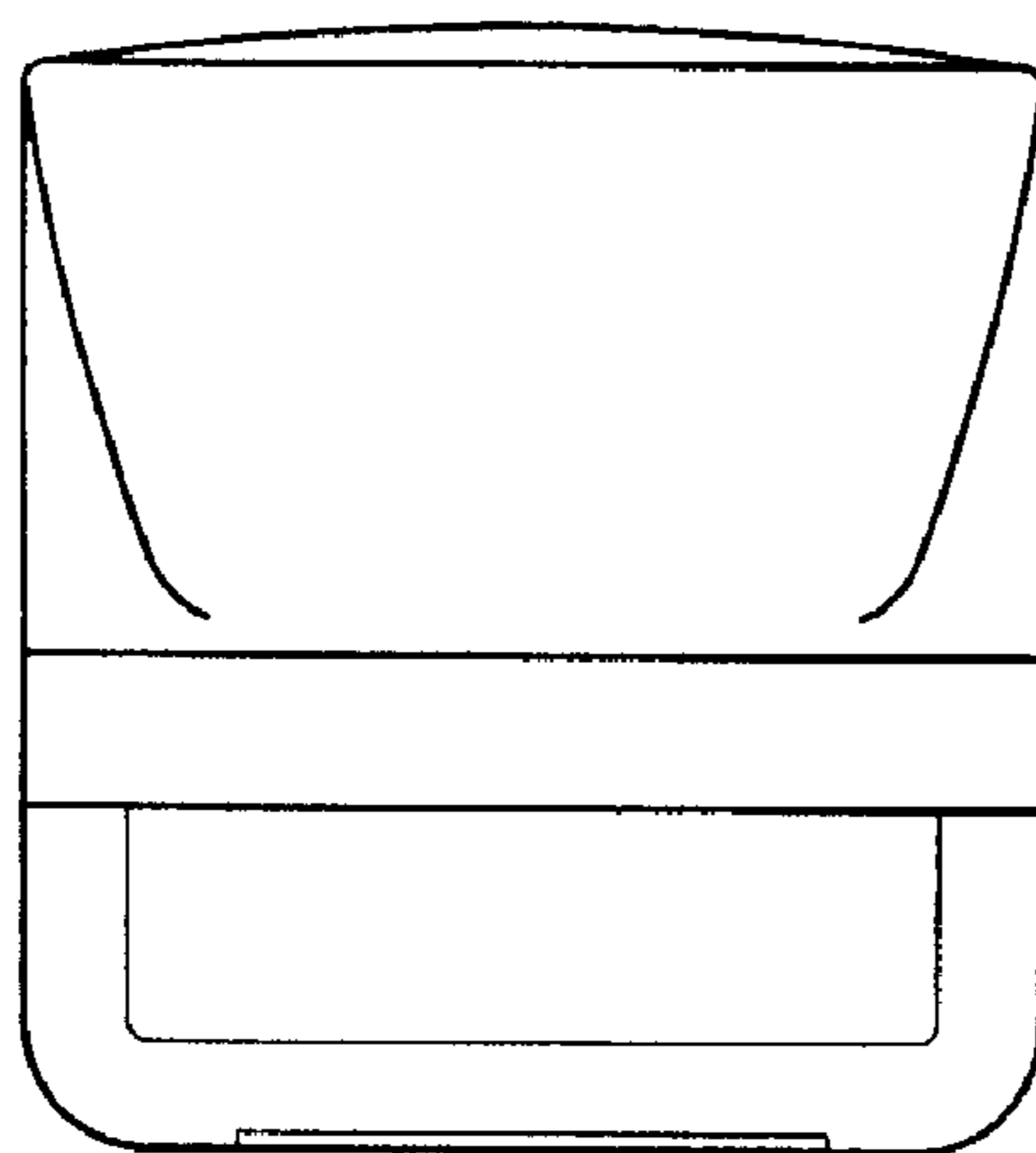

FIG. 5

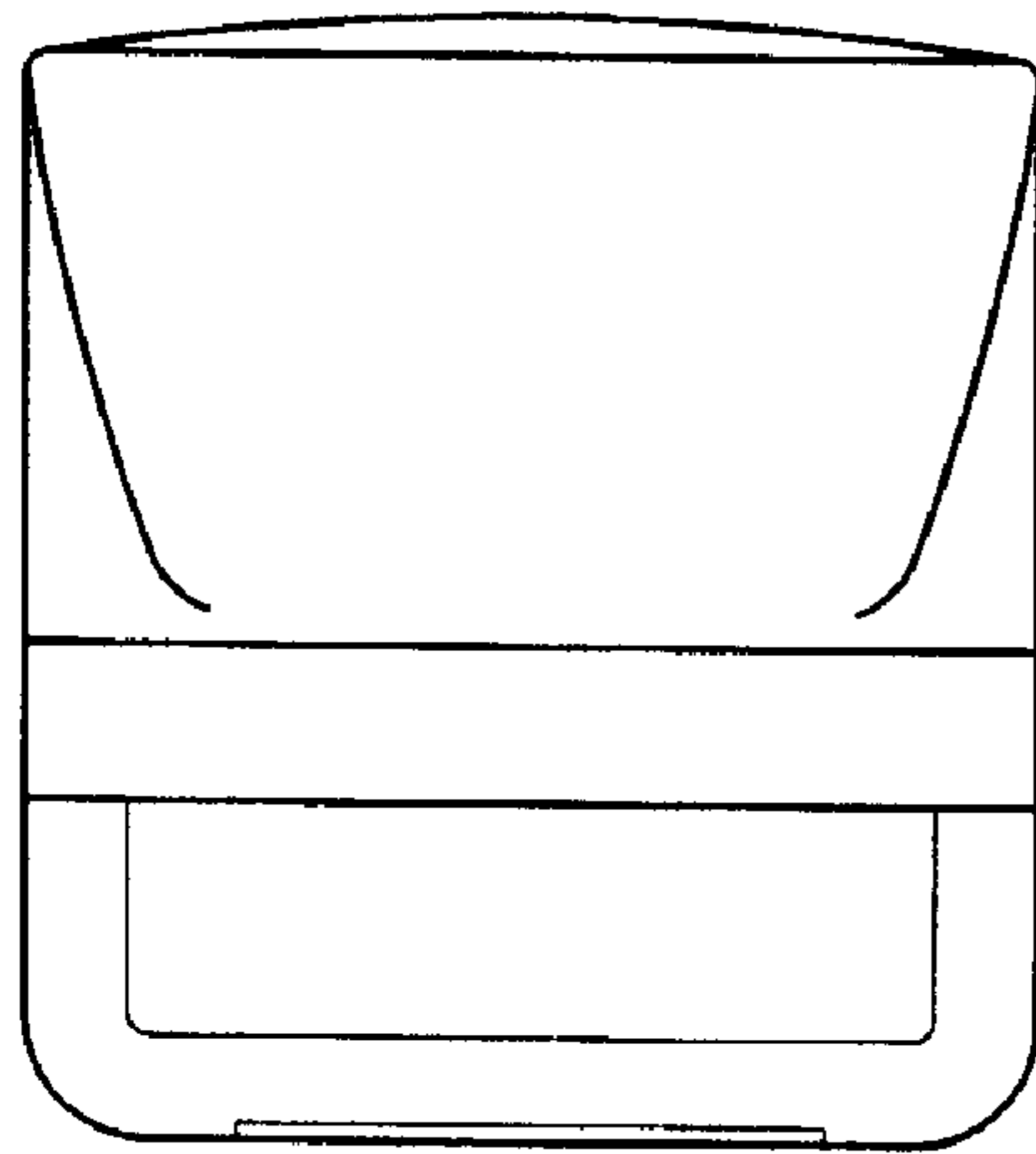

FIG. 6

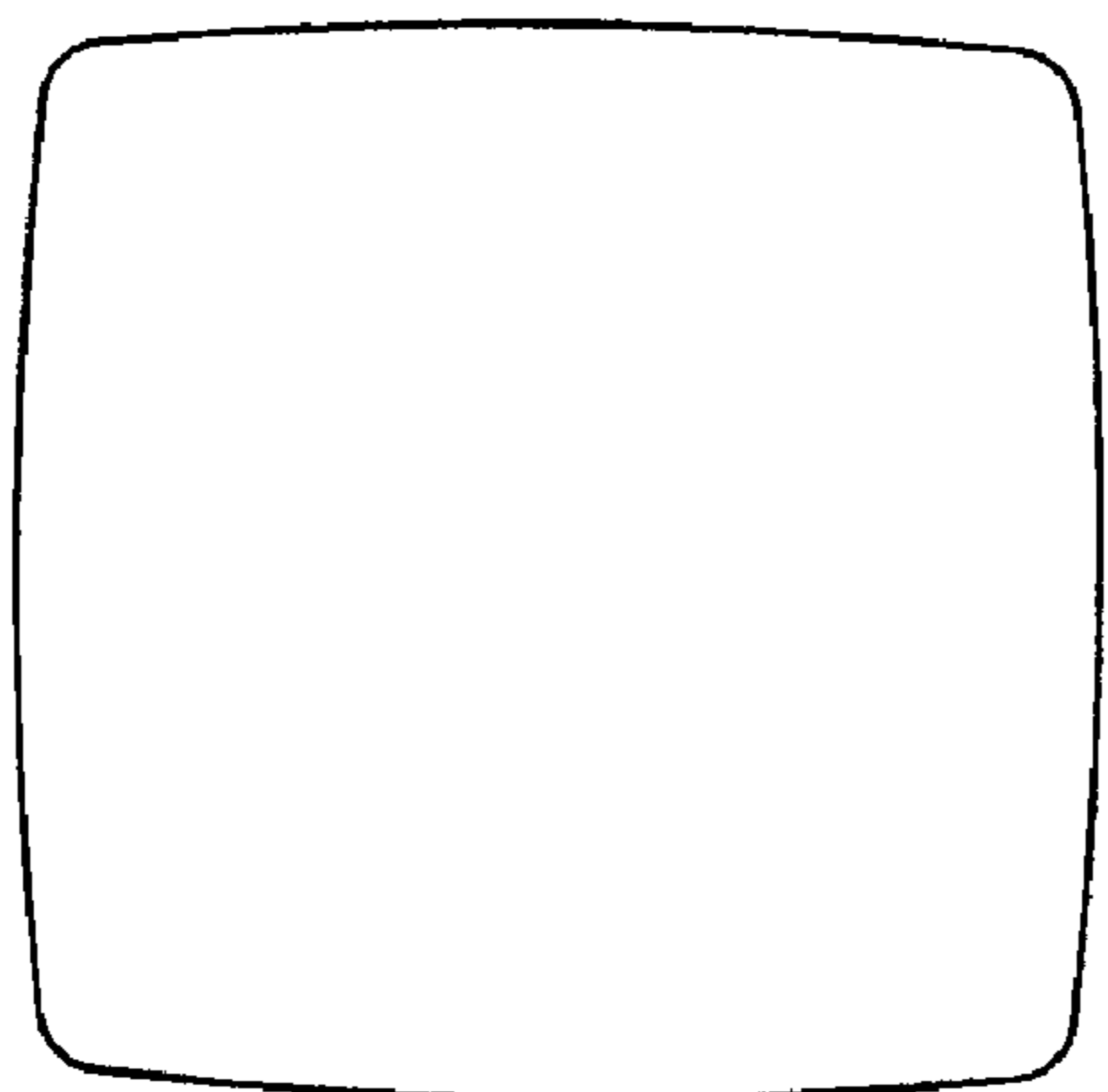

FIG. 7

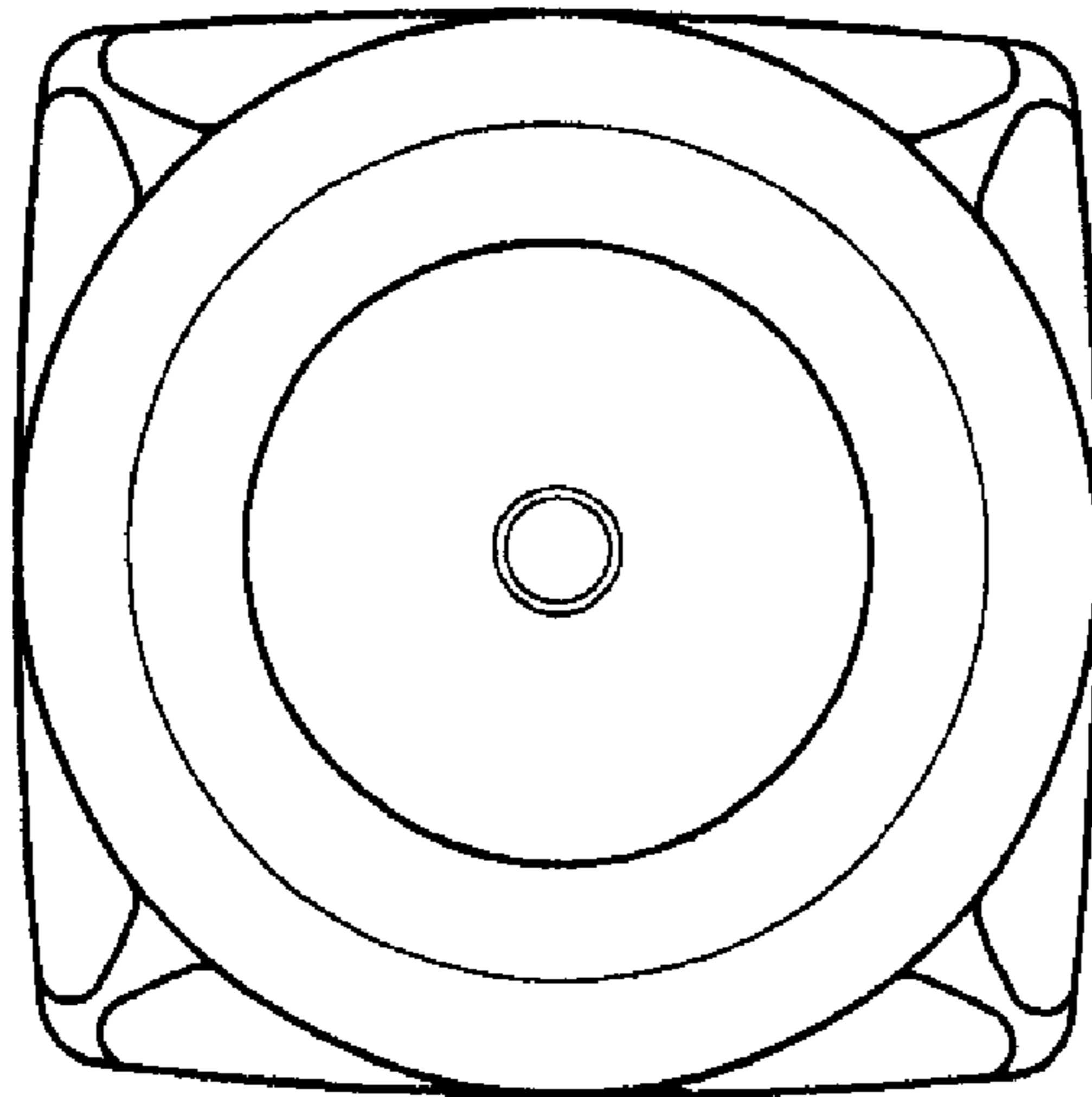

FIG. 8

