



US00D532521S

(12) **United States Design Patent**
Struckmeier

(10) **Patent No.:** **US D532,521 S**

(45) **Date of Patent:** **** Nov. 21, 2006**

(54) **PACIFIER**

(75) Inventor: **Armin Struckmeier**, Pattensen (DE)

(73) Assignee: **Novatex GmbH**, Pattensen (DE)

(**) Term: **14 Years**

(21) Appl. No.: **29/228,677**

(22) Filed: **Apr. 27, 2005**

(30) **Foreign Application Priority Data**

Oct. 27, 2004 (DE) 404 06 174

(51) **LOC (8) Cl.** **24-04**

(52) **U.S. Cl.** **D24/194**

(58) **Field of Classification Search** D24/195,
D24/194, 196; 606/234–236; 206/234; 215/11.1–11.6
See application file for complete search history.

(56) **References Cited**

U.S. PATENT DOCUMENTS

D380,836 S * 7/1997 Fitzpatrick et al. D24/194
D413,387 S * 8/1999 Fitzpatrick et al. D24/194

D414,267 S * 9/1999 Calandro, Jr. D24/194
D418,604 S * 1/2000 Burym et al. D24/194
6,695,869 B1 * 2/2004 Fitzpatrick et al. 606/234
6,905,507 B1 * 6/2005 Hinshaw 606/235
D520,640 S * 5/2006 Pils et al. D24/194

* cited by examiner

Primary Examiner—Ian Simmons

Assistant Examiner—Daniel Yu

(74) *Attorney, Agent, or Firm*—Fay Sharpe Fagan Minnich
& McKee; Karl W. Hauber

(57) **CLAIM**

The ornamental design for a pacifier, as shown and described.

DESCRIPTION

FIG. 1 is a perspective view of the new pacifier;
FIG. 2 is a front plan view thereof;
FIG. 3 is a first side plan view thereof;
FIG. 4 is a top end view thereof;
FIG. 5 is the bottom end view thereof; and,
FIG. 6 is a back end view thereof.

1 Claim, 2 Drawing Sheets

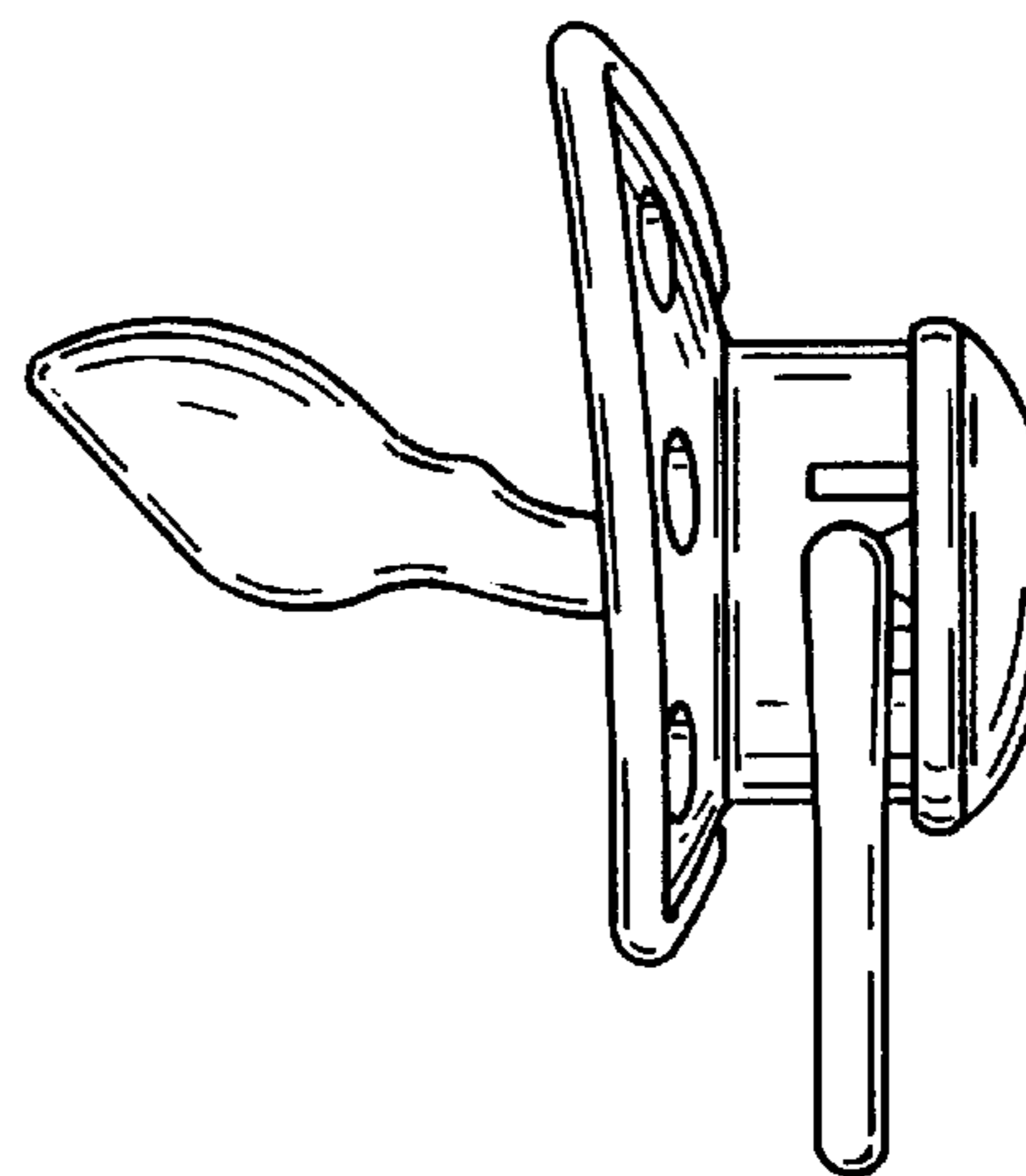
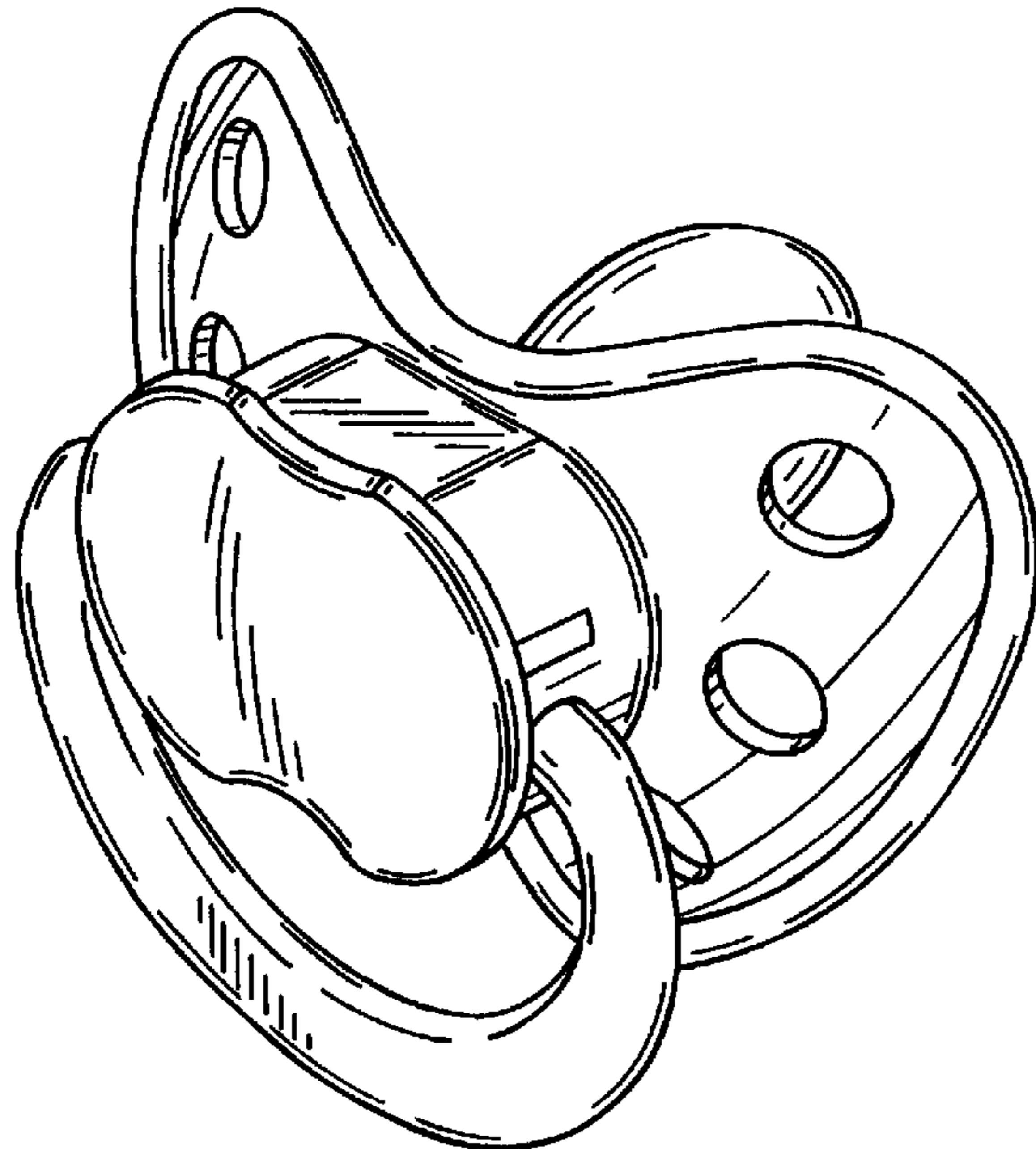

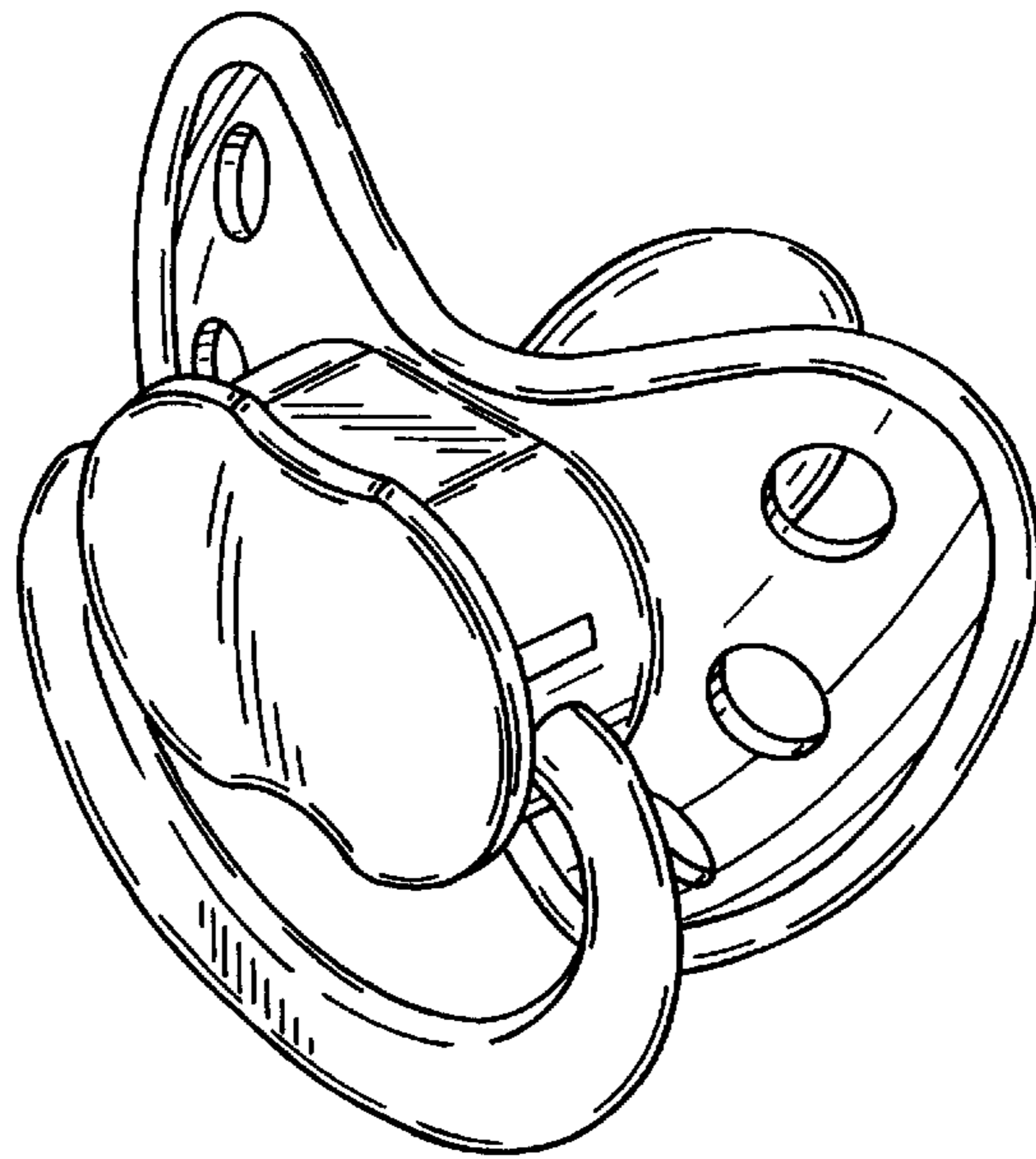

FIG. 1

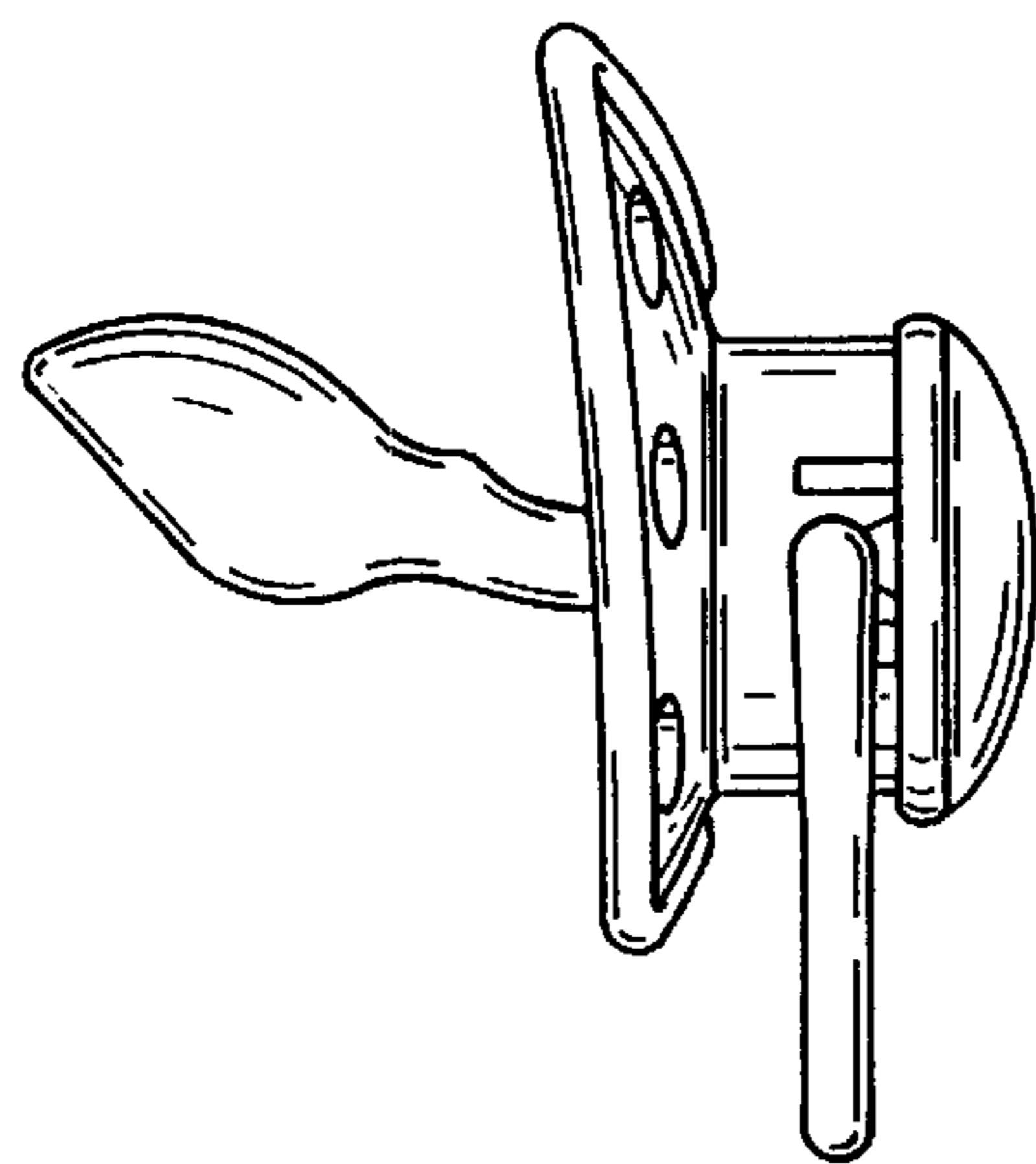

FIG. 3

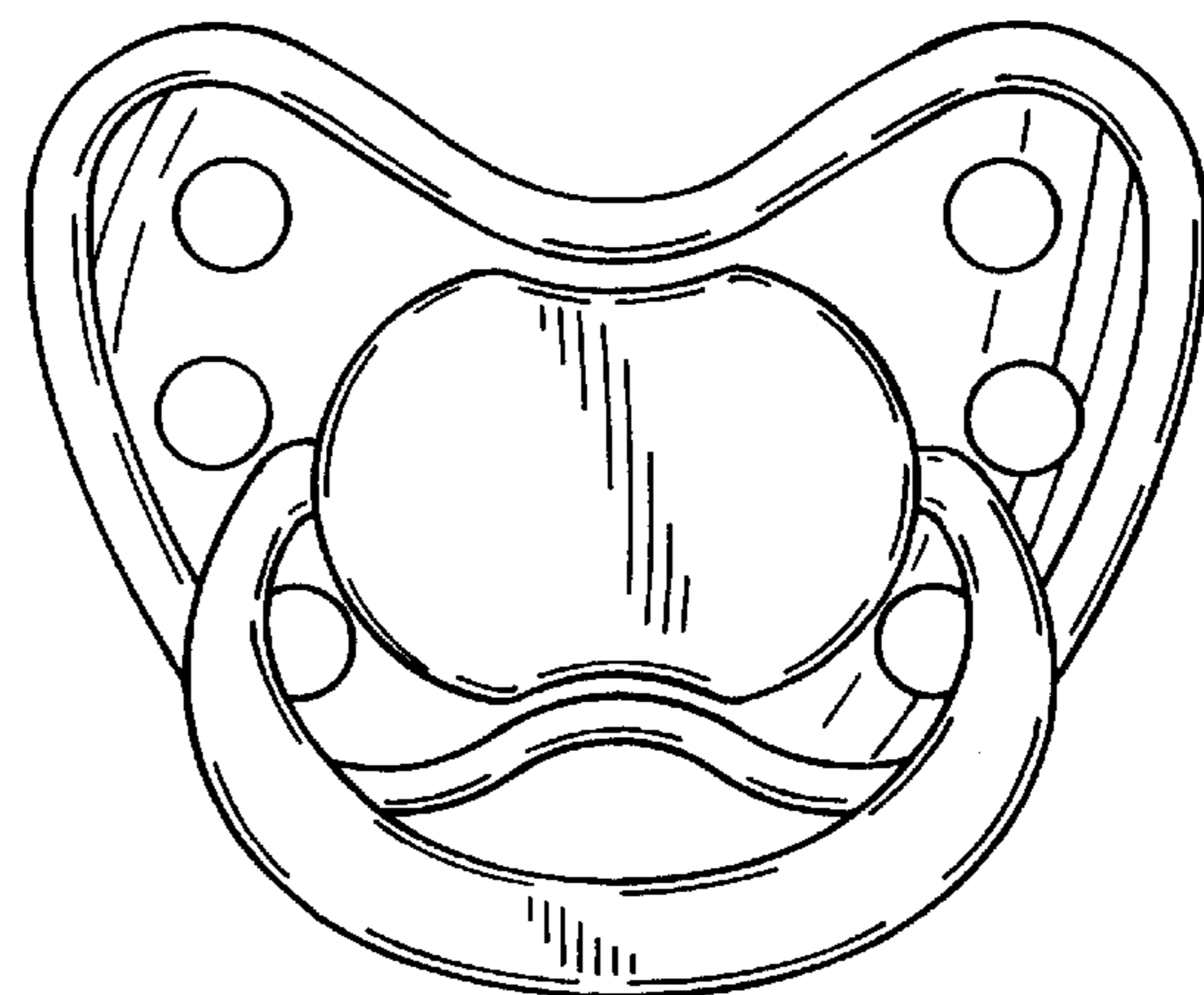

FIG. 2

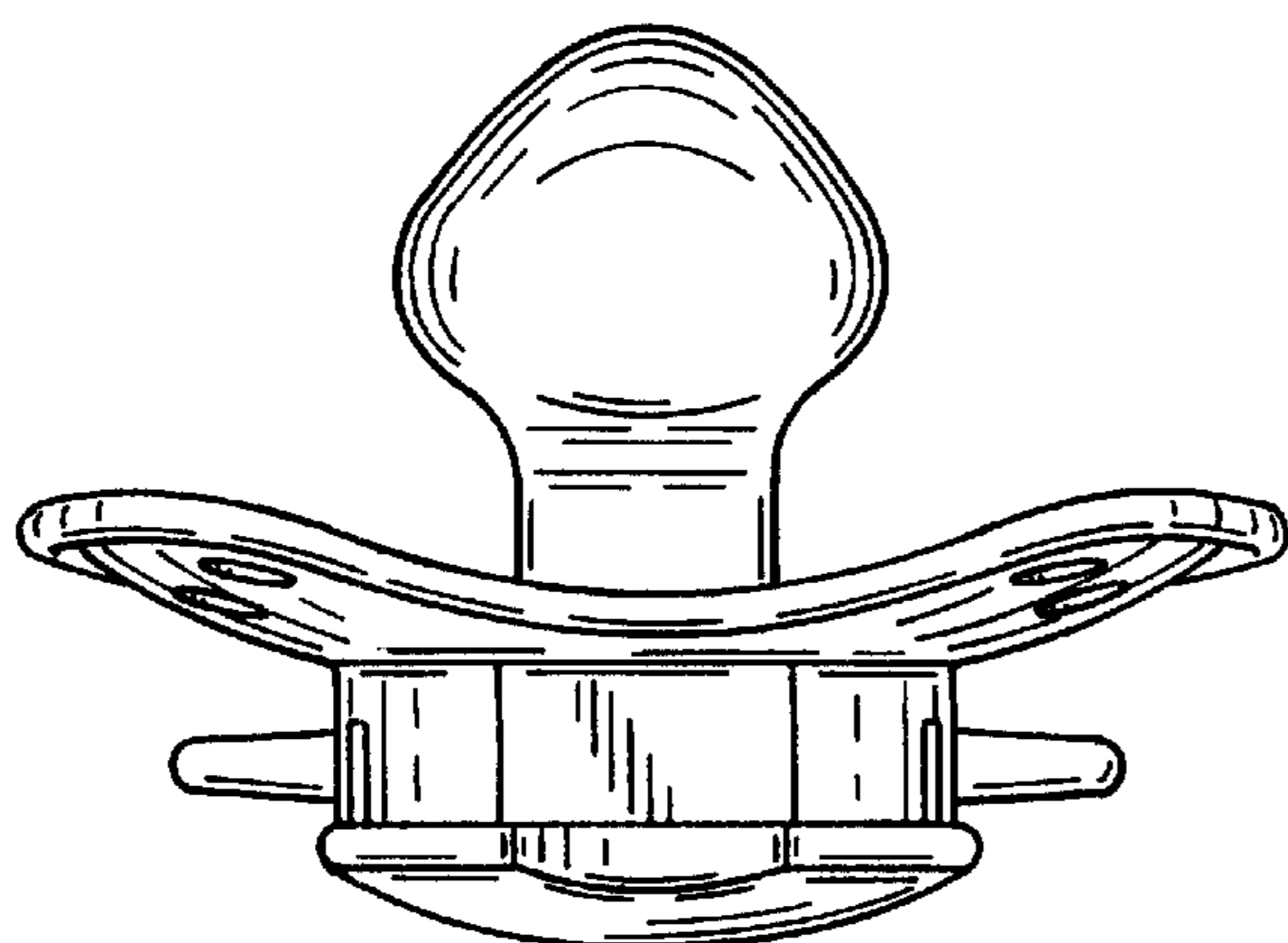

FIG. 4

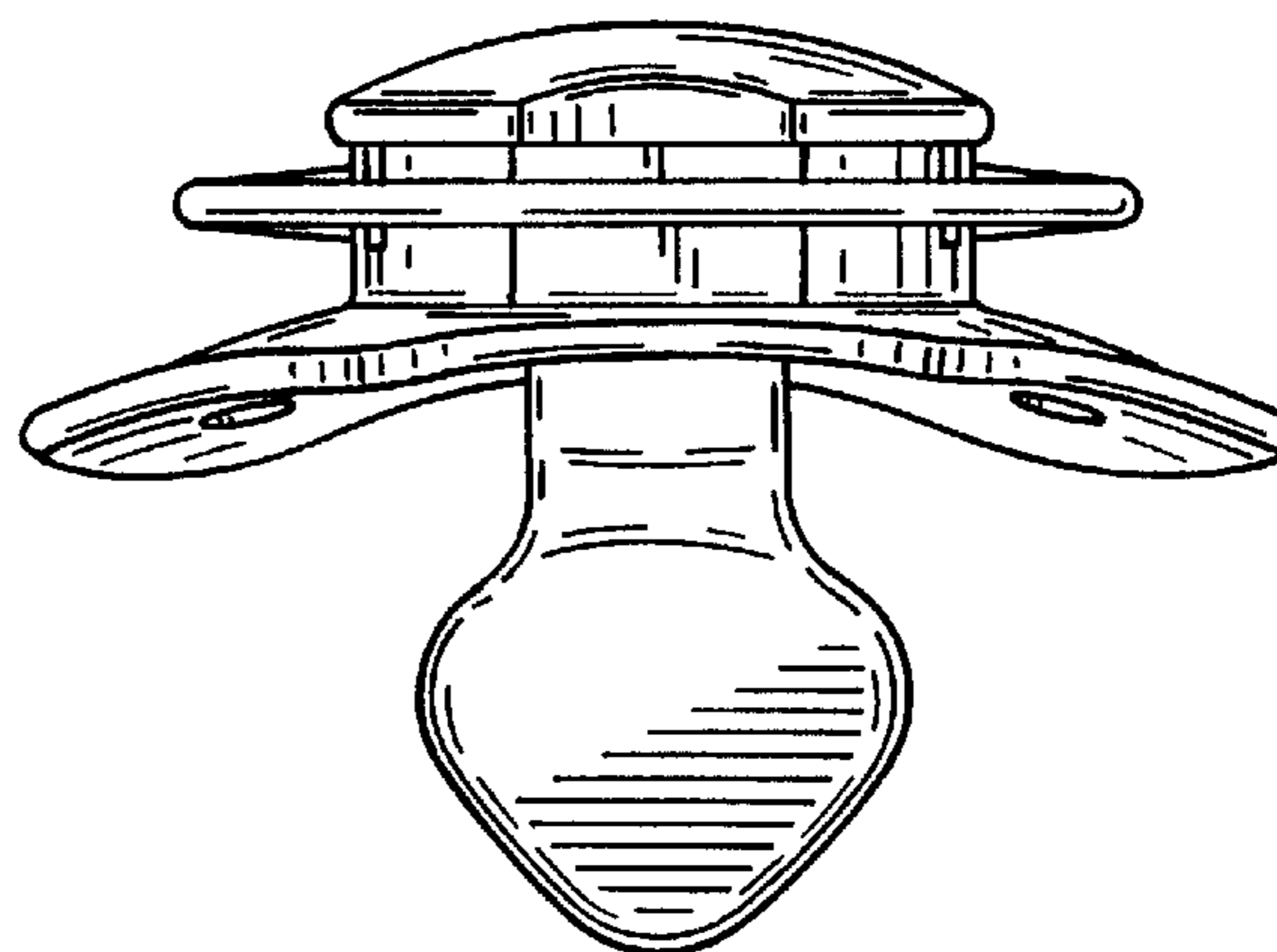

FIG. 5

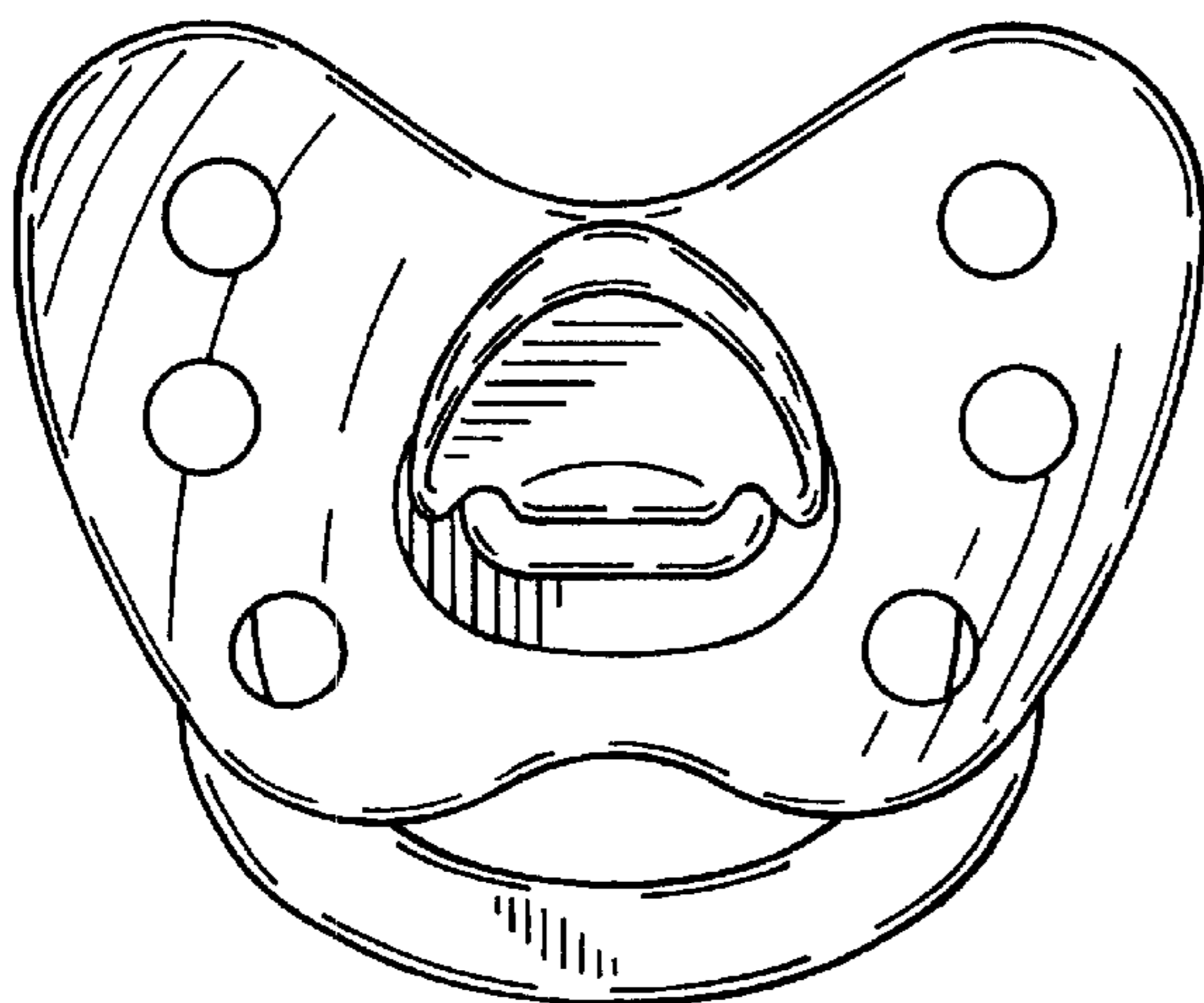

FIG. 6