

US00D532415S

(12) **United States Design Patent**  
**Chen et al.**

(10) **Patent No.:** **US D532,415 S**

(45) **Date of Patent:** **\*\* Nov. 21, 2006**

(54) **KEYBOARD FOR CELL PHONE**  
(75) Inventors: **Chien Shuo Chen**, Taipei County (TW); **Chun Lin Chen**, Taipei County (TW)

D440,566 S \* 4/2001 Chou ..... D14/399  
D442,177 S \* 5/2001 Chang et al. .... D14/392  
D458,929 S \* 6/2002 Kim et al. .... D14/392  
D491,182 S \* 6/2004 Sheehan et al. .... D14/397  
D491,945 S \* 6/2004 Sheehan et al. .... D14/399

(73) Assignee: **Chicony Electronics Co., Ltd.**, Taipei Hsien (TW)

\* cited by examiner

(\*\*) Term: **14 Years**

*Primary Examiner*—Ian Simmons

*Assistant Examiner*—Carla Jobe Wright

(74) *Attorney, Agent, or Firm*—Bacon & Thomas

(21) Appl. No.: **29/240,548**

(57) **CLAIM**

(22) Filed: **Oct. 17, 2005**

We claim the ornamental design for a keyboard for cell phone, as shown and described.

(30) **Foreign Application Priority Data**

**DESCRIPTION**

Aug. 25, 2005 (TW) ..... 94305118

(51) **LOC (8) Cl.** ..... **14-03**

(52) **U.S. Cl.** ..... **D14/247; D14/399**

(58) **Field of Classification Search** ..... D14/138, D14/247, 248, 341, 345, 346, 391, 392, 393, D14/394, 395, 397, 399; 345/169; 379/433.07  
See application file for complete search history.

FIG. 1 is a front perspective view of a keyboard for cell phone showing our new design.

FIG. 2 is a rear perspective view of a keyboard for cell phone showing our new design.

FIG. 3 is a front view thereof;

FIG. 4 is a rear view thereof;

FIG. 5 is a left side view thereof;

FIG. 6 is a right side view thereof;

FIG. 7 is a top plan view thereof; and,

FIG. 8 is a bottom plan view thereof.

(56) **References Cited**

**U.S. PATENT DOCUMENTS**

D347,835 S \* 6/1994 Zarnowitz ..... D14/399

D412,895 S \* 8/1999 Wu ..... D14/392

**1 Claim, 6 Drawing Sheets**

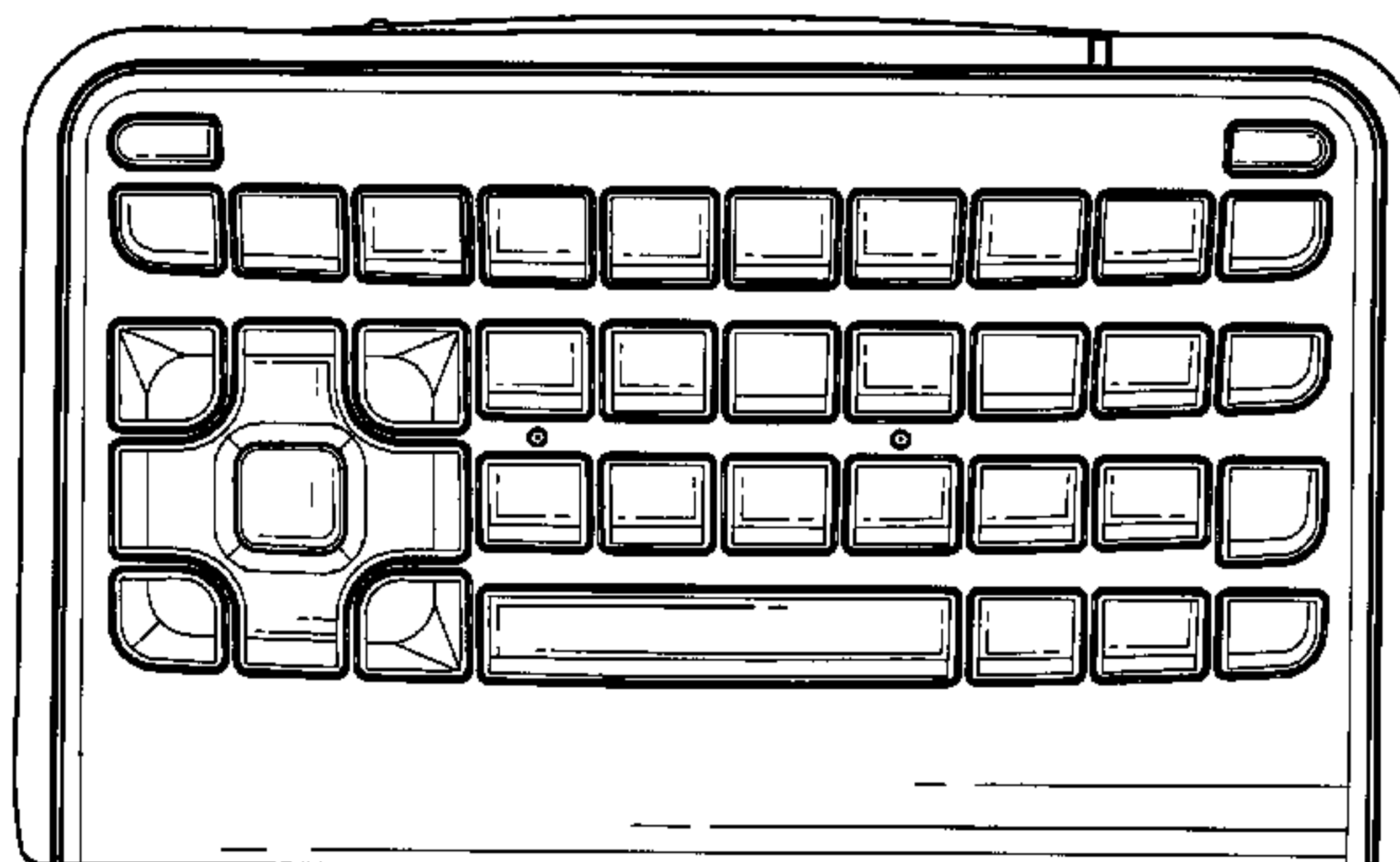
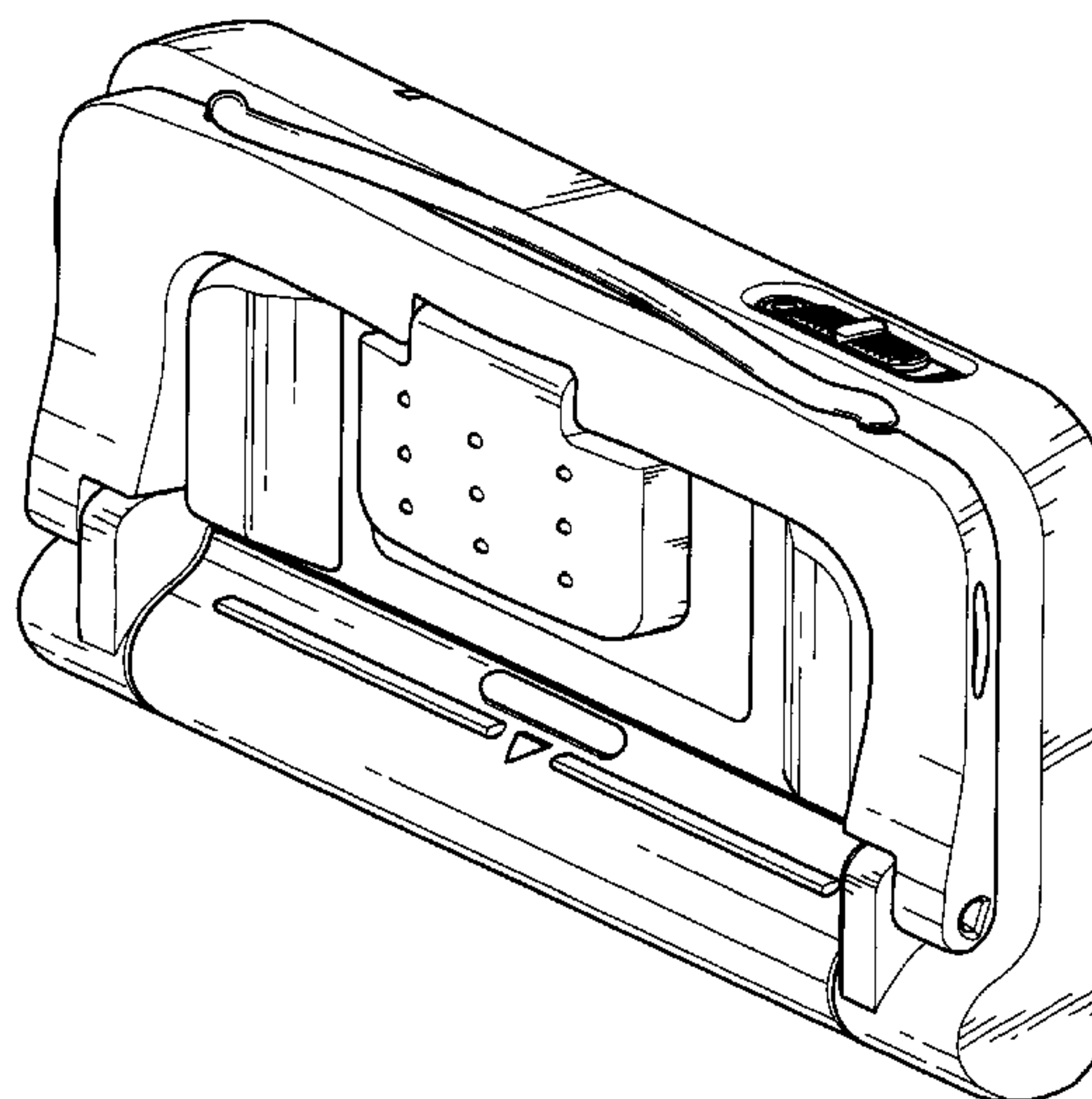

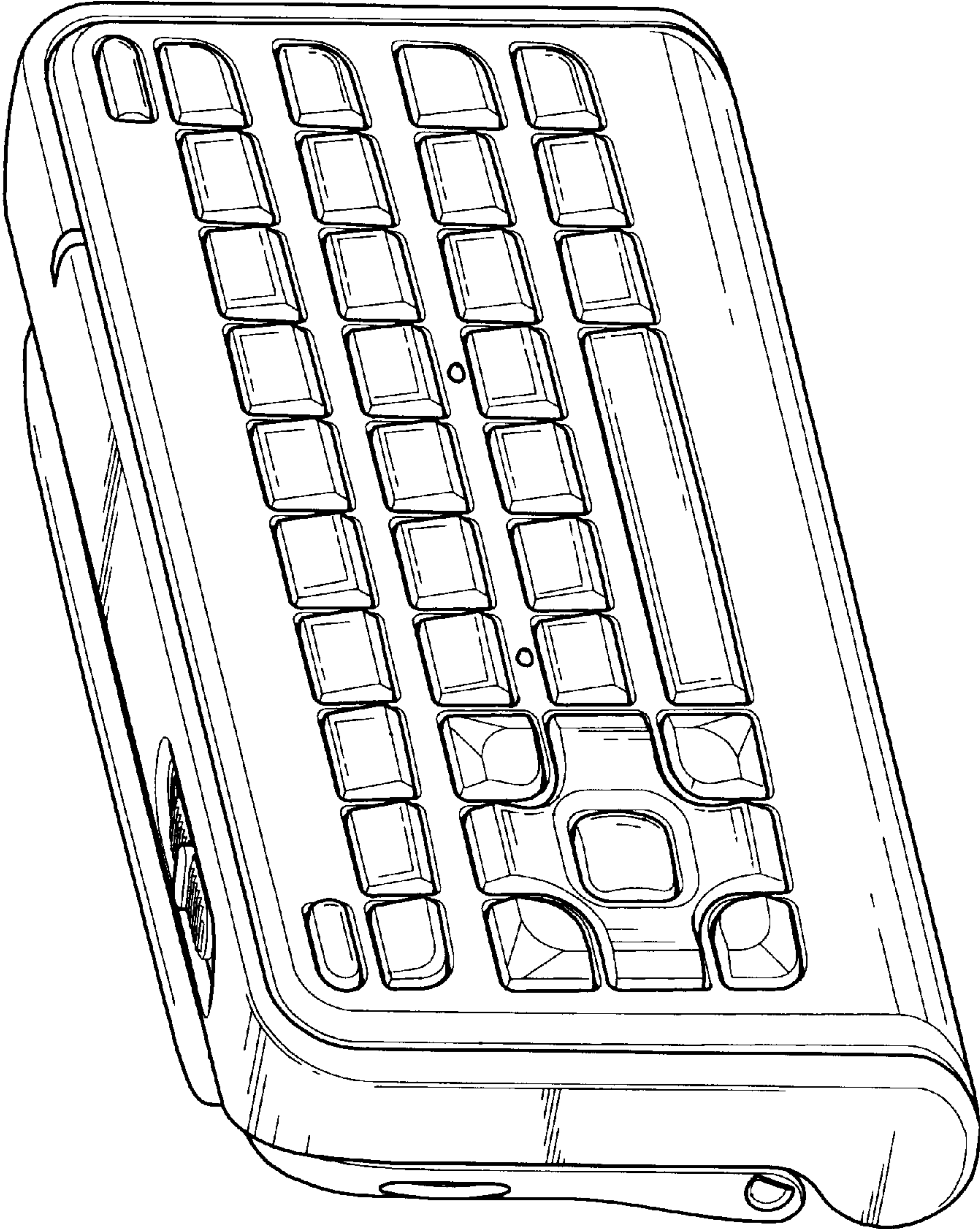

FIG.1



FIG.2

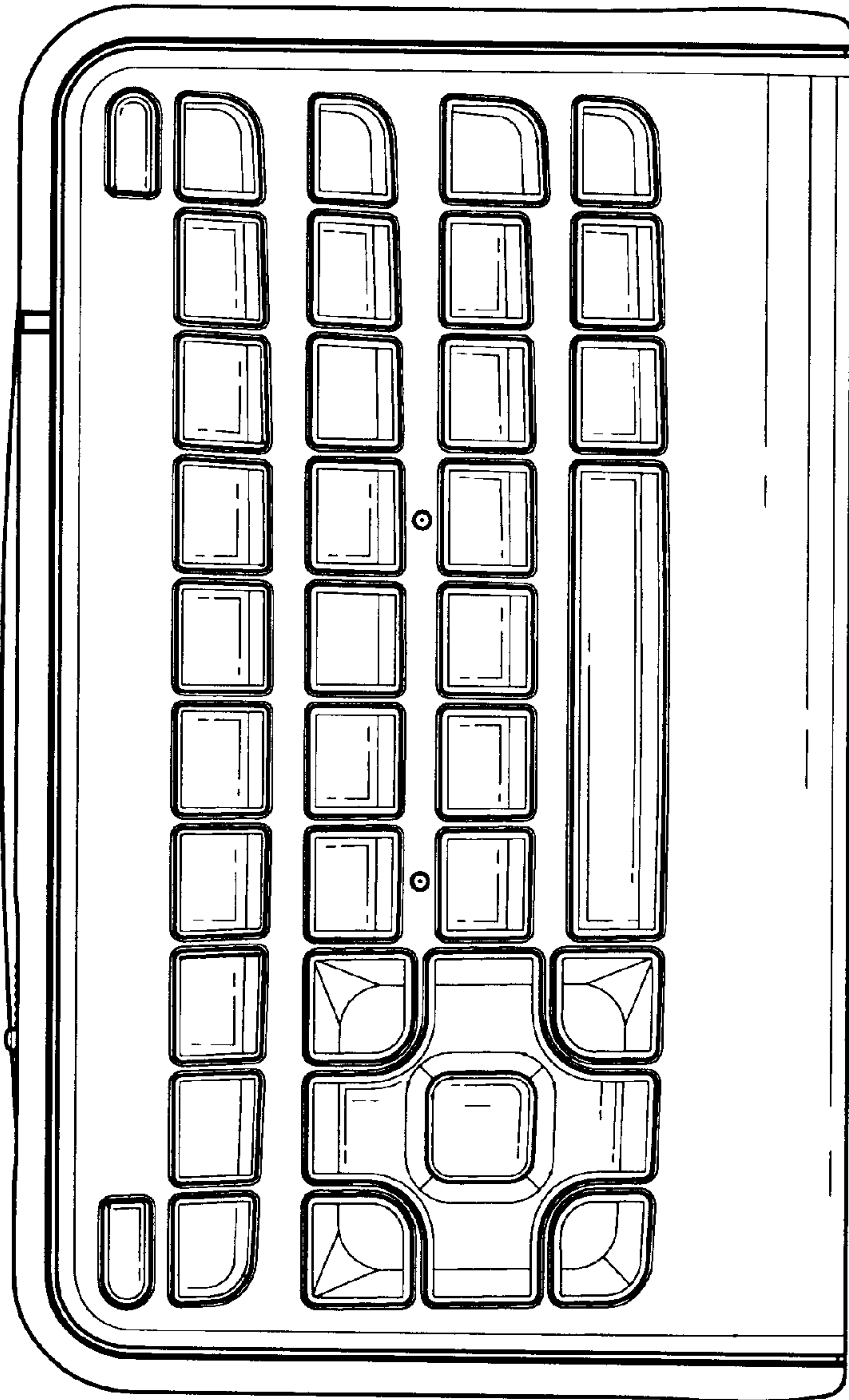

FIG. 3

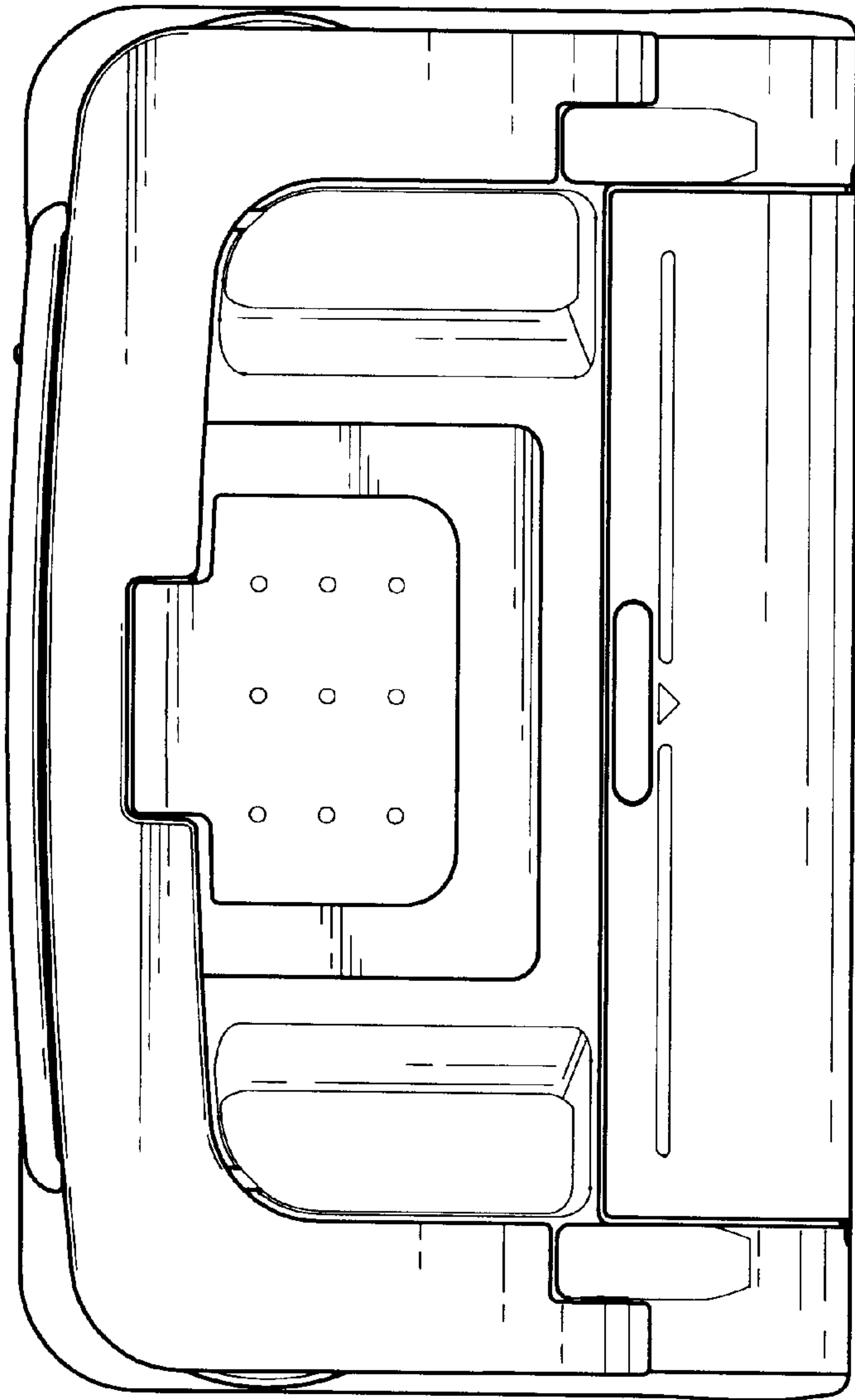

FIG.4



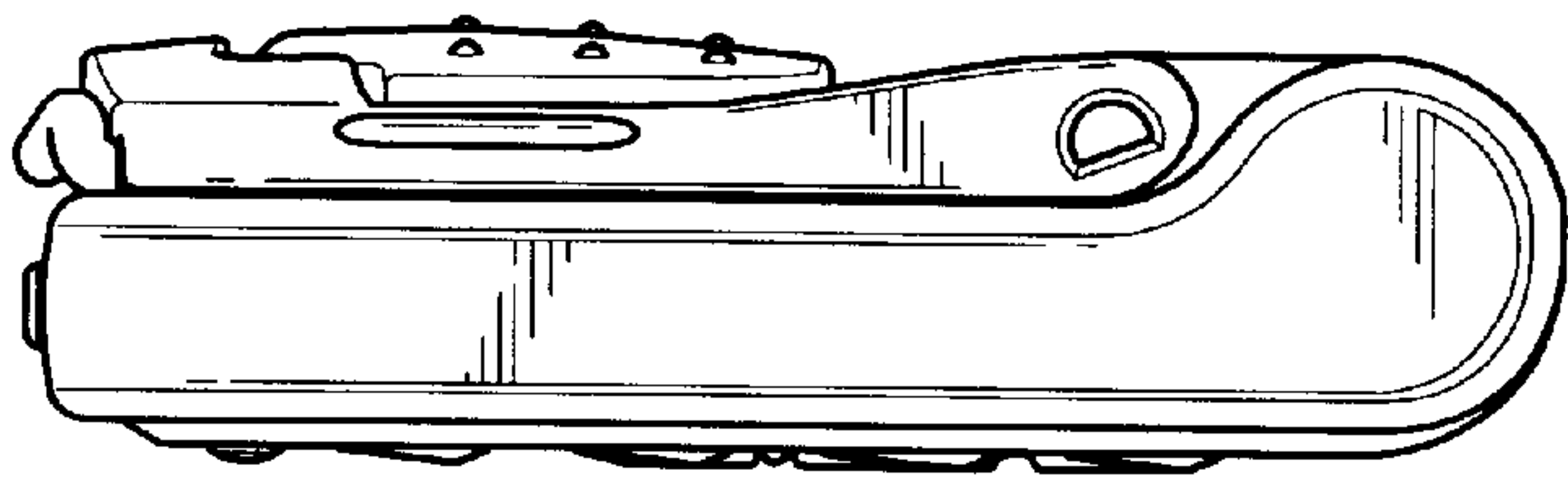

FIG.6

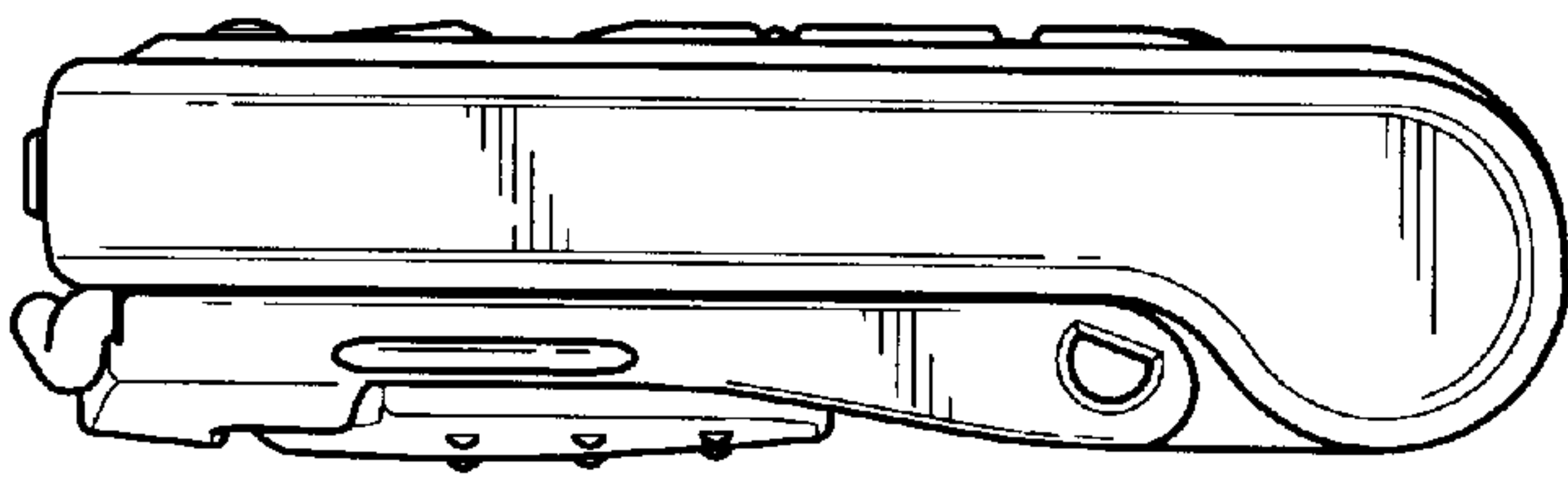

FIG.5



FIG. 7



FIG. 8