



US00D532039S

(12) **United States Design Patent** (10) **Patent No.:** **US D532,039 S**  
**Beck et al.** (45) **Date of Patent:** **\*\* Nov. 14, 2006**

(54) **PORTABLE ELECTRONIC DEVICE**

2006/0008312 A1 \* 1/2006 Sago et al. .... 400/642

(75) Inventors: **David Beck**, Exeter, RI (US); **Richard James Preliasco**, North Kingstown, RI (US); **Mark Steiner**, Greenwich, CT (US)

FOREIGN PATENT DOCUMENTS

GB 2093758 \* 8/2000

\* cited by examiner

(73) Assignee: **ZIH Corp.**, Hamilton (BM)

*Primary Examiner*—Charles A. Rademaker

(74) *Attorney, Agent, or Firm*—Alston & Bird LLP

(\*\*) Term: **14 Years**

(57) **CLAIM**

(21) Appl. No.: **29/210,268**

The ornamental design for a portable electronic device, as shown and described.

(22) Filed: **Jul. 29, 2004**

**DESCRIPTION**

(51) **LOC (8) Cl.** ..... **18-02**

(52) **U.S. Cl.** ..... **D18/50; D13/184**

(58) **Field of Classification Search** ..... D18/50, D18/54, 54.1, 56–59, 35.1; 347/171, 108, 347/170, 220, 263; 400/625, 642, 680, 120.6, 400/692, 613.1; D6/635, 499; D10/75–77, D10/81; D16/221–234; D14/474, 168, 469; D8/400, 366, 384, 499; D13/182, 184

See application file for complete search history.

FIG. 1 is a perspective view of a portable electronic device showing our new design;

FIG. 2 is a top plan view thereof;

FIG. 3 is a front elevation thereof;

FIG. 4 is a right side elevation thereof;

FIG. 5 is a left side elevation thereof;

FIG. 6 is a rear elevation thereof;

FIG. 7 is a bottom plan view thereof

FIG. 8 is a perspective view of a modified embodiment of the design shown in FIGS. 1 through 7;

FIG. 9 is a top plan view thereof;

FIG. 10 is a front elevation thereof;

FIG. 11 is a right side elevation thereof;

FIG. 12 is a left side elevation thereof;

FIG. 13 is a rear elevation thereof;

FIG. 14 is a bottom plan view thereof;

FIG. 15 is a perspective view of a perspective view of a second modified embodiment of the design shown in FIGS. 1 through 7;

FIG. 16 is a top plan view thereof;

FIG. 17 is a front elevation thereof;

FIG. 18 is a right side elevation thereof;

FIG. 19 is a left side elevation thereof;

FIG. 20 is a rear elevation thereof; and,

FIG. 21 is a bottom plan view thereof.

The broken lines shown herein are for illustrative purposes only and form no part of the claimed design.

(56) **References Cited**

U.S. PATENT DOCUMENTS

D286,654	S	*	11/1986	Picard	.....	D18/50
D320,226	S	*	9/1991	Hermann et al.	.....	D18/50
5,180,905	A		1/1993	Chen et al.		
D359,485	S	*	6/1995	Park	.....	D14/469
D370,471	S	*	6/1996	Au	.....	D18/50
D388,785	S	*	1/1998	Yuen	.....	D14/168
D424,100	S	*	5/2000	Hesselbach	.....	D18/50
6,065,679	A		5/2000	Levie et al.		
D443,890	S	*	6/2001	Sato et al.	.....	D18/50
6,262,754	B1	*	7/2001	Watanabe et al.	.....	347/171
6,364,550	B1		4/2002	Petteruti		
6,409,401	B1		6/2002	Petteruti et al.		
6,540,122	B1		4/2003	Peterson		
6,607,316	B1		8/2003	Petteruti et al.		
6,609,844	B1		8/2003	Petteruti et al.		
D501,025	S	*	1/2005	Sugrue et al.	.....	D18/35.1
D505,447	S	*	5/2005	Wong et al.	.....	D18/50
D514,075	S	*	1/2006	Hahn et al.	.....	D13/184

**1 Claim, 21 Drawing Sheets**

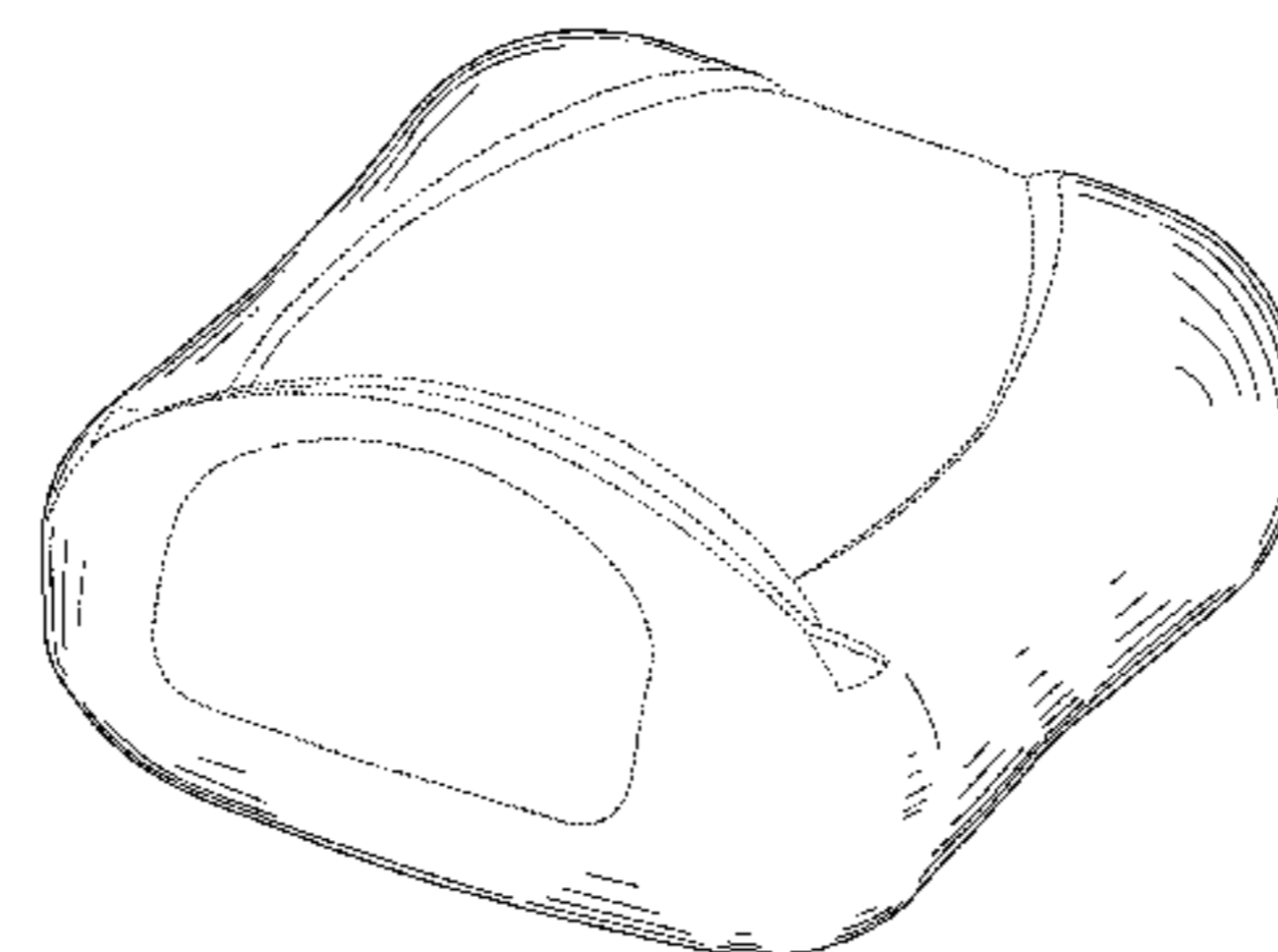
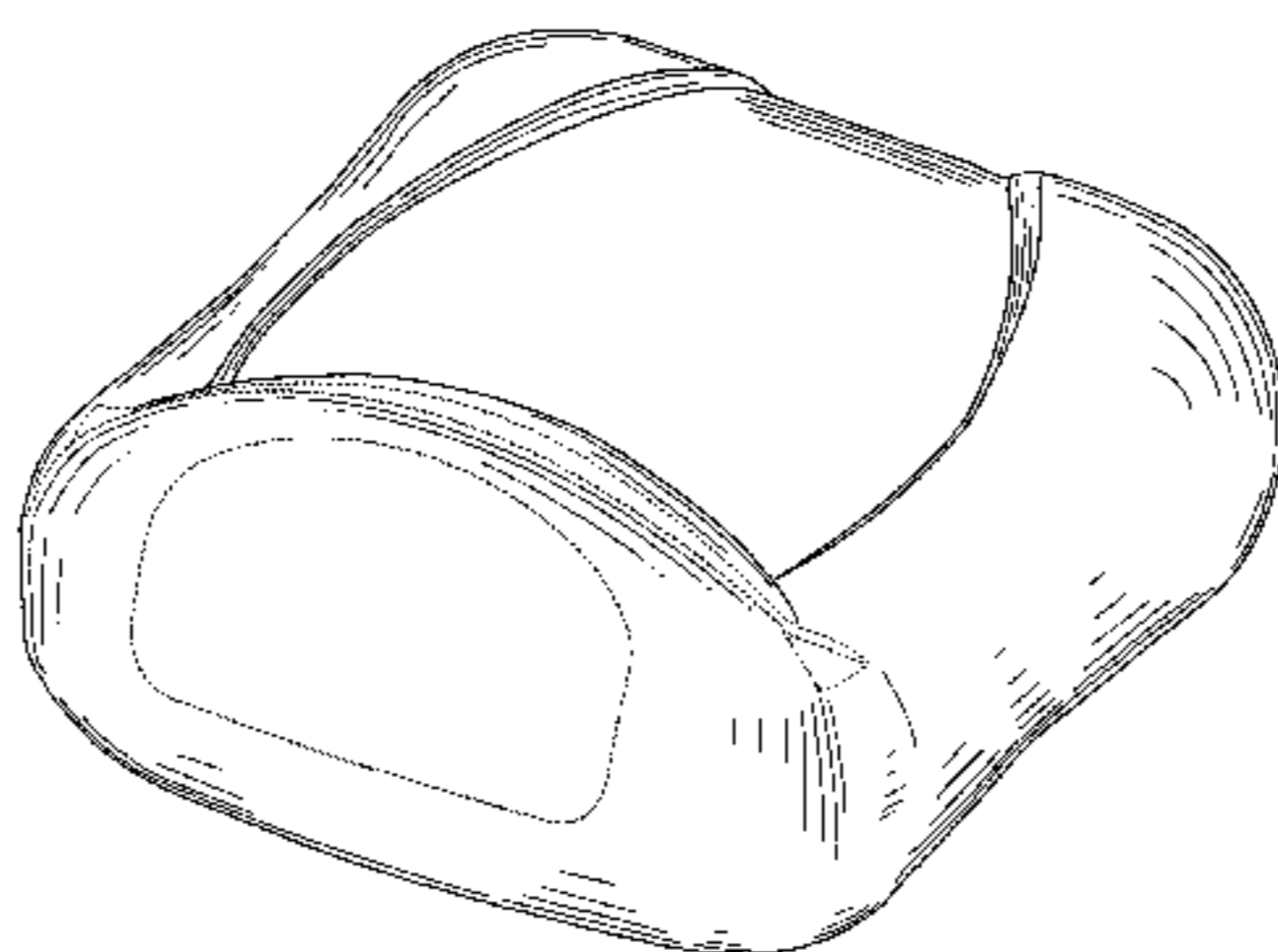
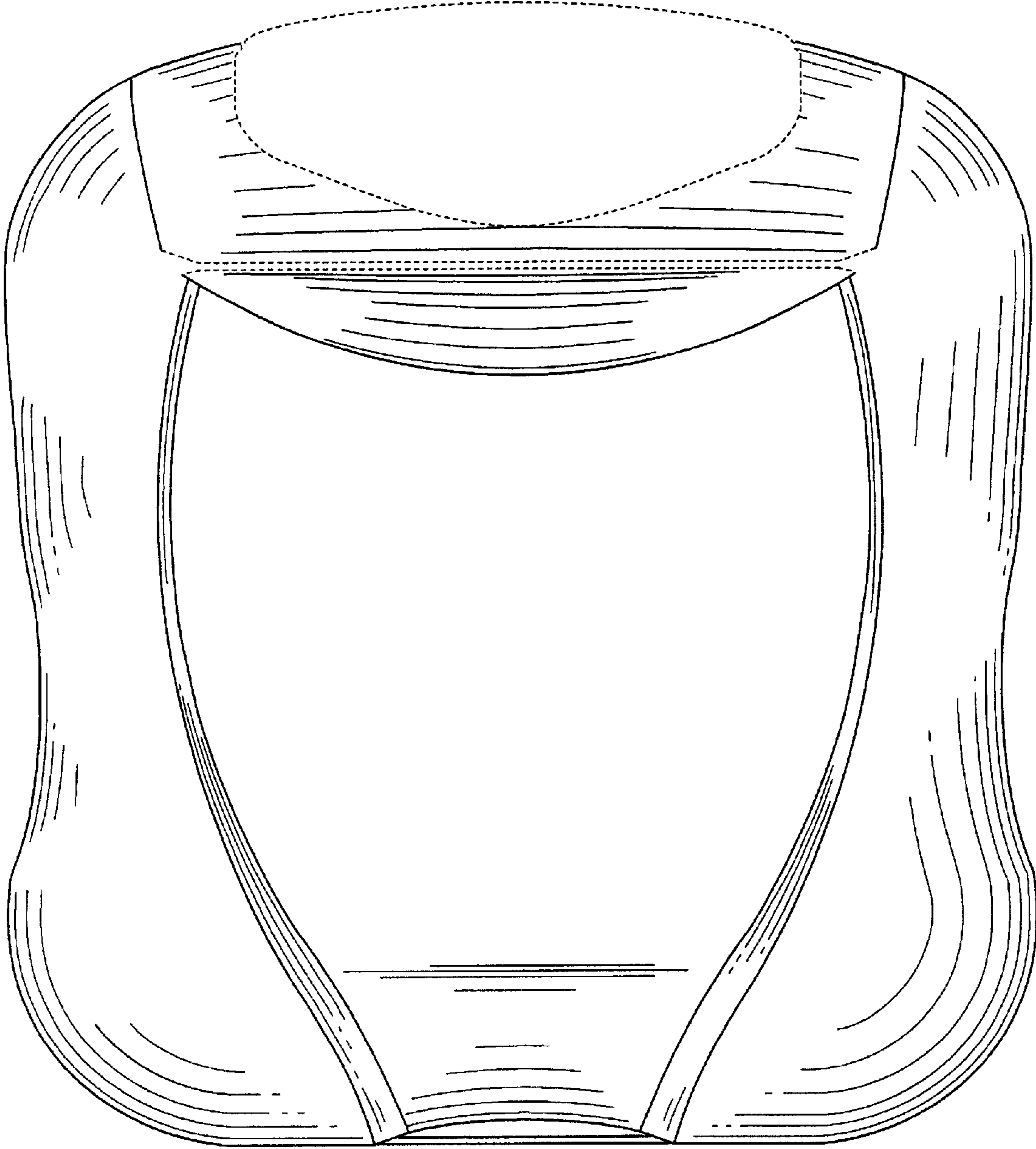
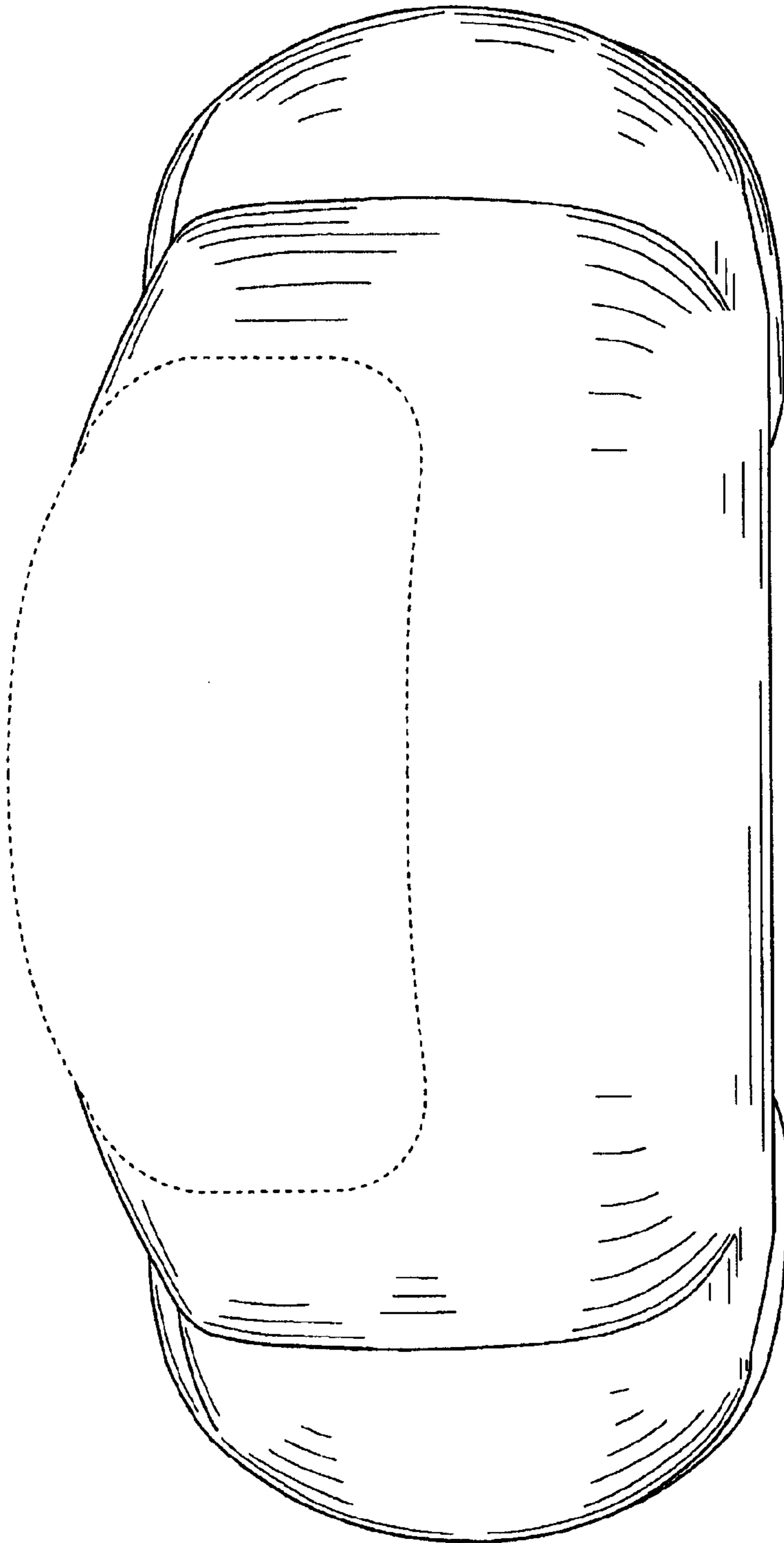




FIG. 1

FIG. 2





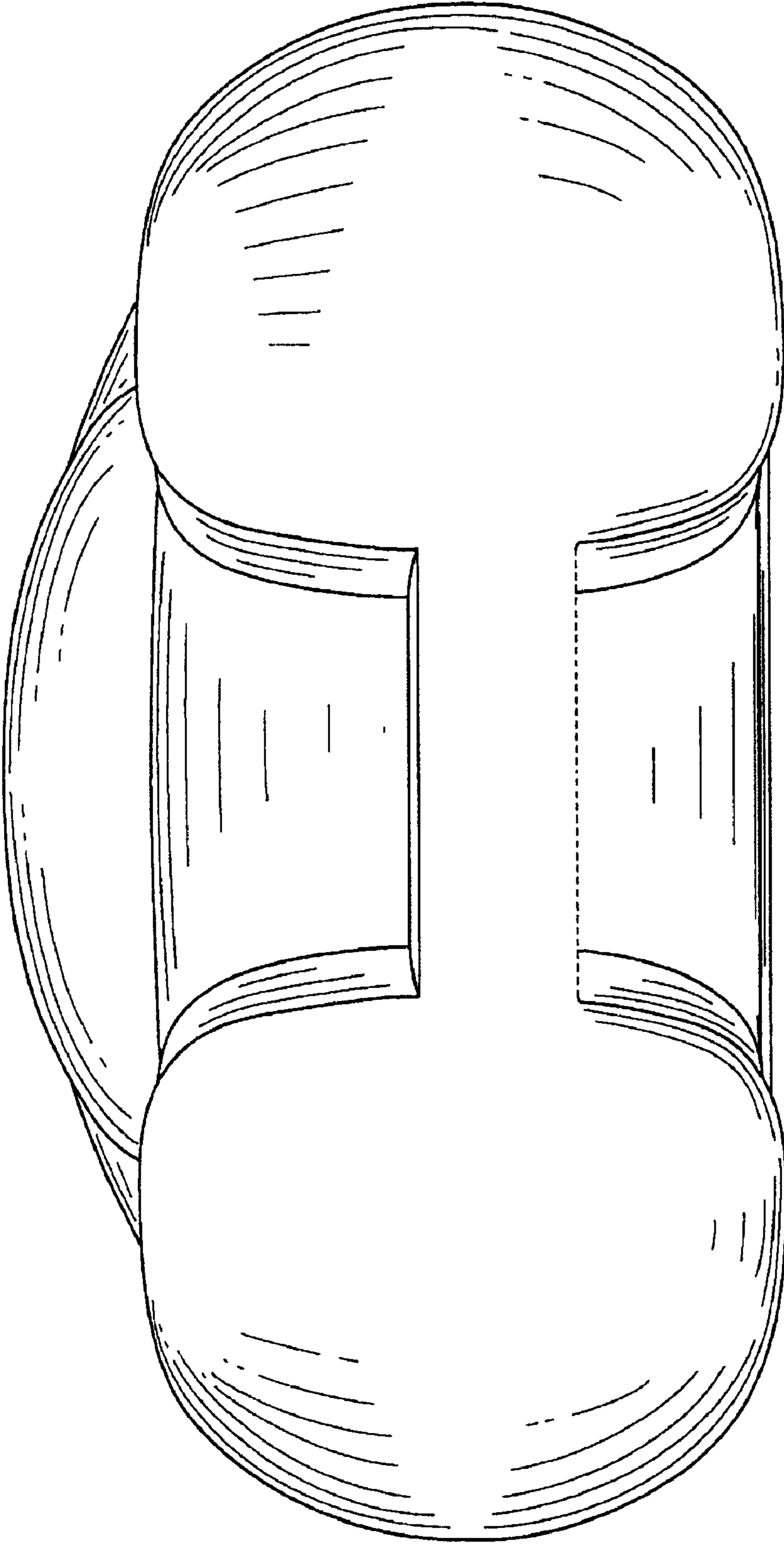
**FIG. 3**



**FIG. 4**

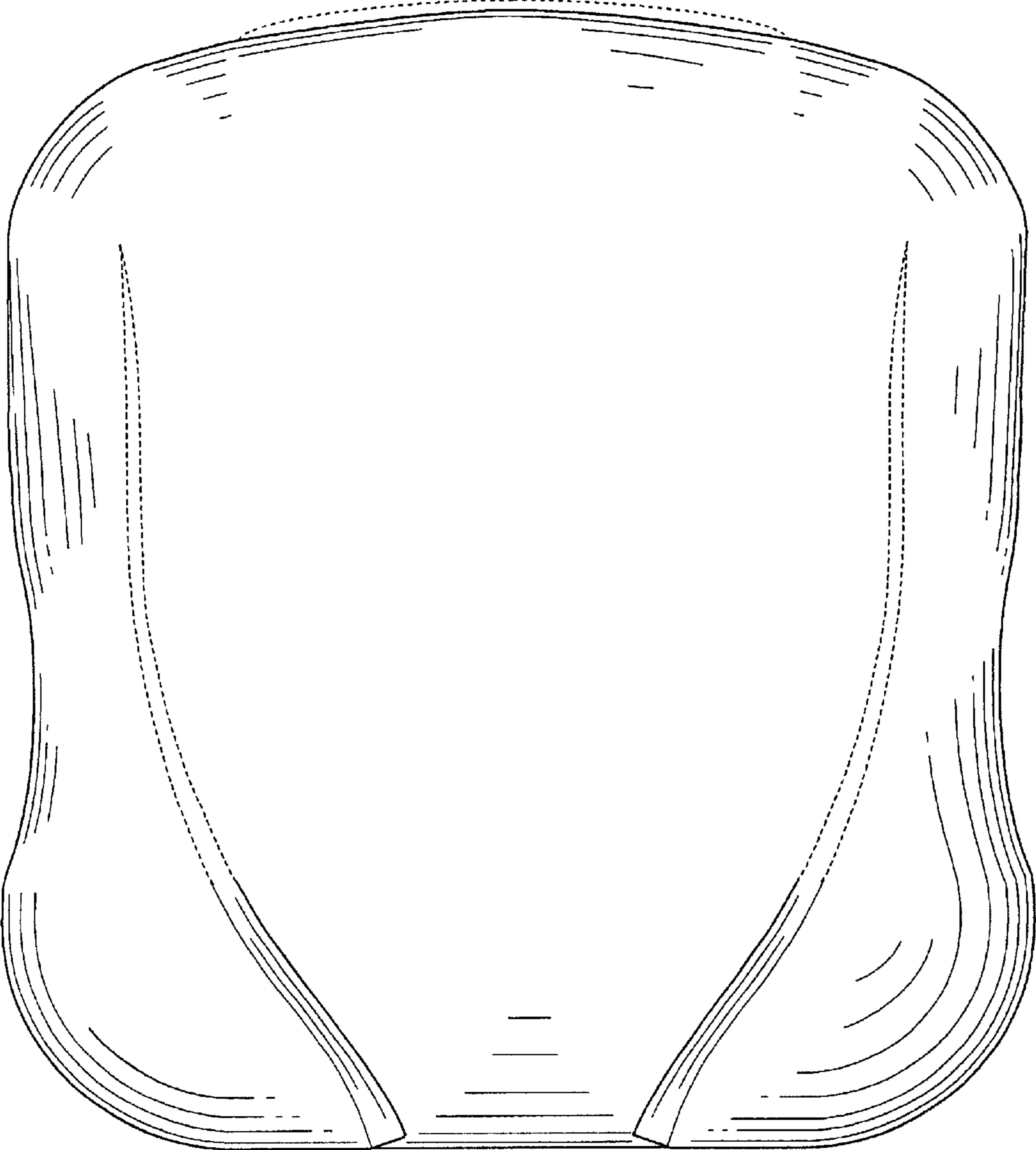


**FIG. 5**

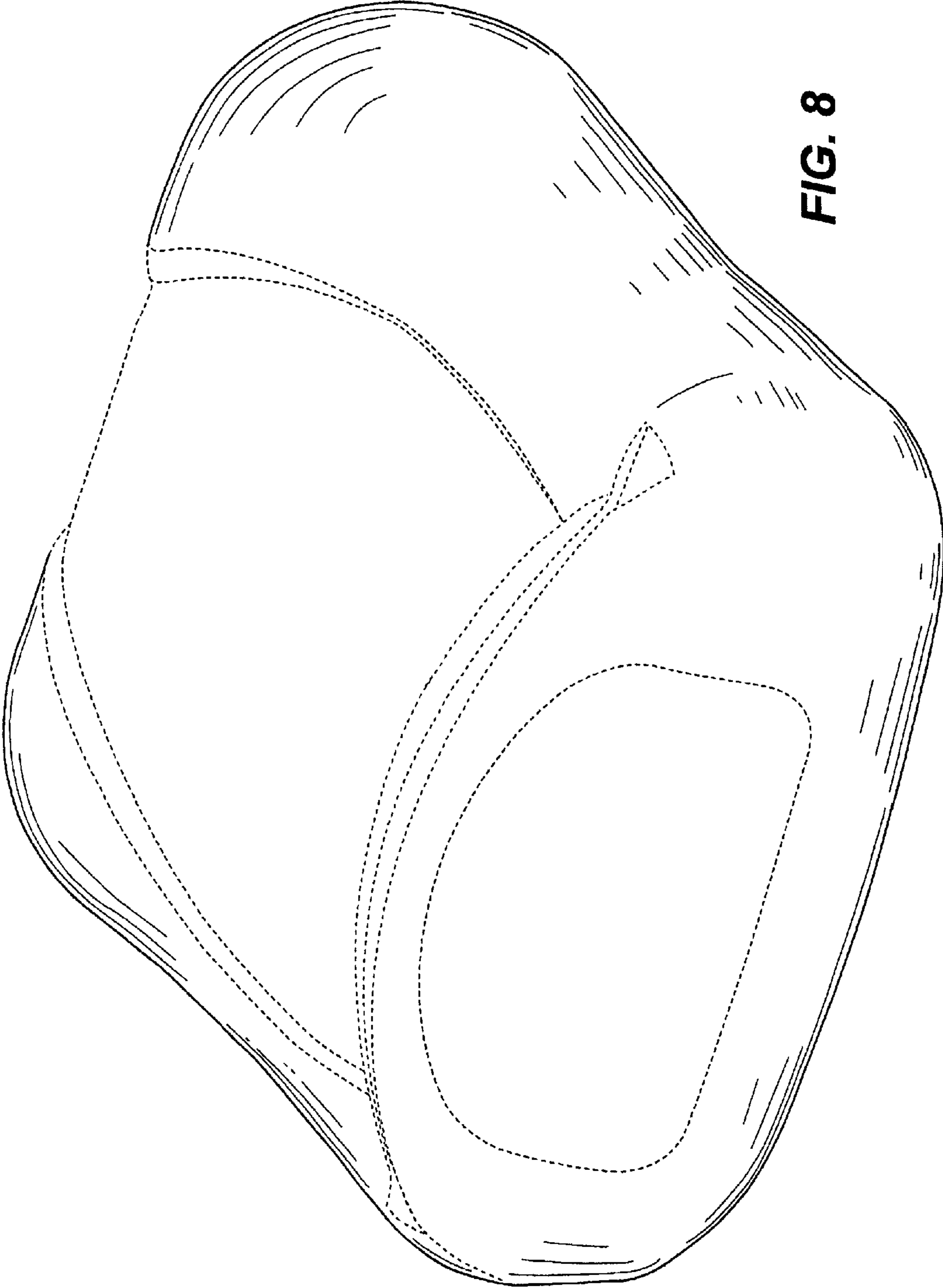


**FIG. 6**

**FIG. 7**

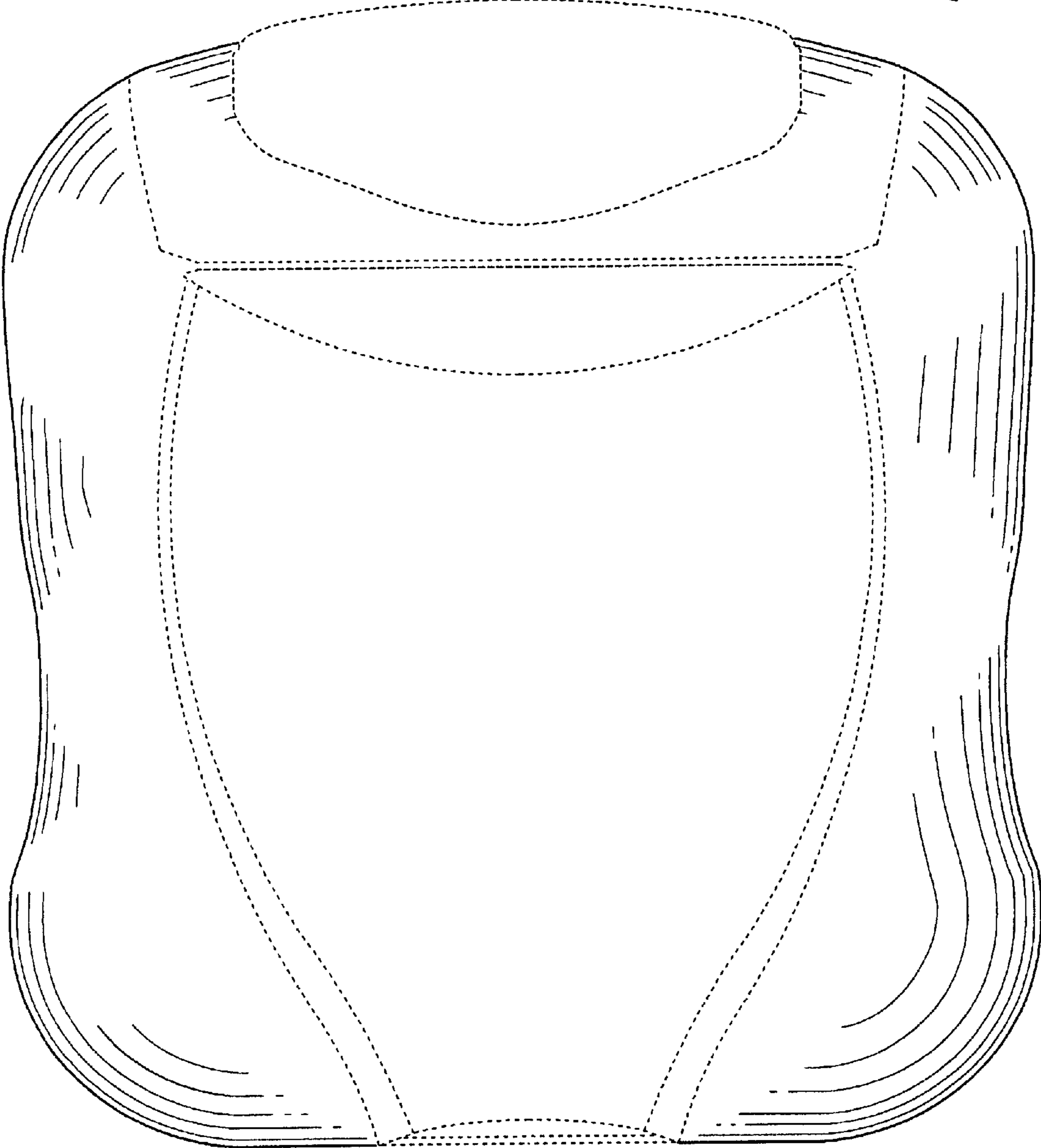


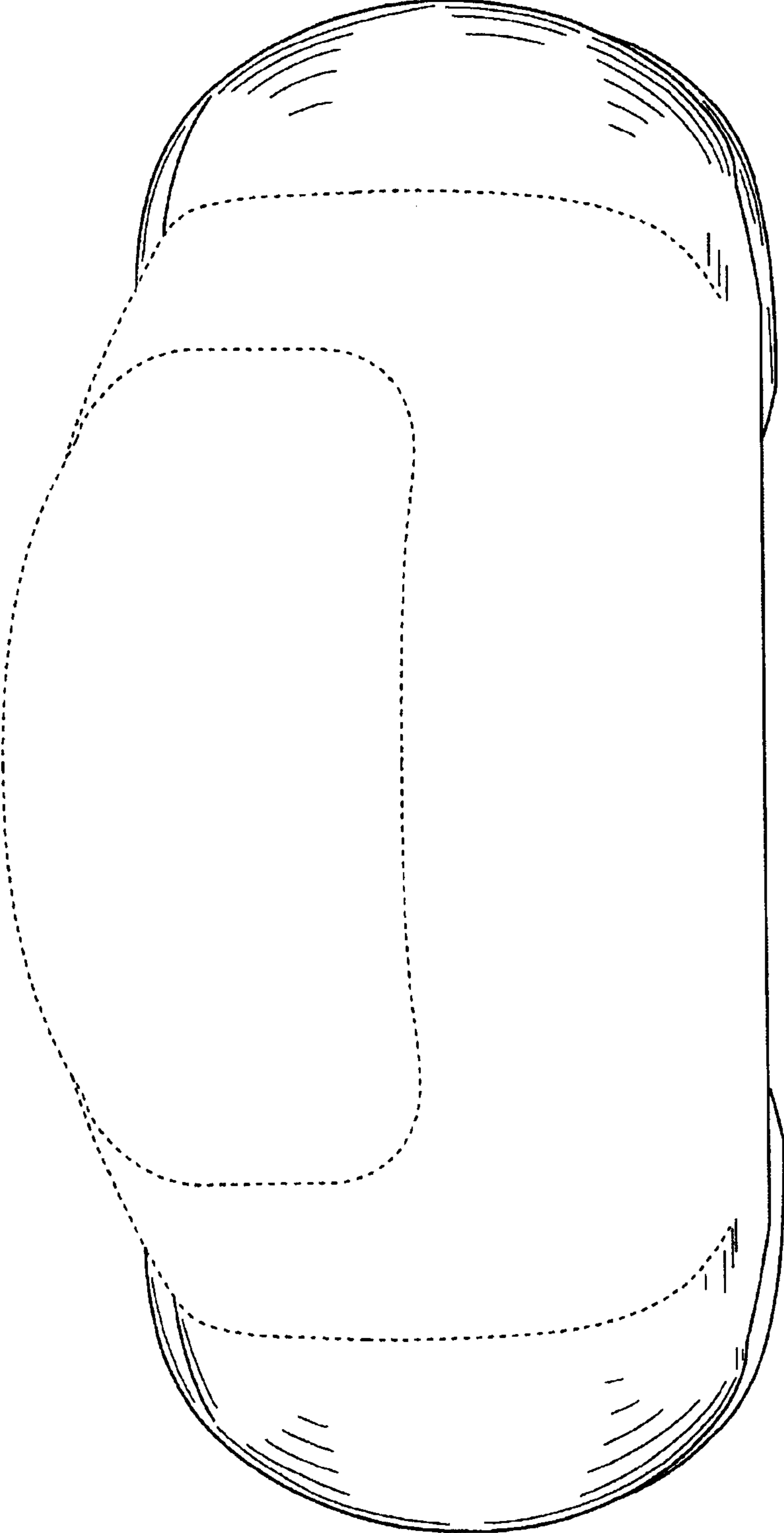




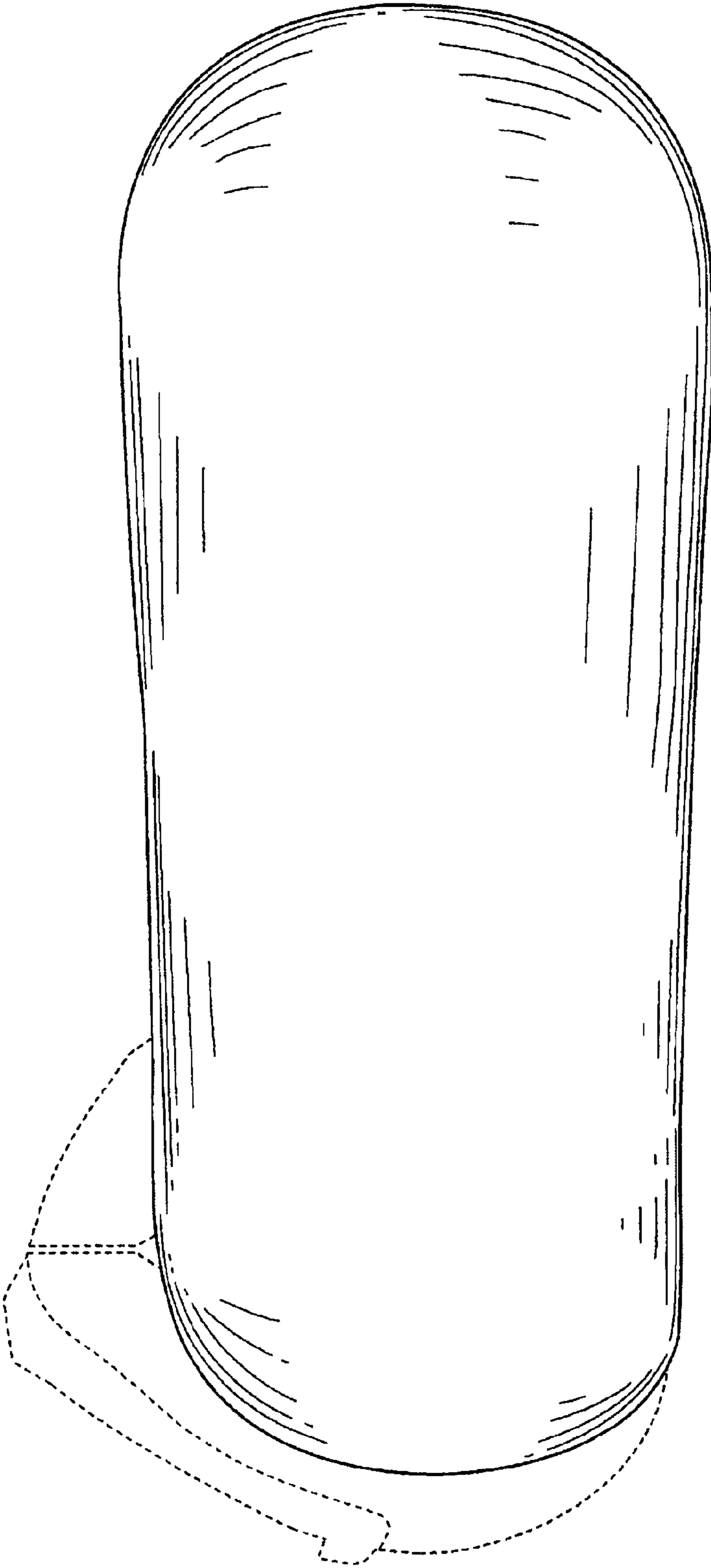
**FIG. 8**

FIG. 9

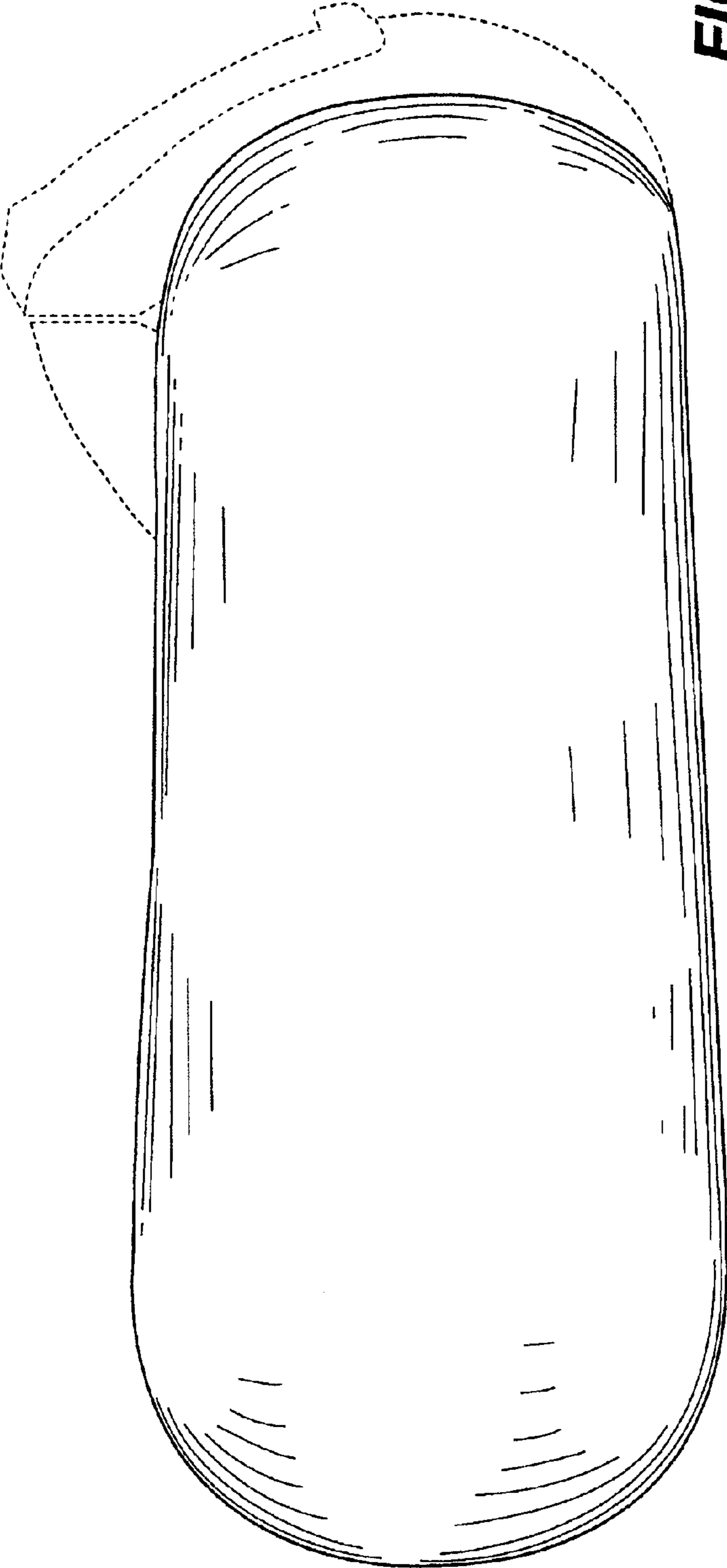




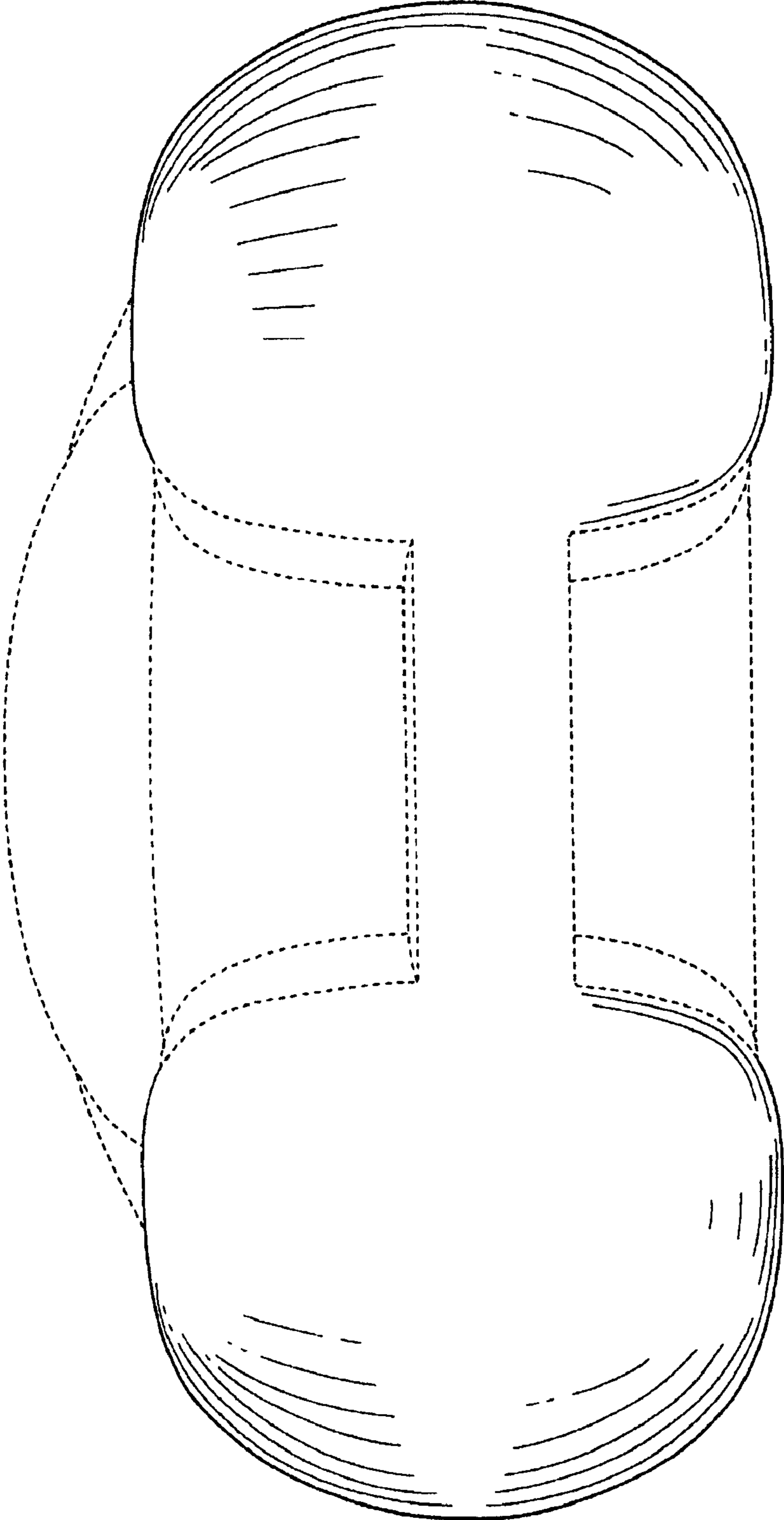
**FIG. 10**



**FIG. 11**

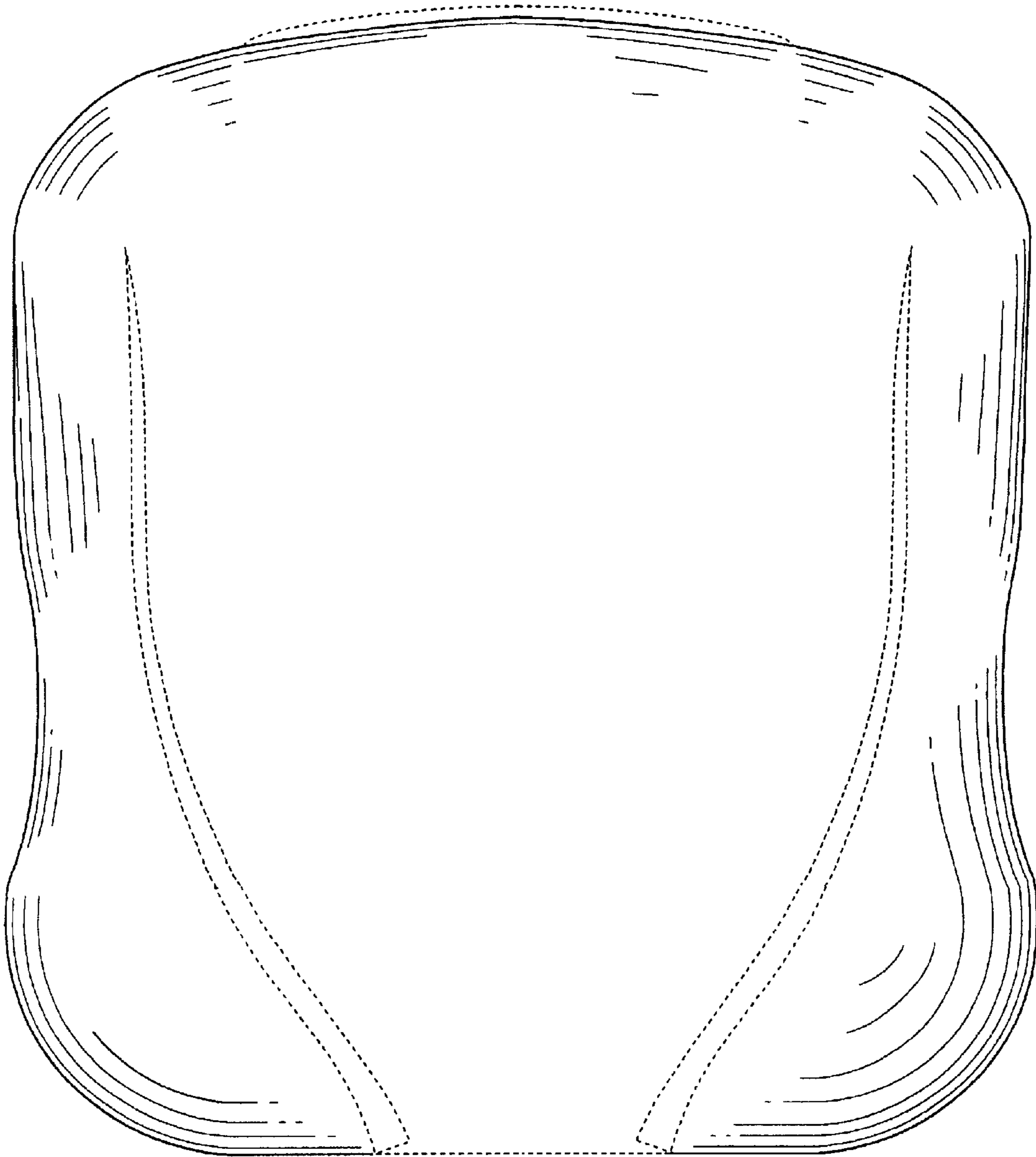


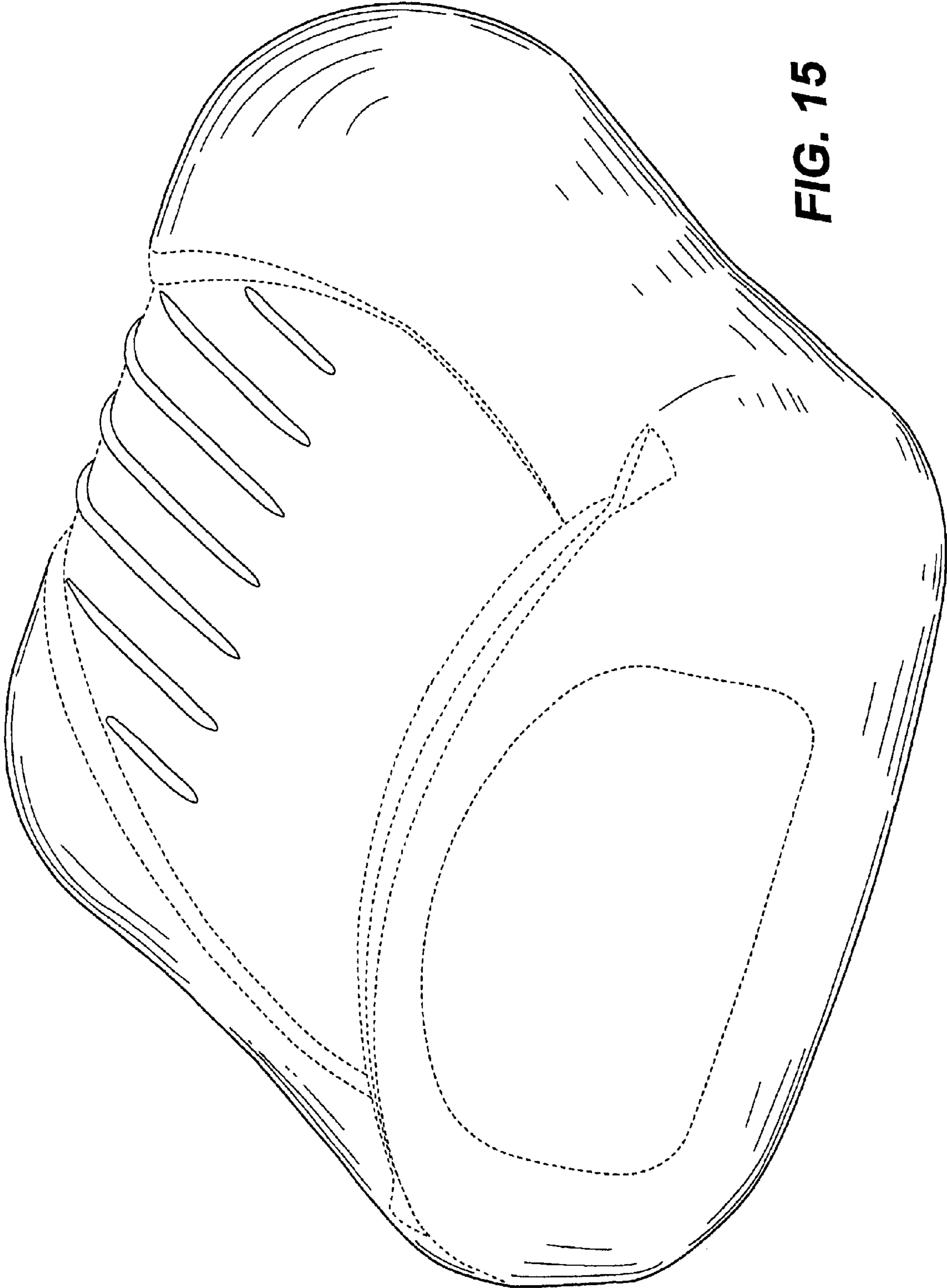
**FIG. 12**



**FIG. 13**

**FIG. 14**

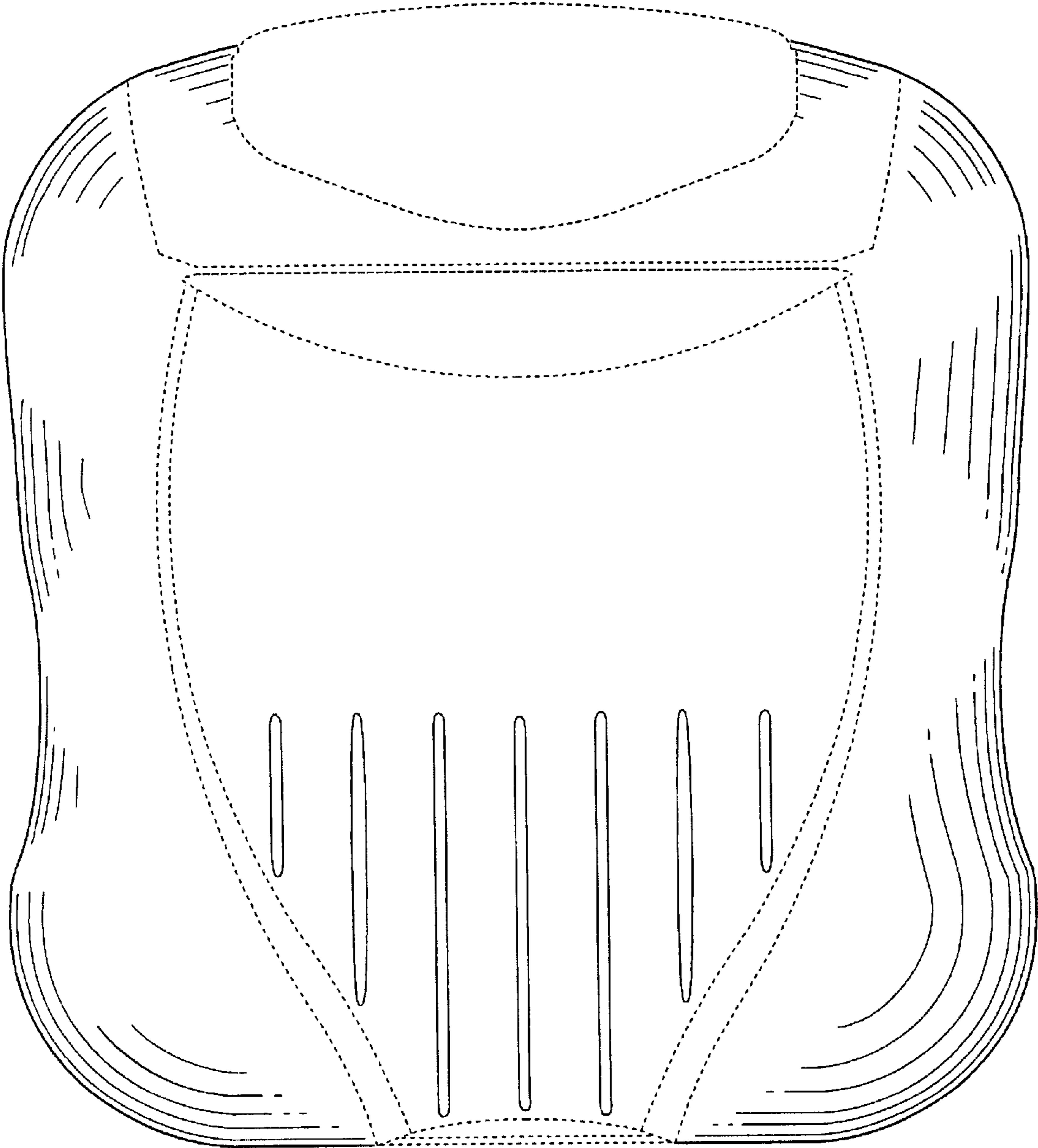


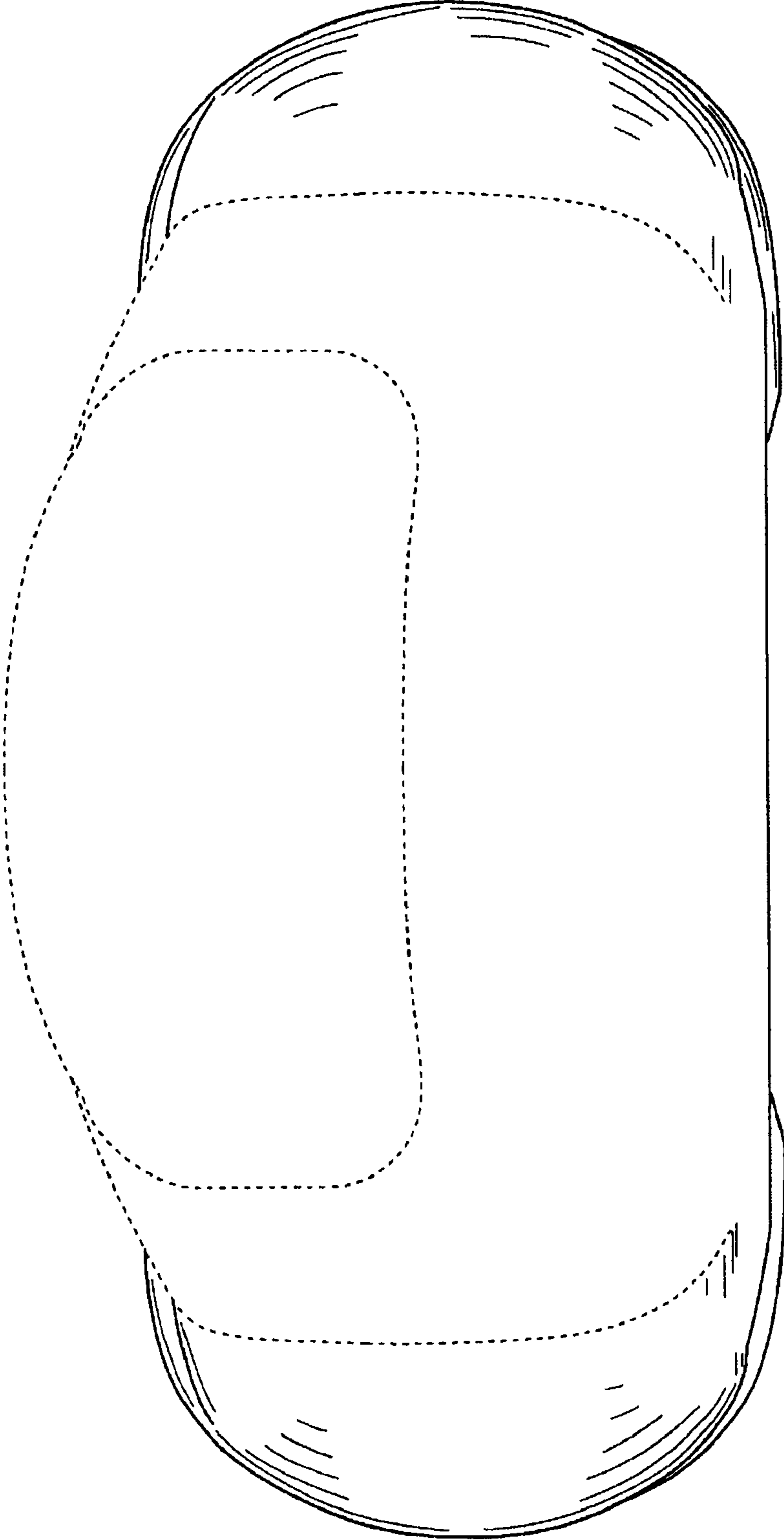


**FIG. 15**



FIG. 16

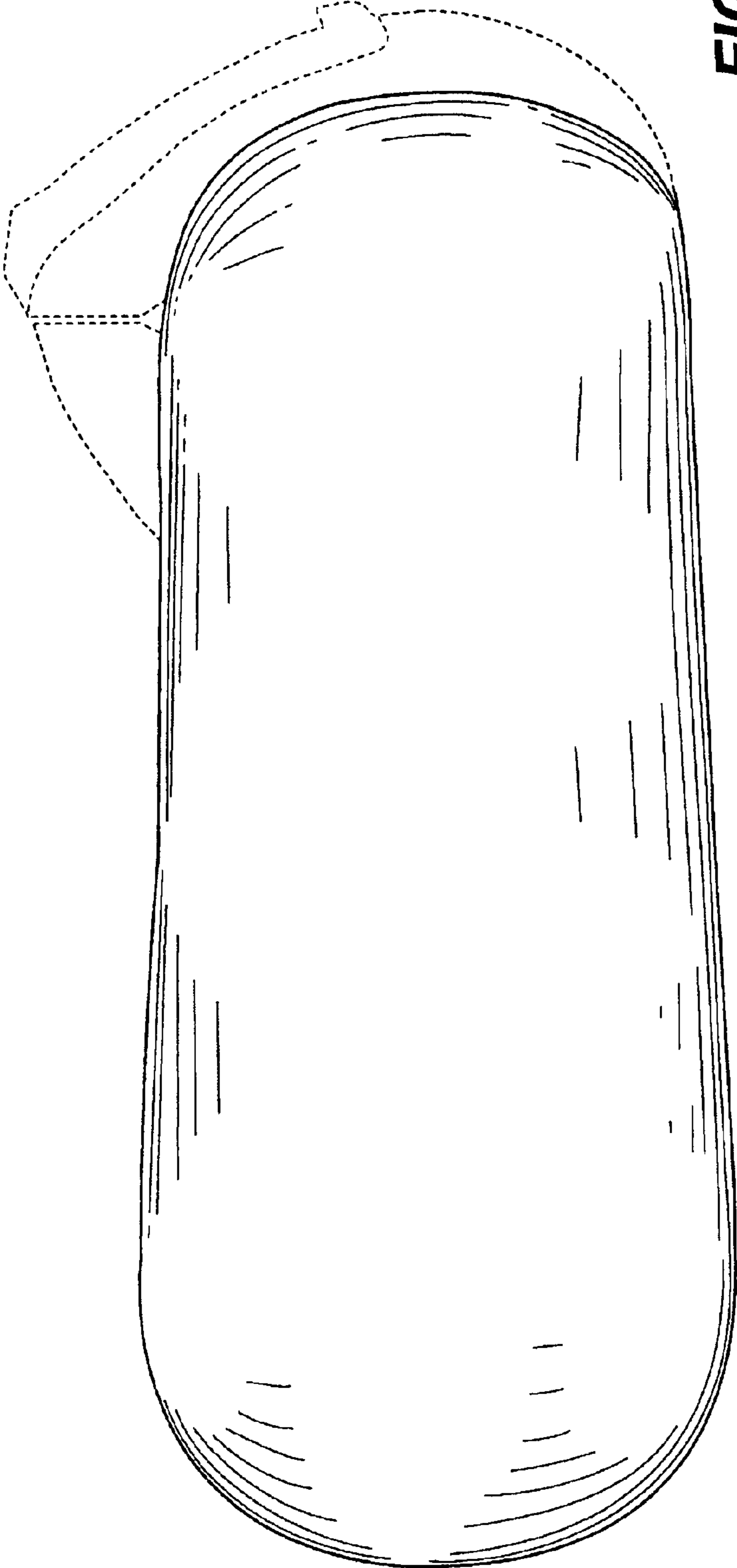




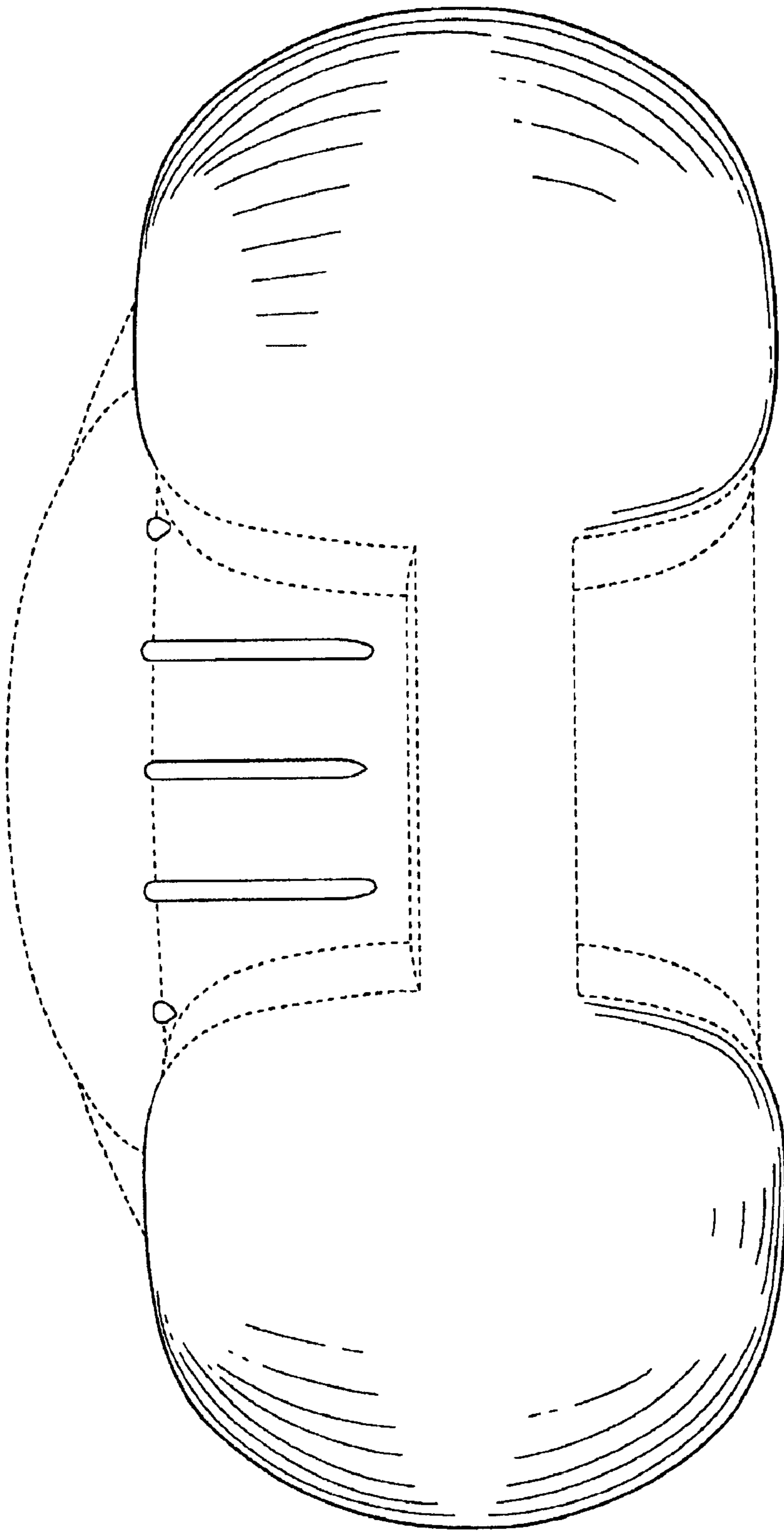
**FIG. 17**



**FIG. 18**



**FIG. 19**



**FIG. 20**

FIG. 21

