



US00D531984S

(12) **United States Design Patent**
Koss et al.

(10) **Patent No.: US D531,984 S**

(45) **Date of Patent: ** *Nov. 14, 2006**

- (54) **STEREO HEADPHONE EARPLATE**
- (75) Inventors: **Michael J. Koss**, River Hills, WI (US);
Mandy M. Johnson, Milwaukee, WI (US)
- (73) Assignee: **Koss Corporation**, Milwaukee, WI (US)

3,829,624 A	8/1974	Goodin et al.	
3,875,592 A	* 4/1975	Aileo	2/209
D237,307 S	* 10/1975	Miyamoto et al.	D14/192
4,418,248 A	* 11/1983	Mathis	381/373
4,499,593 A	* 2/1985	Antle	381/378
4,829,571 A	* 5/1989	Kakiuchi et al.	381/309
D410,466 S	* 6/1999	Mouri	D14/205
6,006,115 A	* 12/1999	Wingate	455/575.2
D517,044 S	* 3/2006	Koss et al.	D14/205

(*) Notice: This patent is subject to a terminal disclaimer.

* cited by examiner

(**) Term: **14 Years**

Primary Examiner—Paula A. Greene

(21) Appl. No.: **29/224,431**

(22) Filed: **Mar. 2, 2005**

(57) **CLAIM**

The ornamental design for a stereo headphone earplate, as shown and described.

- (51) **LOC (8) Cl.** **14-01**
- (52) **U.S. Cl.** **D14/205**
- (58) **Field of Classification Search** D14/205,
D14/206, 223, 224, 249, 156, 159, 167, 168,
D14/192; 181/129, 130, 135, 137, 175; 379/430,
379/433, 447, 368, 110.1; 455/575.2; 381/309,
381/379, 371, 381, 374, 378; 2/209; D29/112
See application file for complete search history.

DESCRIPTION

FIG. 1 is a front perspective view of stereo headphone earplate showing our new design;
 FIG. 2 is a front view thereof;
 FIG. 3 is a right side elevational view thereof;
 FIG. 4 is a left side elevational view thereof;
 FIG. 5 is a top plan view thereof;
 FIG. 6 is a bottom view thereof; and,
 FIG. 7 is a rear view thereof.

The broken lines are for illustrative purposes only and form no part of the claimed design.

(56) **References Cited**

U.S. PATENT DOCUMENTS

- 3,614,344 A 10/1971 Gorike
- 3,661,225 A * 5/1972 Anderson 181/175

1 Claim, 3 Drawing Sheets

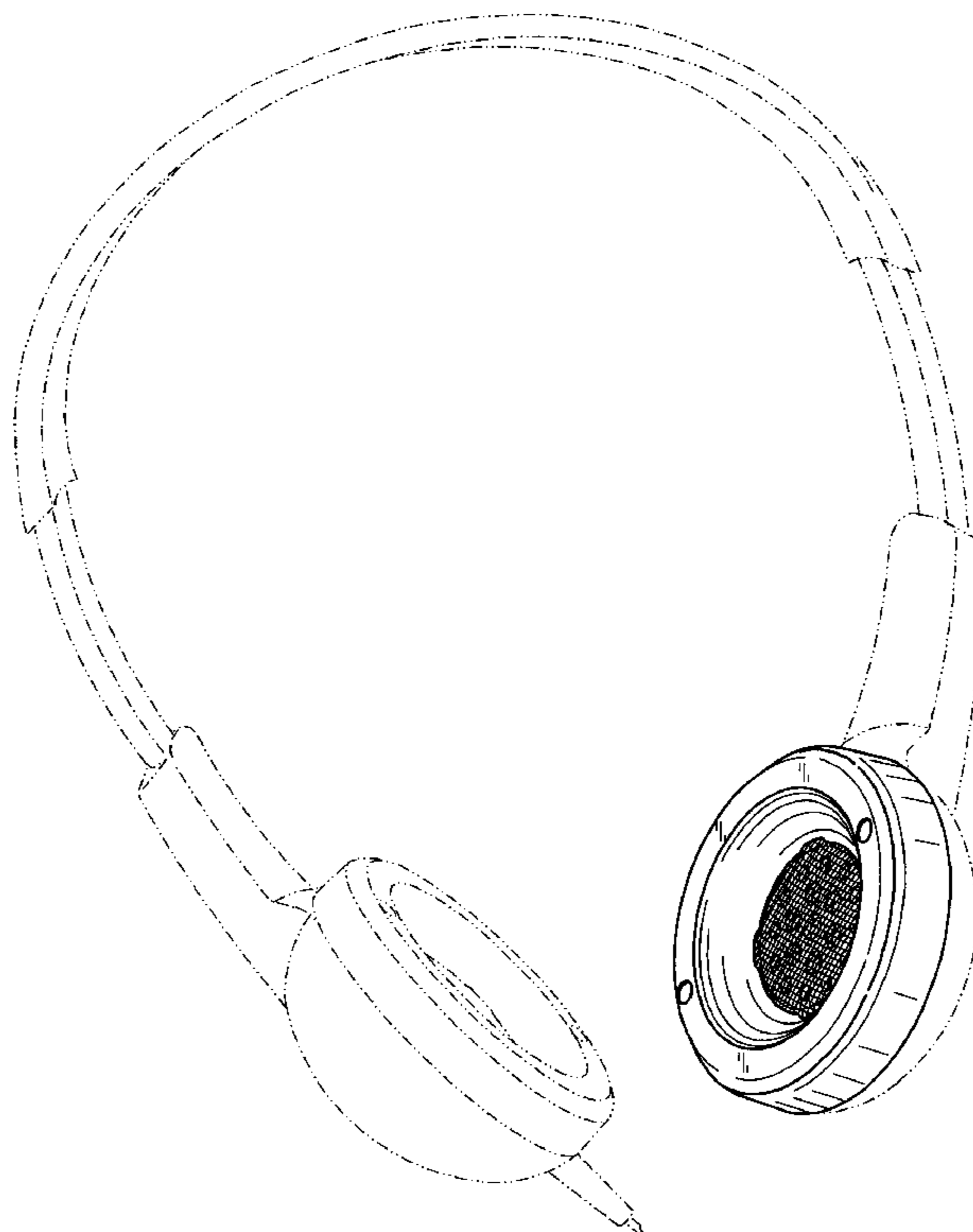

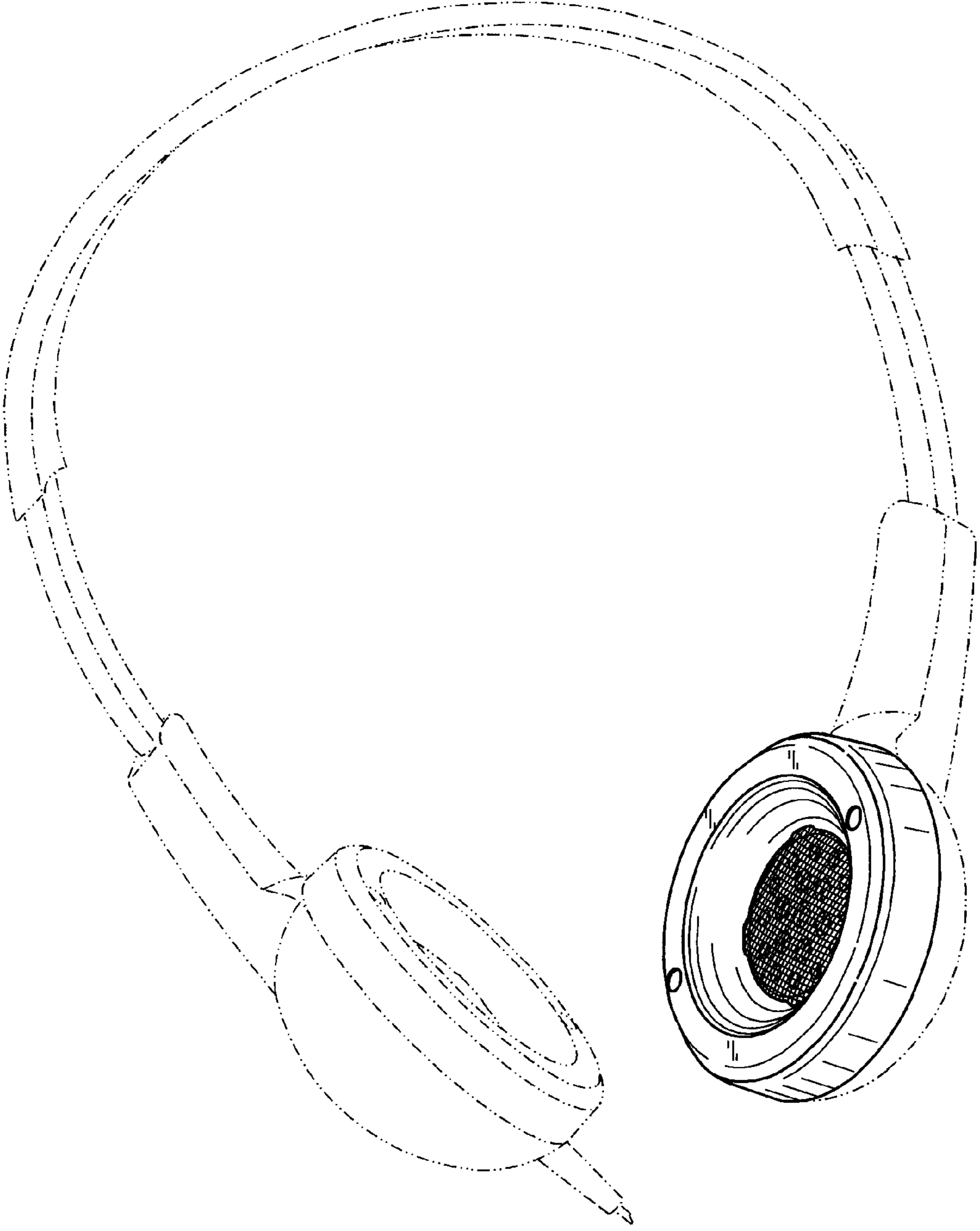

FIG. 1

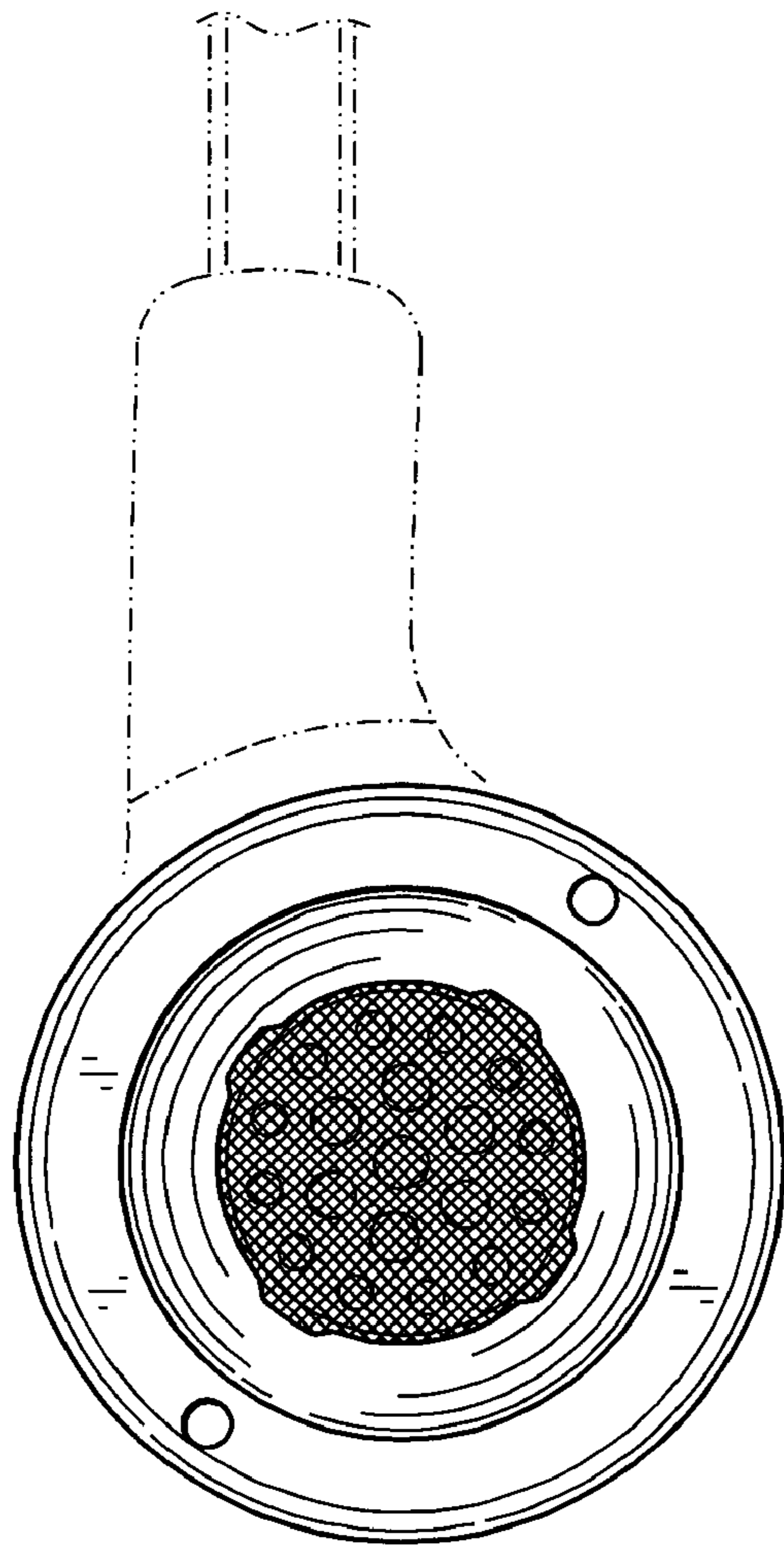

FIG. 2

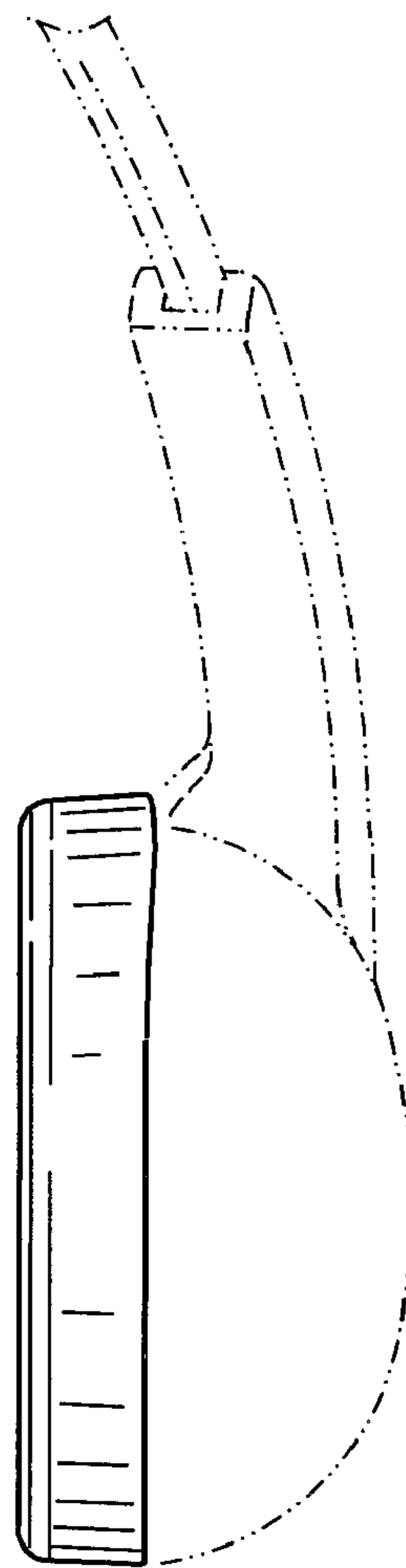

FIG. 3

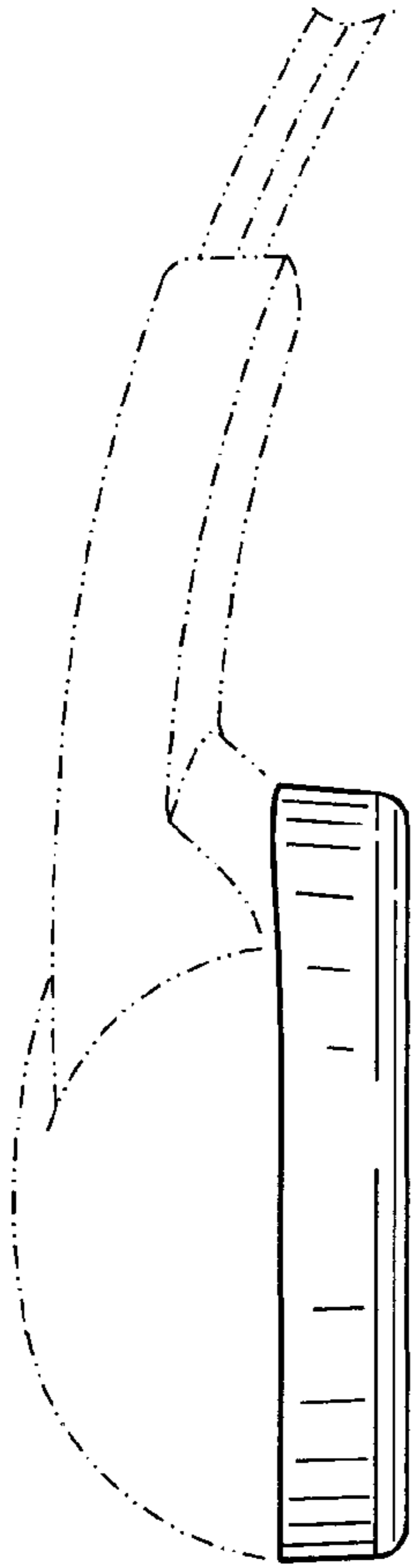

FIG. 4

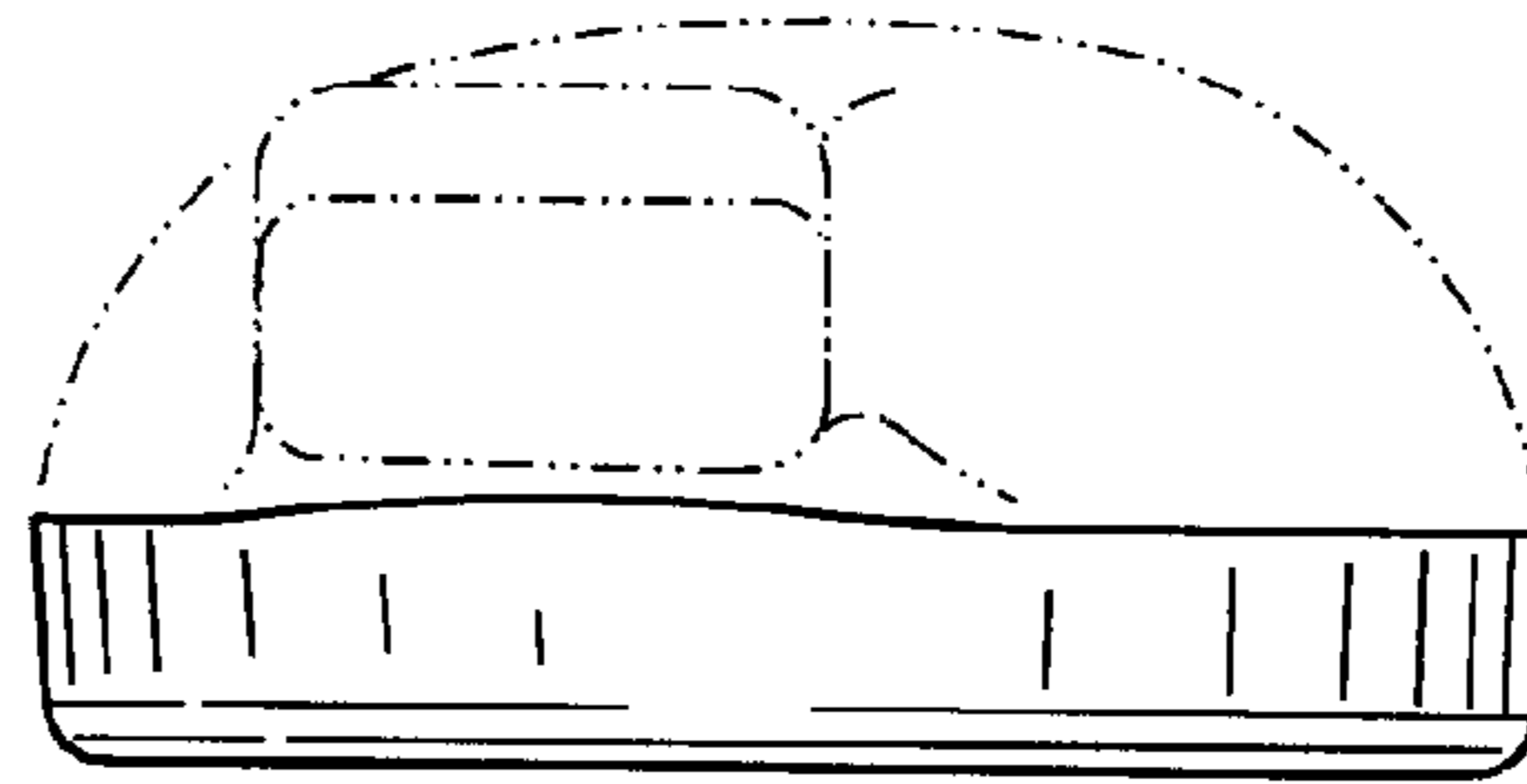

FIG. 5

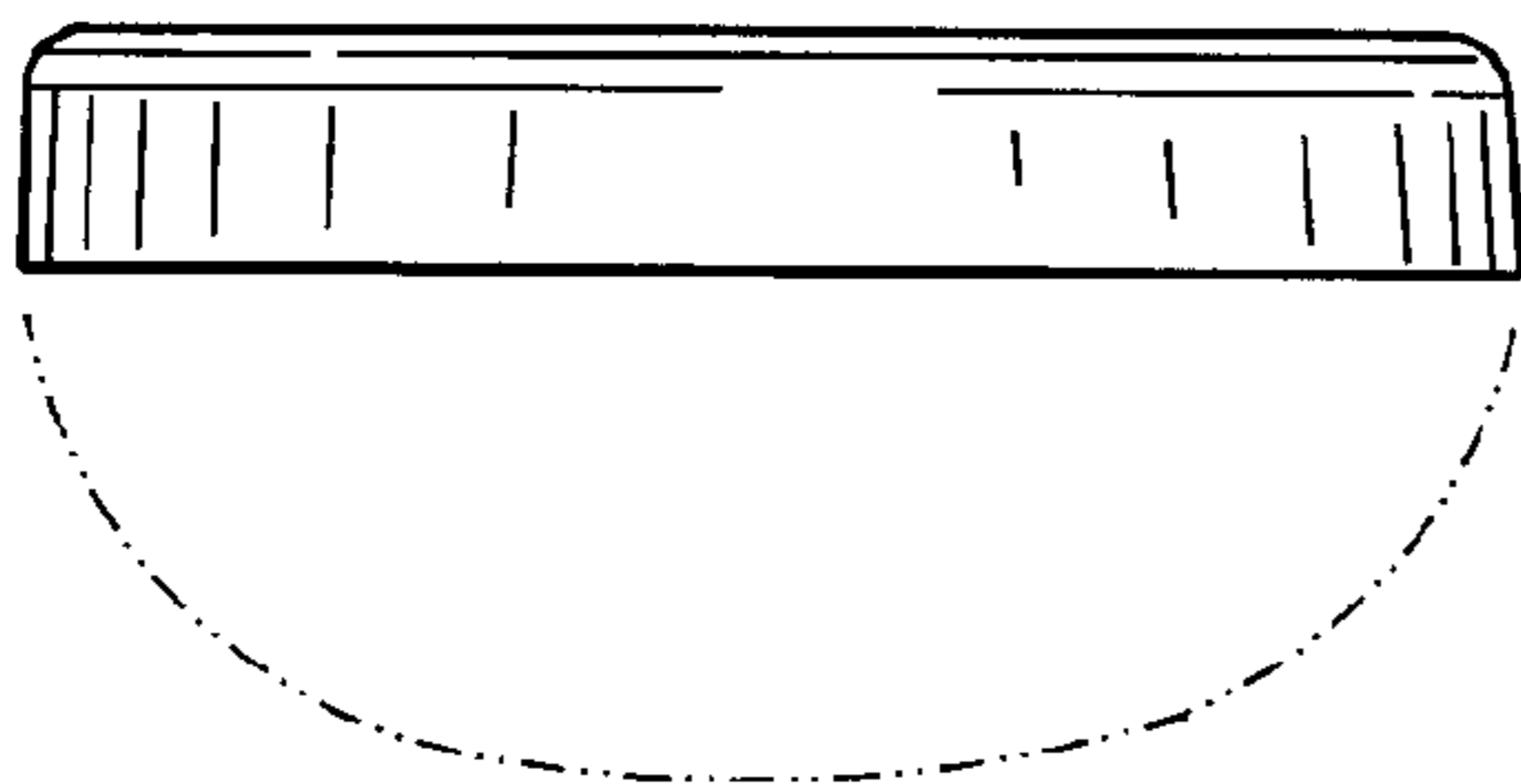

FIG. 6

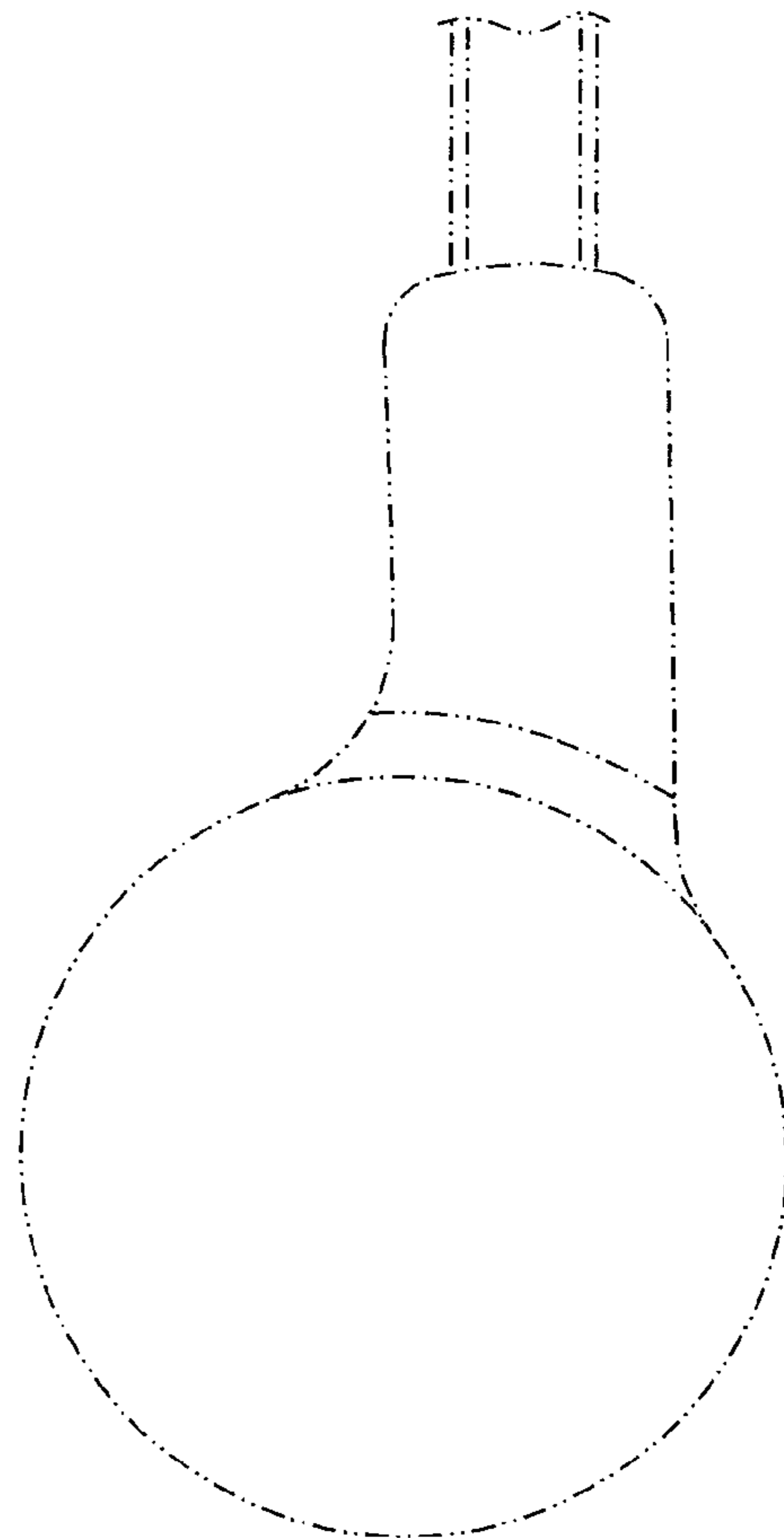

FIG. 7