



US00D531974S

(12) **United States Design Patent**  
**Kim et al.**

(10) **Patent No.:** **US D531,974 S**

(45) **Date of Patent:** **\*\* Nov. 14, 2006**

(54) **PORTABLE PHONE**

(75) Inventors: **Young-Sae Kim**, Palo Alto, CA (US);  
**Chi-Young Ahn**, Seodaemun-Gu (KR);  
**Beom-Ku Han**, Seoul (KR);  
**Chang-Hwan Hwang**, Goyang-Si (KR)

(73) Assignee: **Samsung Electronics Co., Ltd.**,  
Suwon-si (KR)

(\*\*) Term: **14 Years**

(21) Appl. No.: **29/234,737**

(22) Filed: **Jul. 22, 2005**

(30) **Foreign Application Priority Data**

Jan. 26, 2005 (KR) ..... 30-2005-0002652

(51) **LOC (8) Cl.** ..... **14-03**

(52) **U.S. Cl.** ..... **D14/138**

(58) **Field of Classification Search** ..... D14/137,  
D14/138, 147-148, 247-248, 144, 496, 156,  
D14/341-347; 379/433.01-433.13; 348/14.02,  
348/14.01, 376; 455/575.4, 566, 575.1, 556.1,  
455/556.2, 90.3; D21/329, 331, 333; D16/208  
See application file for complete search history.

(56) **References Cited**

**U.S. PATENT DOCUMENTS**

D401,577 S	*	11/1998	Yamaguchi	.....	D14/138
D469,367 S	*	1/2003	Mirabelli et al.	.....	D10/65
6,549,789 B1	*	4/2003	Kfoury	.....	455/550.1
D480,697 S	*	10/2003	Lee et al.	.....	D14/138
D495,674 S	*	9/2004	Yoo et al.	.....	D14/138
D496,643 S	*	9/2004	Yoo et al.	.....	D14/138
D502,162 S	*	2/2005	Kim et al.	.....	D14/138
D502,454 S	*	3/2005	Lee	.....	D14/138
D502,932 S	*	3/2005	Minamide	.....	D14/138
D503,171 S	*	3/2005	Park et al.	.....	D14/346
D505,407 S	*	5/2005	Itano	.....	D14/138
D508,687 S	*	8/2005	Lee	.....	D14/138
D508,903 S	*	8/2005	Kim et al.	.....	D14/138
D509,206 S	*	9/2005	Jang	.....	D14/138
D521,481 S	*	5/2006	Shin	.....	D14/138

7,043,284 B1	*	5/2006	Tornaghi	.....	455/575.1
7,055,219 B1	*	6/2006	Shiba	.....	16/367
2002/0102946 A1	*	8/2002	SanGiovanni	.....	455/90
2003/0064758 A1	*	4/2003	Mizuta et al.	.....	455/566
2003/0078069 A1	*	4/2003	Lindeman	.....	455/550
2004/0121825 A1	*	6/2004	Ma et al.	.....	455/575.4
2004/0132482 A1	*	7/2004	Kang et al.	.....	455/550.1
2004/0192422 A1	*	9/2004	Watanabe et al.	.....	455/575.3

(Continued)

**OTHER PUBLICATIONS**

Samsung P730 telephone, announced Mar. 2004, [online], [retrieved on Jun. 5, 2006]. Retrieved from Internet , URL:http://www.gsmarena.com>.\*

Philips 968 telephone, announced Jul. 2005, [online], [retrieved on Jun. 5, 2006]. Retrieved from Internet , URL:http://www.gsmarena.com>.\*

Sagem MY C-4 telephone, announced 3<sup>rd</sup> quarter 2004, [online], [retrieved on Jun. 5, 2006]. Retrieved from Internet ,URL:http://www.gsmarena.com>.\*

Nokia N90 telephone, announced 2<sup>nd</sup> quarter 2005, [online], [retrieved on Jun. 7, 2006]. Retrieved from Internet , URL:http://www.gsmarena.com>.\*

*Primary Examiner*—Jeffrey Asch

(74) *Attorney, Agent, or Firm*—Staas & Halsey LLP

(57) **CLAIM**

The ornamental design for the portable phone, as shown and described.

**DESCRIPTION**

FIG. 1 is a perspective view of the portable phone showing our design;

FIG. 2 is a front view thereof;

FIG. 3 is a rear view thereof;

FIG. 4 is a left side view thereof;

FIG. 5 is a right side view thereof;

FIG. 6 is a top plan view thereof;

FIG. 7 is a bottom plan view thereof;

FIG. 8 is an open view thereof; and,

FIG. 9 is another open view thereof.

**1 Claim, 6 Drawing Sheets**

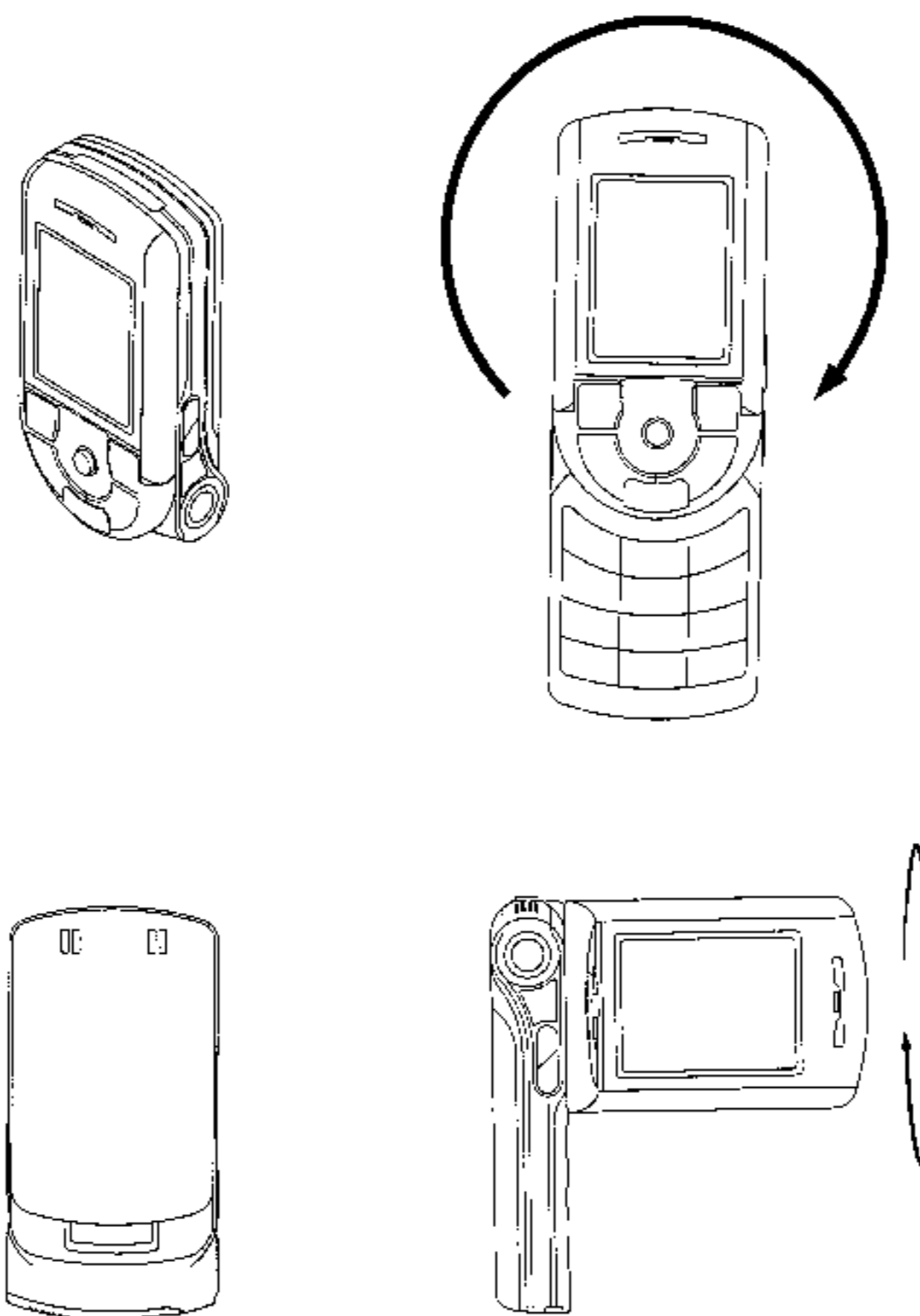

# US D531,974 S

Page 2

---

## U.S. PATENT DOCUMENTS

2004/0198460	A1 *	10/2004	Sakuta et al. ....	455/566	2005/0124397	A1 *	6/2005	Yamasaki .....	455/575.4
2004/0203535	A1 *	10/2004	Kim et al. ....	455/90.3	2005/0130718	A1 *	6/2005	Woo .....	455/575.3
2004/0224730	A1 *	11/2004	Sakai et al. ....	455/575.3	2005/0202856	A1 *	9/2005	Park et al. ....	455/575.1
2004/0248628	A1 *	12/2004	Taninai .....	455/575.3	2005/0215298	A1 *	9/2005	Lee .....	455/575.4
2004/0266477	A1 *	12/2004	Murata .....	455/556.1	2005/0250532	A1 *	11/2005	Hwang et al. ....	455/550.1
2005/0107126	A1 *	5/2005	Kim .....	455/565	2006/0019726	A1 *	1/2006	Park et al. ....	455/575.1
2005/0124394	A1 *	6/2005	Kim et al. ....	455/575.3					

\* cited by examiner

**FIG. 1**

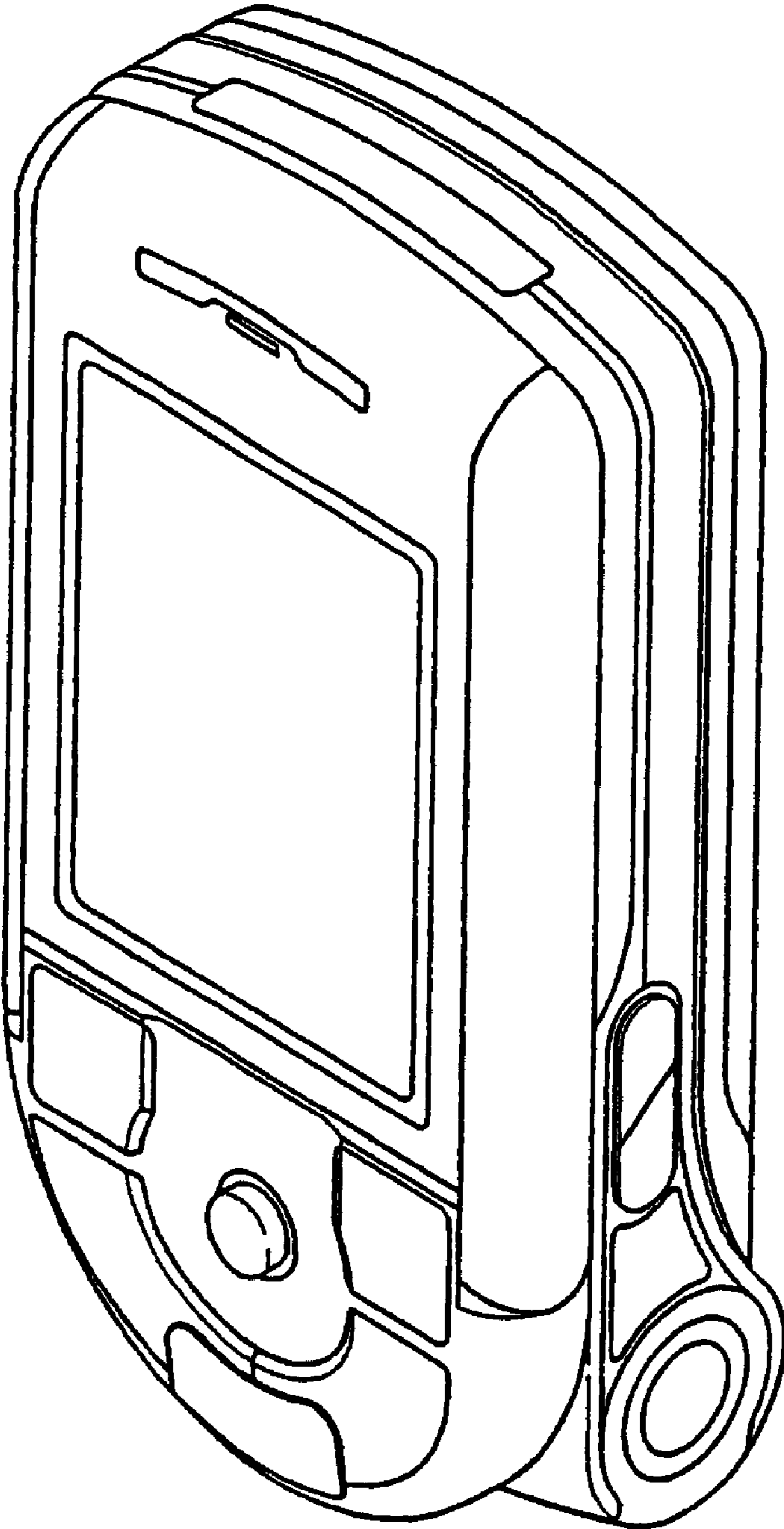

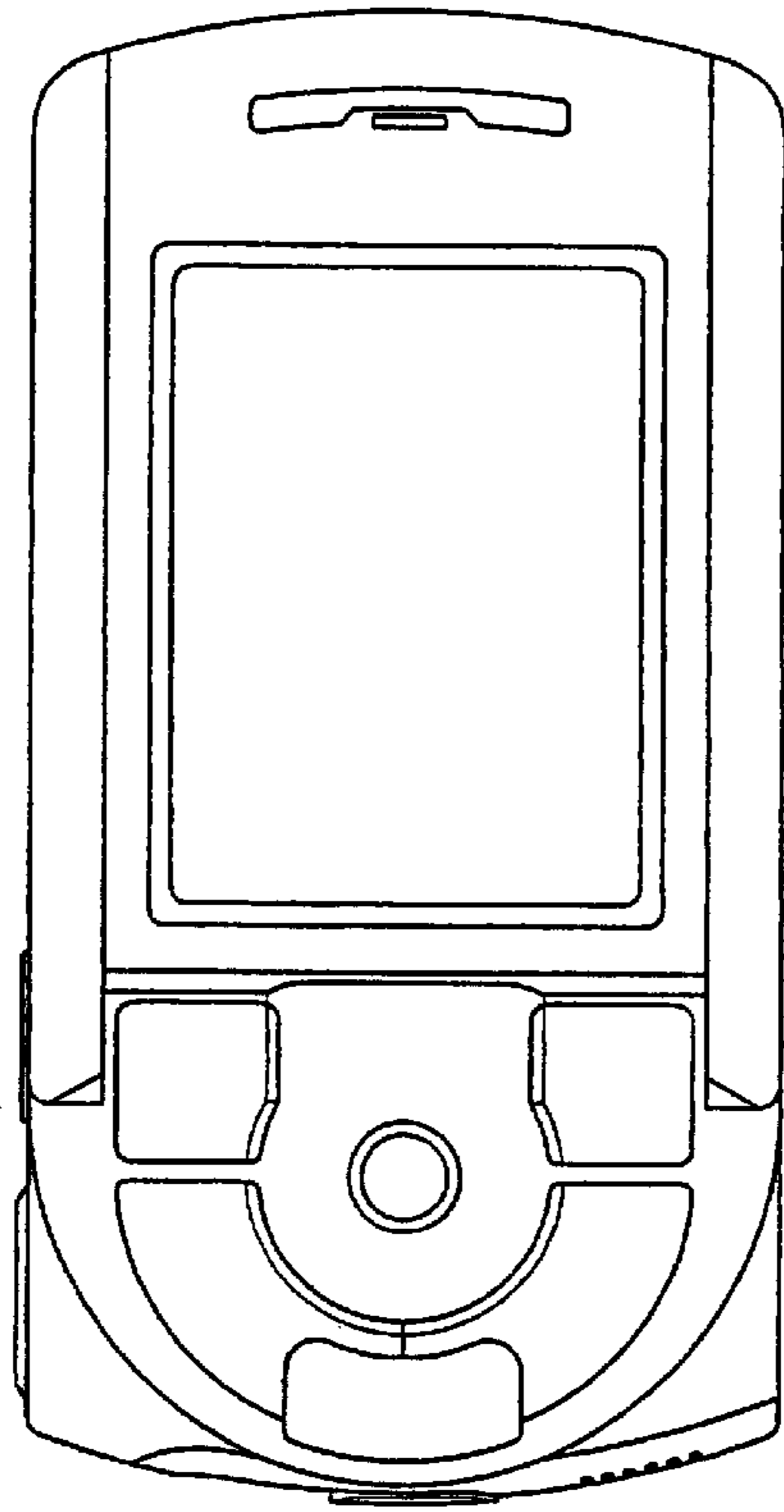

FIG. 2

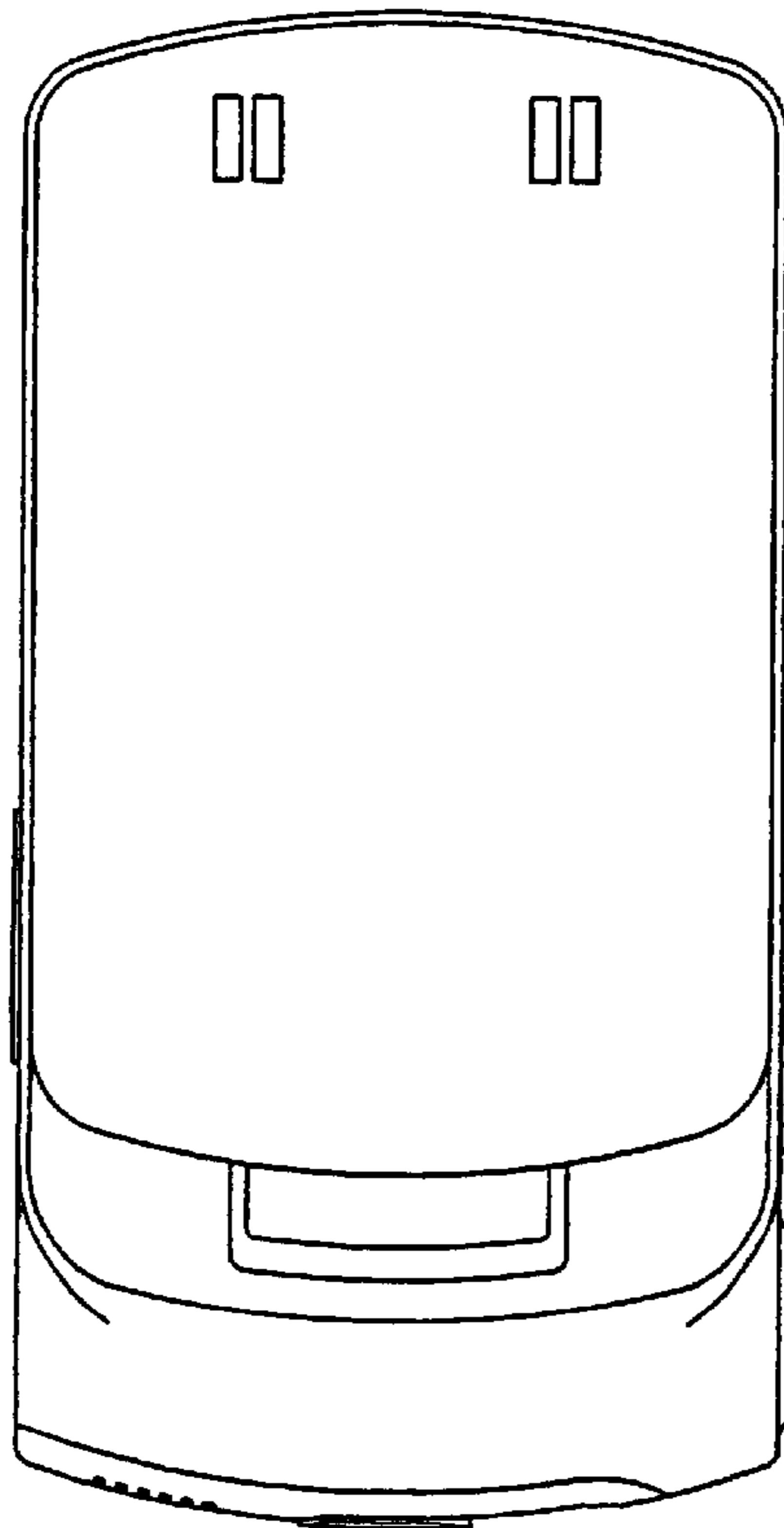

FIG. 3

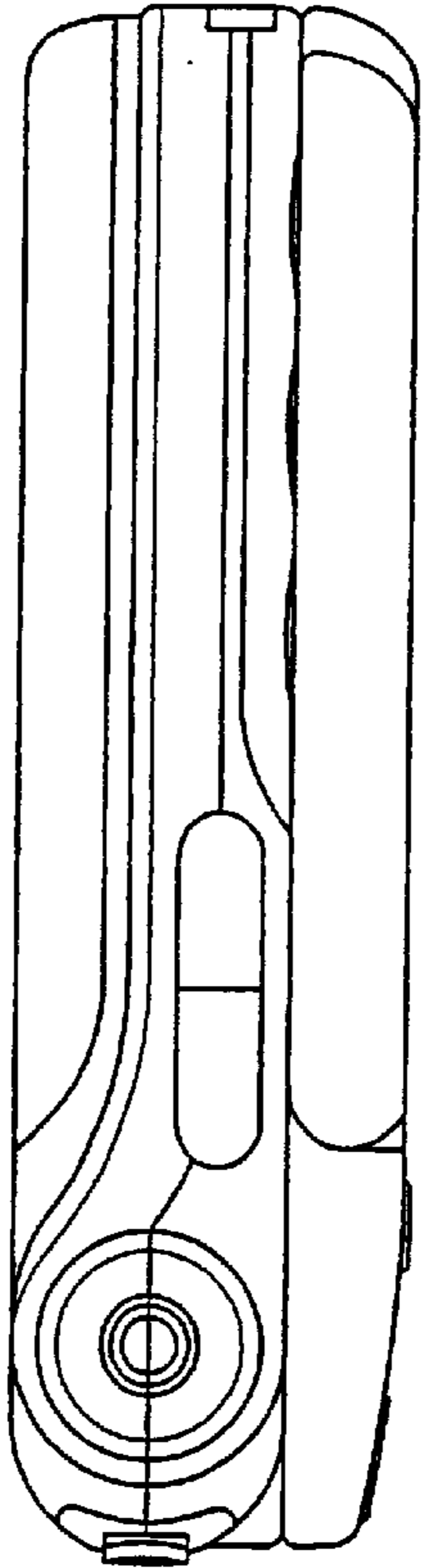

FIG. 4

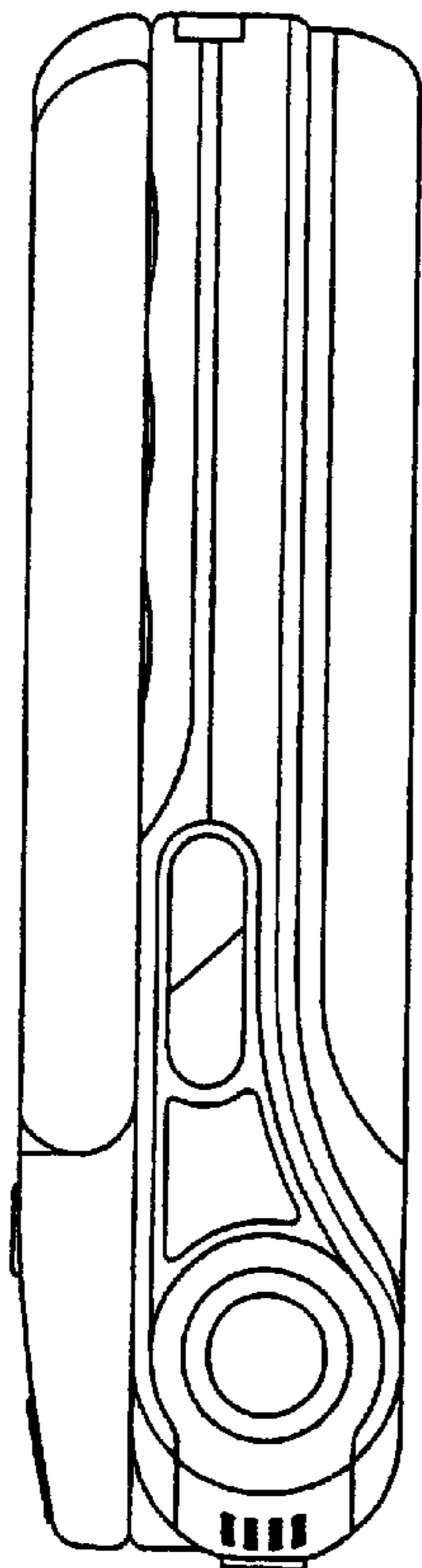
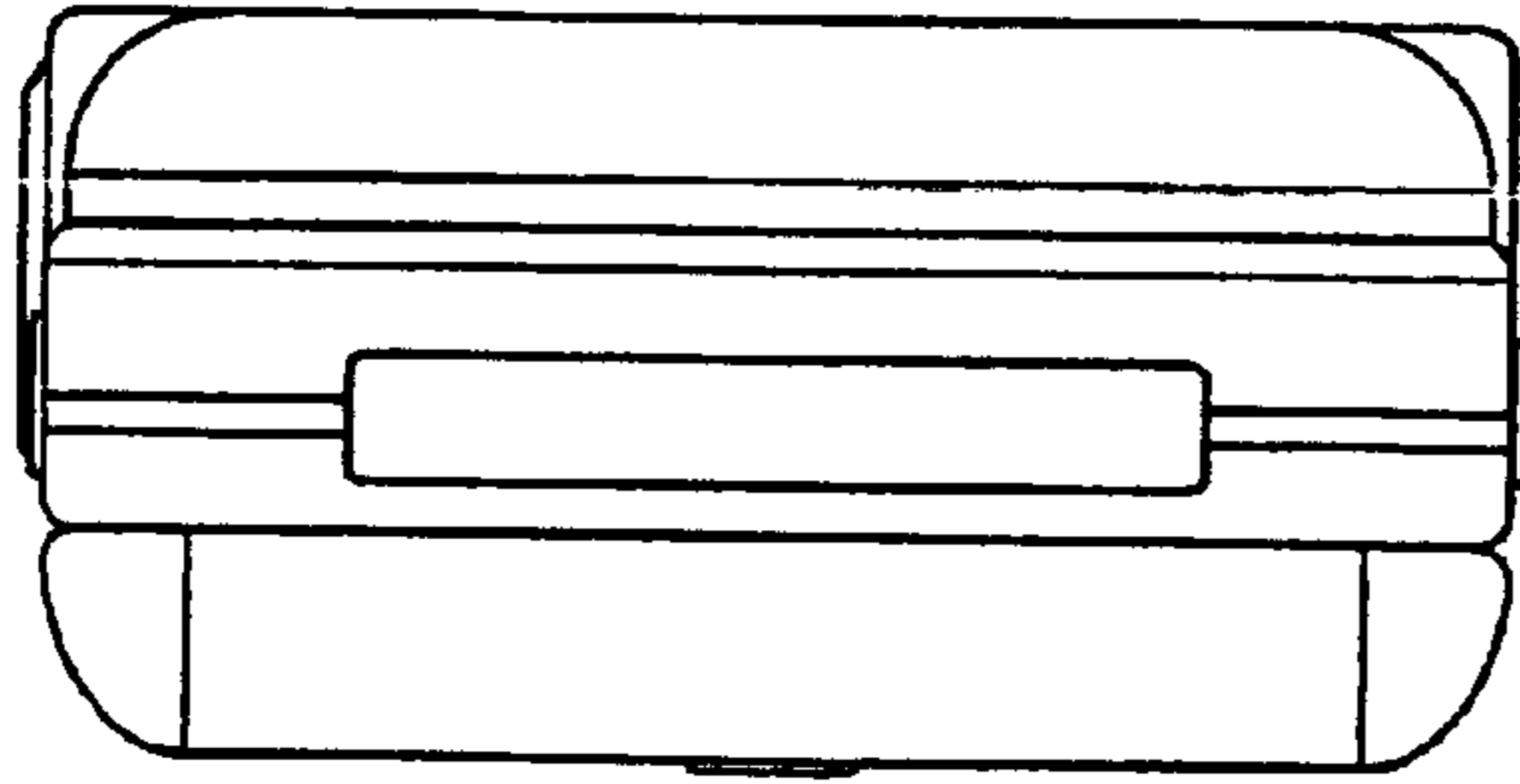
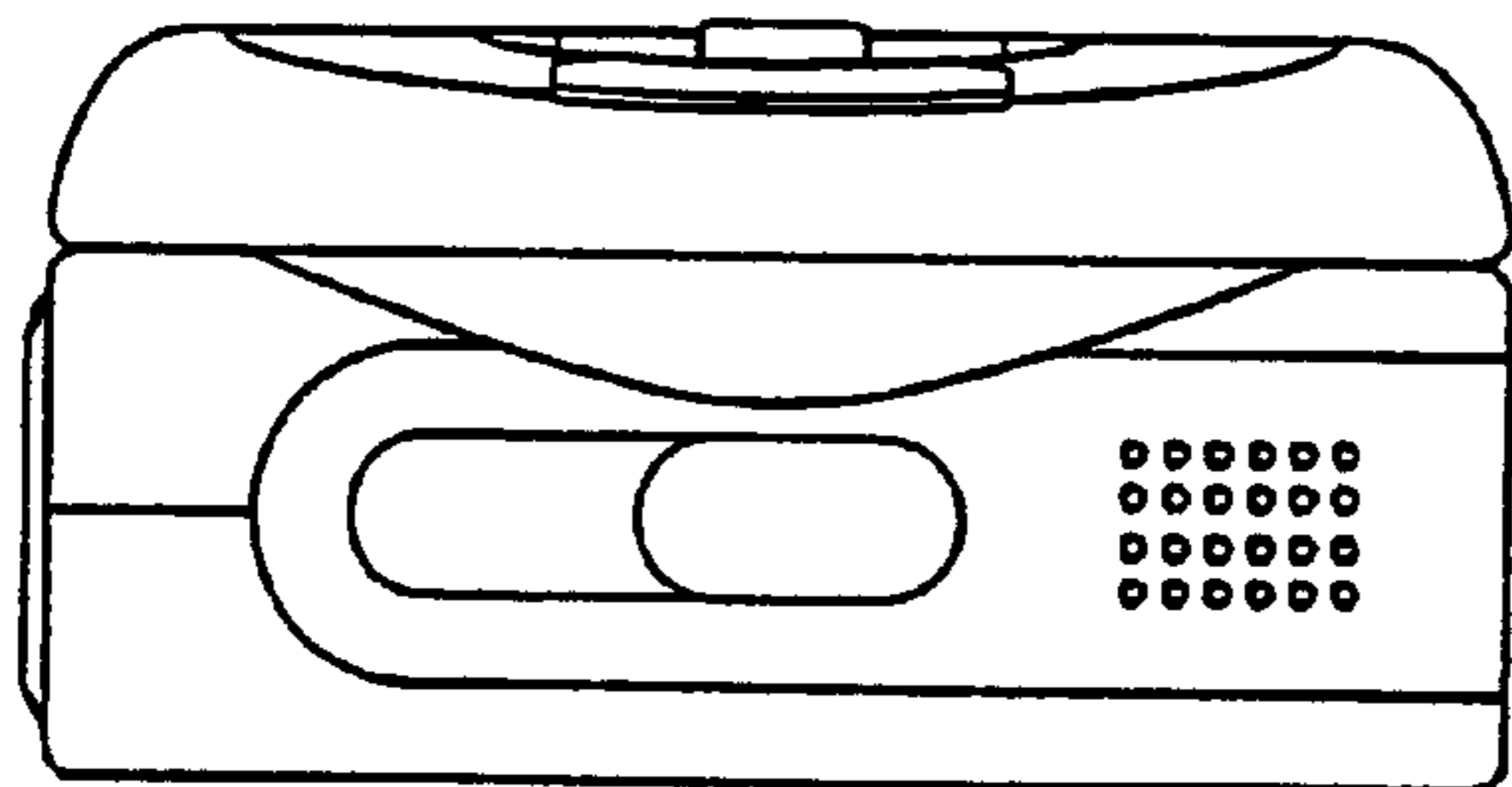

FIG. 5



**FIG. 6**



**FIG. 7**



FIG. 8

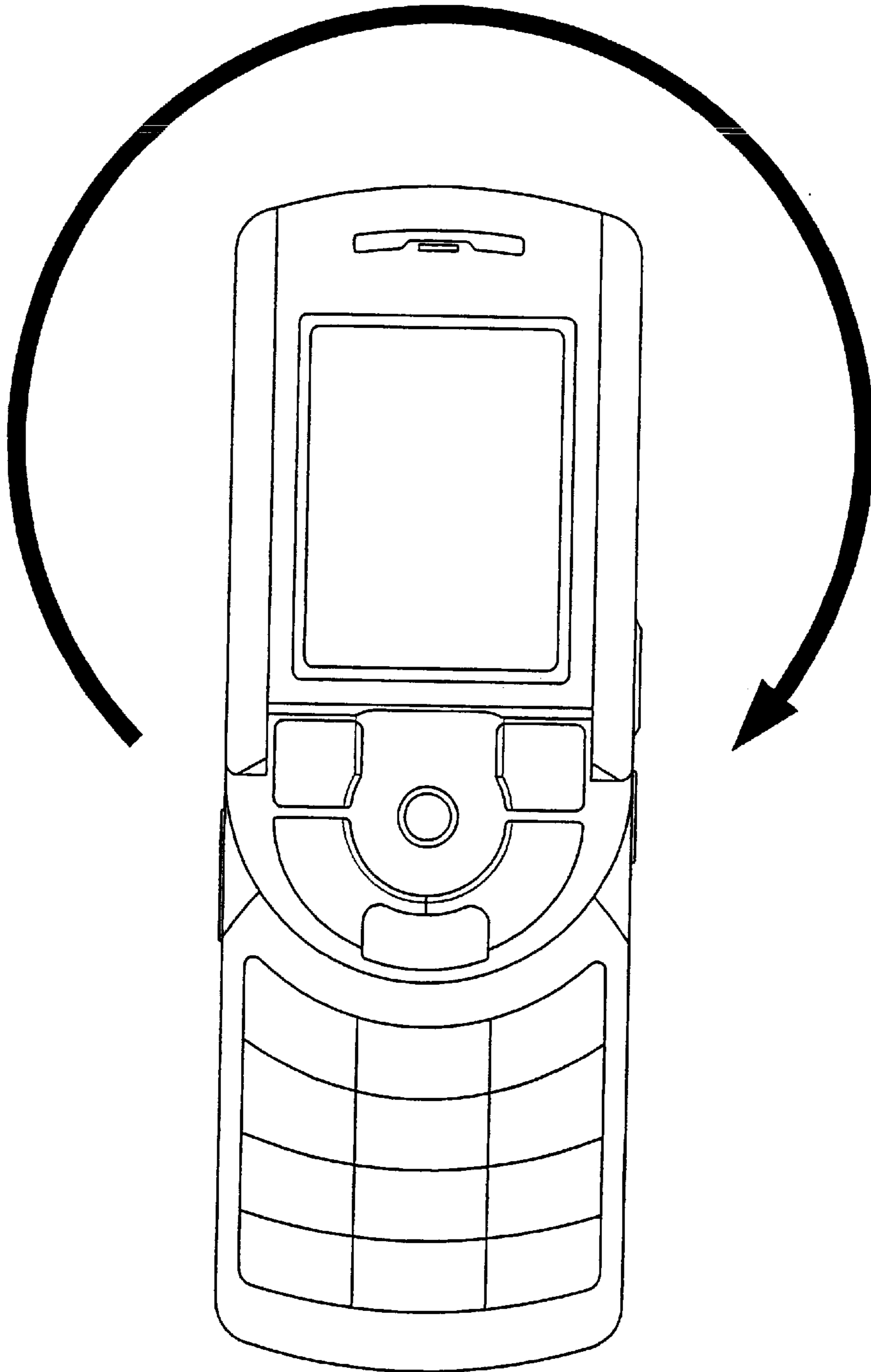

FIG. 9

