



US00D531973S

(12) **United States Design Patent** (10) **Patent No.:** **US D531,973 S**  
**Kim et al.** (45) **Date of Patent:** **\*\* Nov. 14, 2006**

(54) **PORTABLE PHONE**  
(75) Inventors: **Young-Sae Kim**, Palo Alto, CA (US);  
**Chi-Young Ahn**, Seodaemun-Gu (KR);  
**Beom-Ku Han**, Seoul (KR);  
**Chang-Hwan Hwang**, Goyang-Si (KR)  
(73) Assignee: **Samsung Electronics Co., Ltd.**,  
Suwon-Si (KR)

7,043,284 B1 \* 5/2006 Tornaghi ..... 455/575.1  
7,055,219 B1 \* 6/2006 Shiba ..... 16/367  
2002/0102946 A1 \* 8/2002 SanGiovanni ..... 455/90  
2003/0064758 A1 \* 4/2003 Mizuta et al. .... 455/566  
2003/0078069 A1 \* 4/2003 Lindeman ..... 455/550  
2004/0121825 A1 \* 6/2004 Ma et al. .... 455/575.4  
2004/0132482 A1 \* 7/2004 Kang et al. .... 455/550.1  
2004/0192422 A1 \* 9/2004 Watanabe et al. .... 455/575.3

(Continued)

(\*\*) Term: **14 Years**

**OTHER PUBLICATIONS**

(21) Appl. No.: **29/234,734**

Samsung P730 telephone, announced Mar. 2004, [online],  
[retrieved on Jun. 5, 2006]. Retrieved from Internet ,URL:  
<http://www.gsmarena.com>>.\*

(22) Filed: **Jul. 22, 2005**

Philips 968 telephone, announced Jul. 2005, [online], [re-  
trieved on Jun. 5, 2006]. Retrieved from Internet ,URL:  
<http://www.gsmarena.com>>.\*

(30) **Foreign Application Priority Data**

Jan. 26, 2005 (KR) ..... 30-2005-0002654

Sagem MY C-4 telephone, announced 3<sup>rd</sup> quarter 2004,  
[online], [retrieved on Jun. 5, 2006]. Retrieved from  
Internet ,URL: <http://www.gsmarena.com>>.\*

(51) **LOC (8) Cl.** ..... **14-03**

(52) **U.S. Cl.** ..... **D14/138**

(58) **Field of Classification Search** ..... D14/137,  
D14/138, 147-148, 247-248, 144, 496, 156,  
D14/341-347; 379/433.01-433.13; 348/14.02,  
348/14.01, 376; 455/575.4, 566, 575.1, 556.1,  
455/556.2, 90.3; D21/329, 331, 333; D16/208  
See application file for complete search history.

Nokia N90 telephone, announced 2<sup>nd</sup> quarter 2005, [online],  
[retrieved on Jun. 5, 2006]. Retrieved from Internet ,URL:  
<http://www.gsmarena.com>>.\*

*Primary Examiner*—Jeffrey Asch  
(74) *Attorney, Agent, or Firm*—Staas & Halsey LLP

(56) **References Cited**

(57) **CLAIM**

**U.S. PATENT DOCUMENTS**

The ornamental design for the portable phone, as shown and  
described.

- D401,577 S \* 11/1998 Yamaguchi ..... D14/138
- D469,367 S \* 1/2003 Mirabelli et al. .... D10/65
- 6,549,789 B1 \* 4/2003 Kfoury ..... 455/550.1
- D480,697 S \* 10/2003 Lee et al. .... D14/138
- D495,674 S \* 9/2004 Yoo et al. .... D14/138
- D496,643 S \* 9/2004 Yoo et al. .... D14/138
- D502,162 S \* 2/2005 Kim et al. .... D14/138
- D502,454 S \* 3/2005 Lee ..... D14/138
- D502,932 S \* 3/2005 Minamide ..... D14/138
- D503,171 S \* 3/2005 Park et al. .... D14/346
- D505,407 S \* 5/2005 Itano ..... D14/138
- D508,687 S \* 8/2005 Lee ..... D14/138
- D508,903 S \* 8/2005 Kim et al. .... D14/138
- D509,206 S \* 9/2005 Jang ..... D14/138
- D521,481 S \* 5/2006 Shin ..... D14/138

**DESCRIPTION**

FIG. 1 is a perspective view of the portable phone showing  
our design;  
FIG. 2 is a front view thereof;  
FIG. 3 is a rear view thereof;  
FIG. 4 is a left side view thereof;  
FIG. 5 is a right side view thereof;  
FIG. 6 is a top plan view thereof;  
FIG. 7 is a bottom plan view thereof;  
FIG. 8 is an open view thereof; and,  
FIG. 9 is another open view thereof.

**1 Claim, 6 Drawing Sheets**

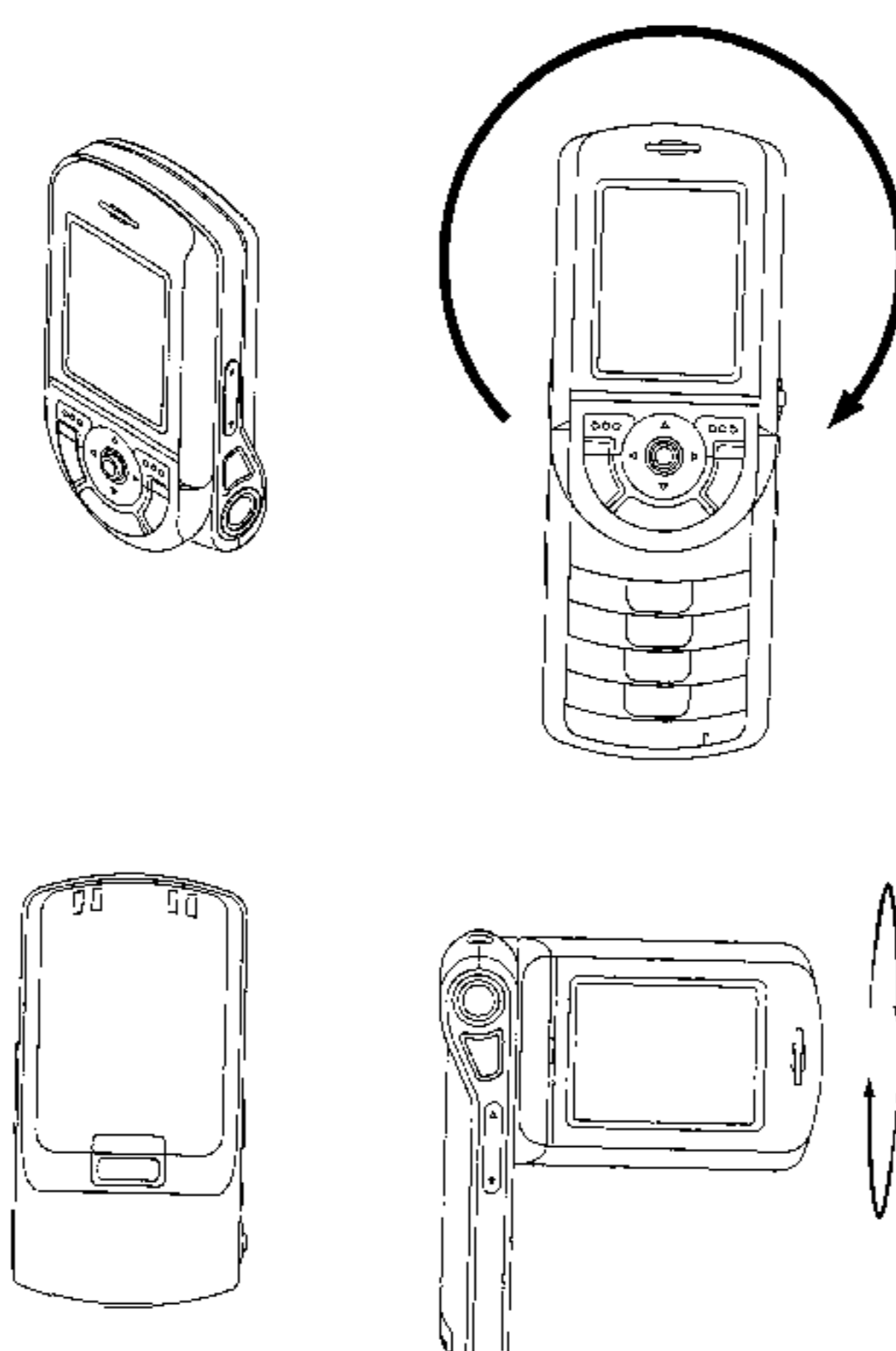

# US D531,973 S

Page 2

---

## U.S. PATENT DOCUMENTS

2004/0198460	A1 *	10/2004	Sakuta et al. ....	455/566	2005/0124397	A1 *	6/2005	Yamasaki .....	455/575.4
2004/0203535	A1 *	10/2004	Kim et al. ....	455/90.3	2005/0130718	A1 *	6/2005	Woo .....	455/575.3
2004/0224730	A1 *	11/2004	Sakai et al. ....	455/575.3	2005/0202856	A1 *	9/2005	Park et al. ....	455/575.1
2004/0248628	A1 *	12/2004	Taninai .....	455/575.3	2005/0215298	A1 *	9/2005	Lee .....	455/575.4
2004/0266477	A1 *	12/2004	Murata .....	455/556.1	2005/0250532	A1 *	11/2005	Hwang et al. ....	455/550.1
2005/0107126	A1 *	5/2005	Kim .....	455/565	2006/0019726	A1 *	1/2006	Park et al. ....	455/575.1
2005/0124394	A1 *	6/2005	Kim et al. ....	455/575.3					

\* cited by examiner

**FIG. 1**

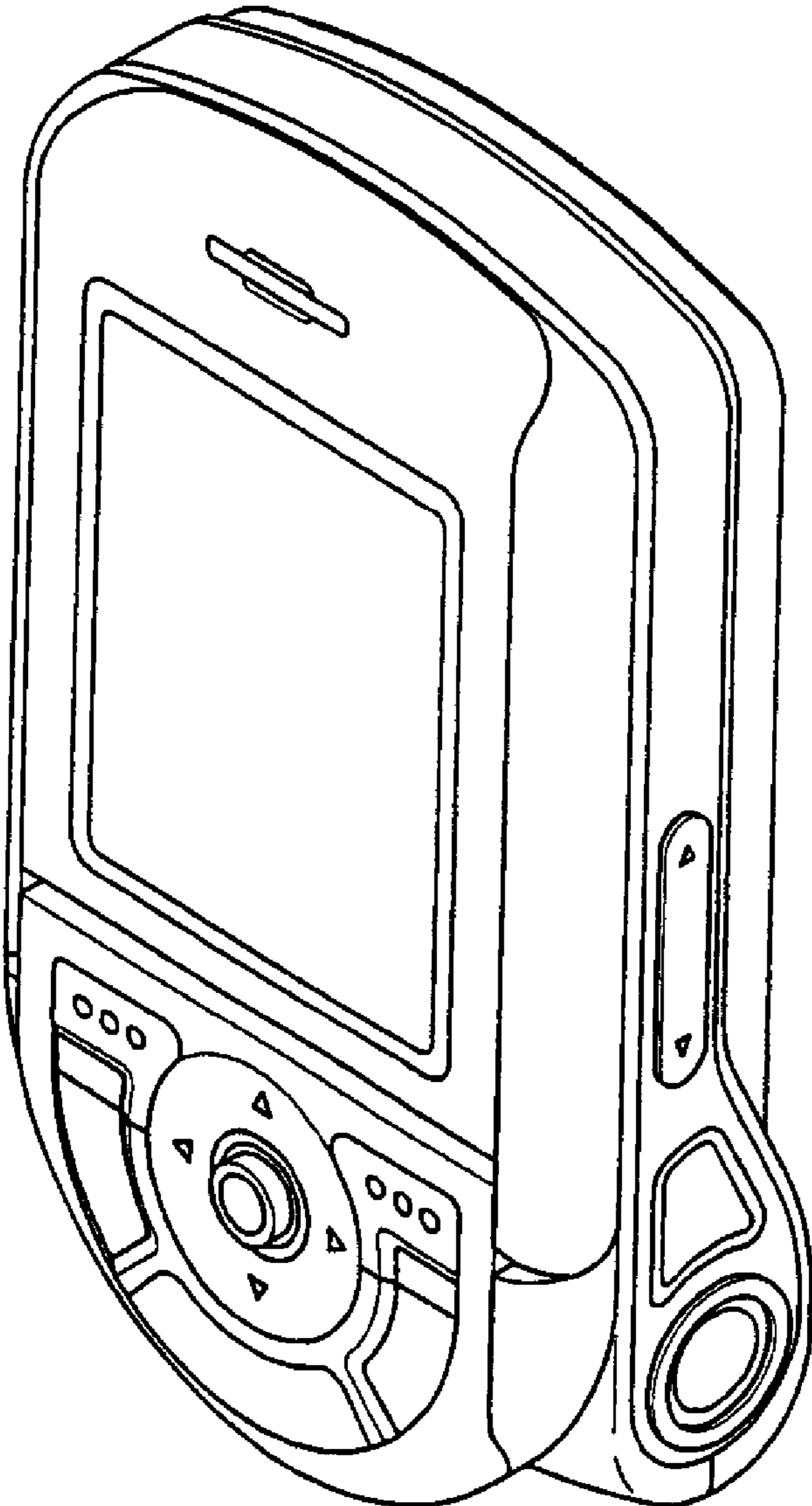

FIG. 2

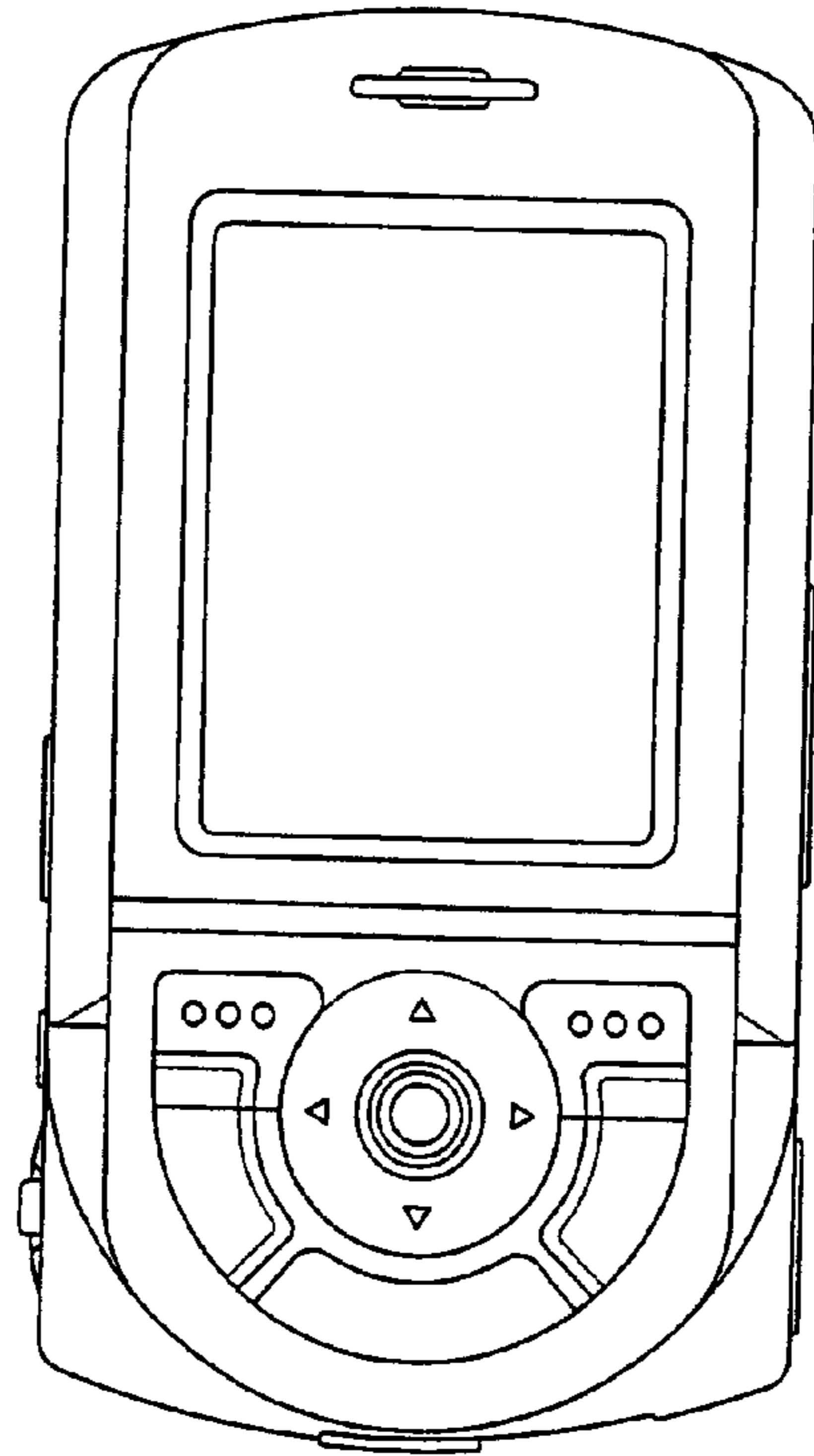
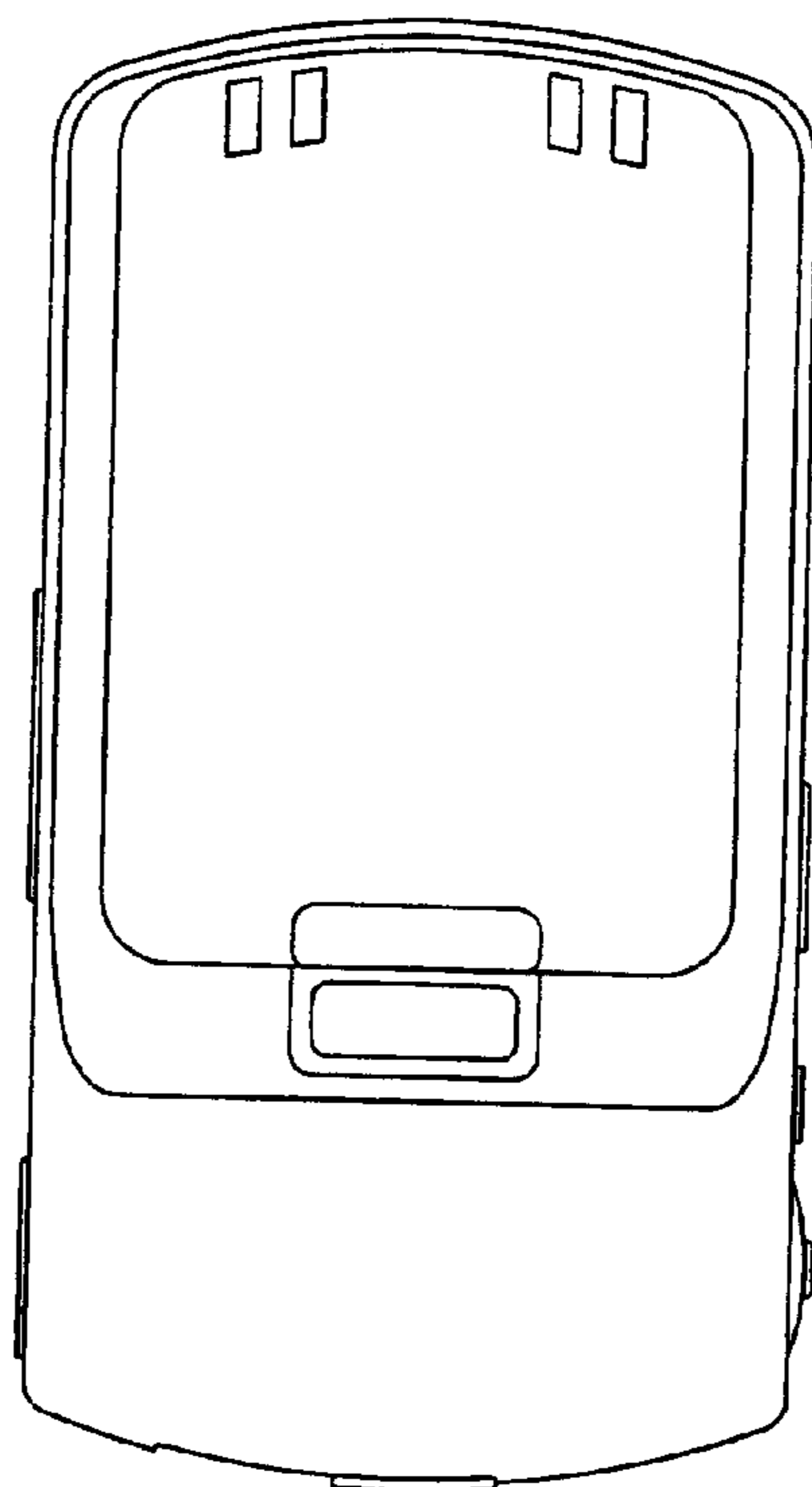
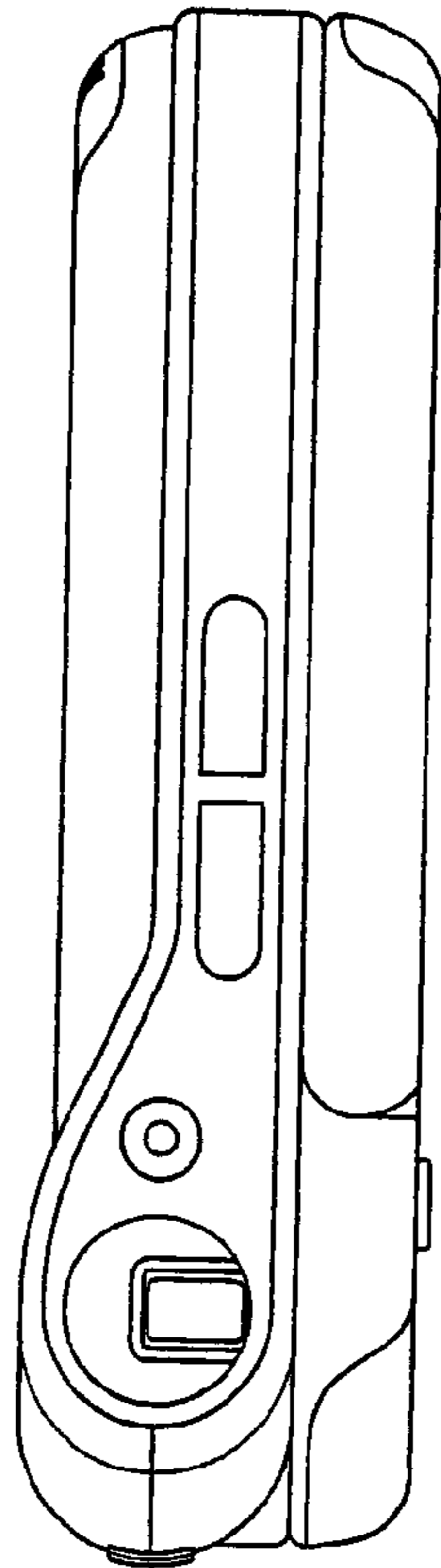
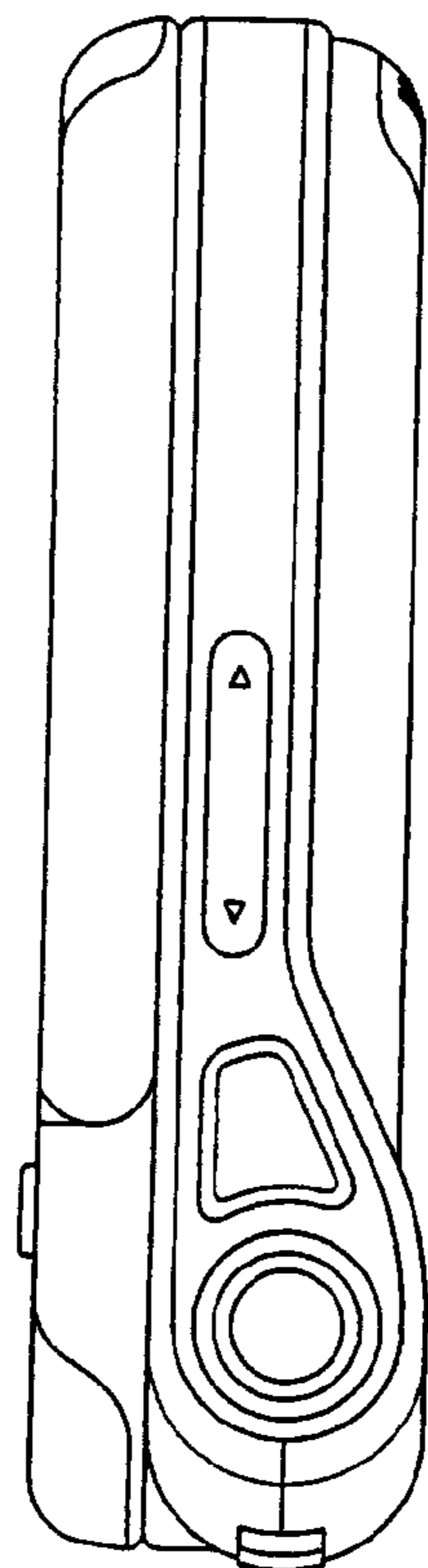

FIG. 3



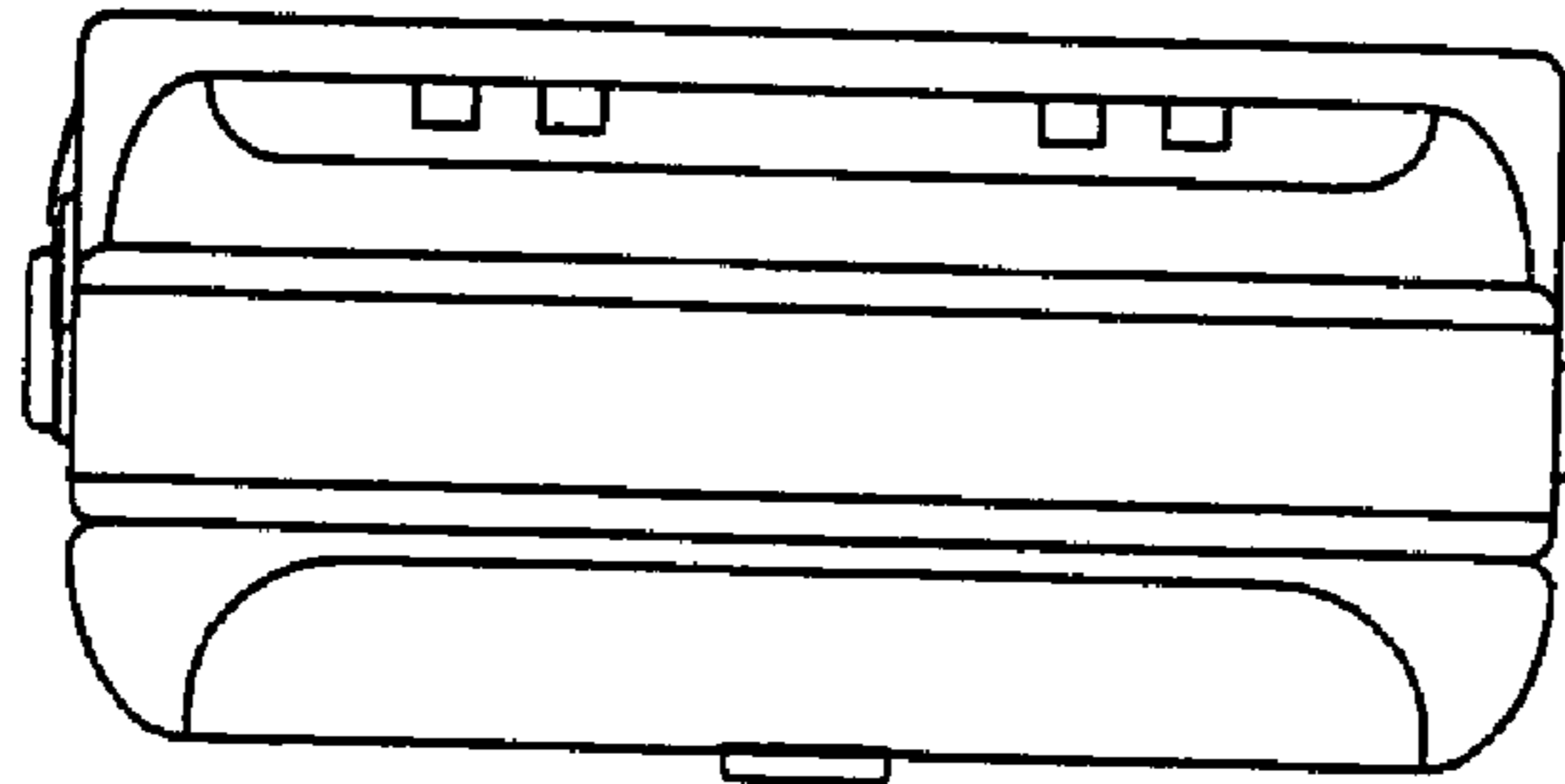

**FIG. 4**



**FIG. 5**

**FIG. 6**



**FIG. 7**

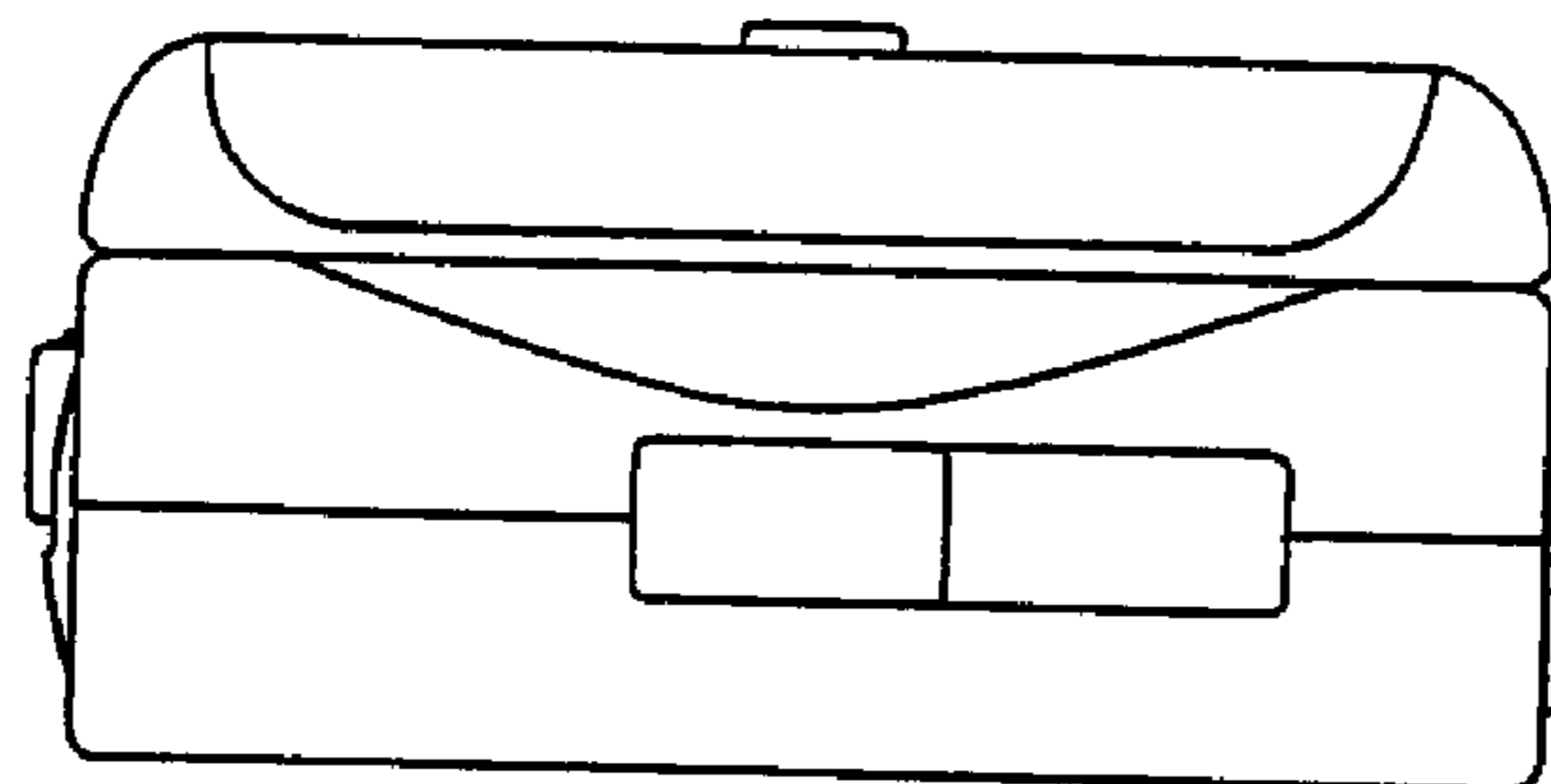

FIG. 8

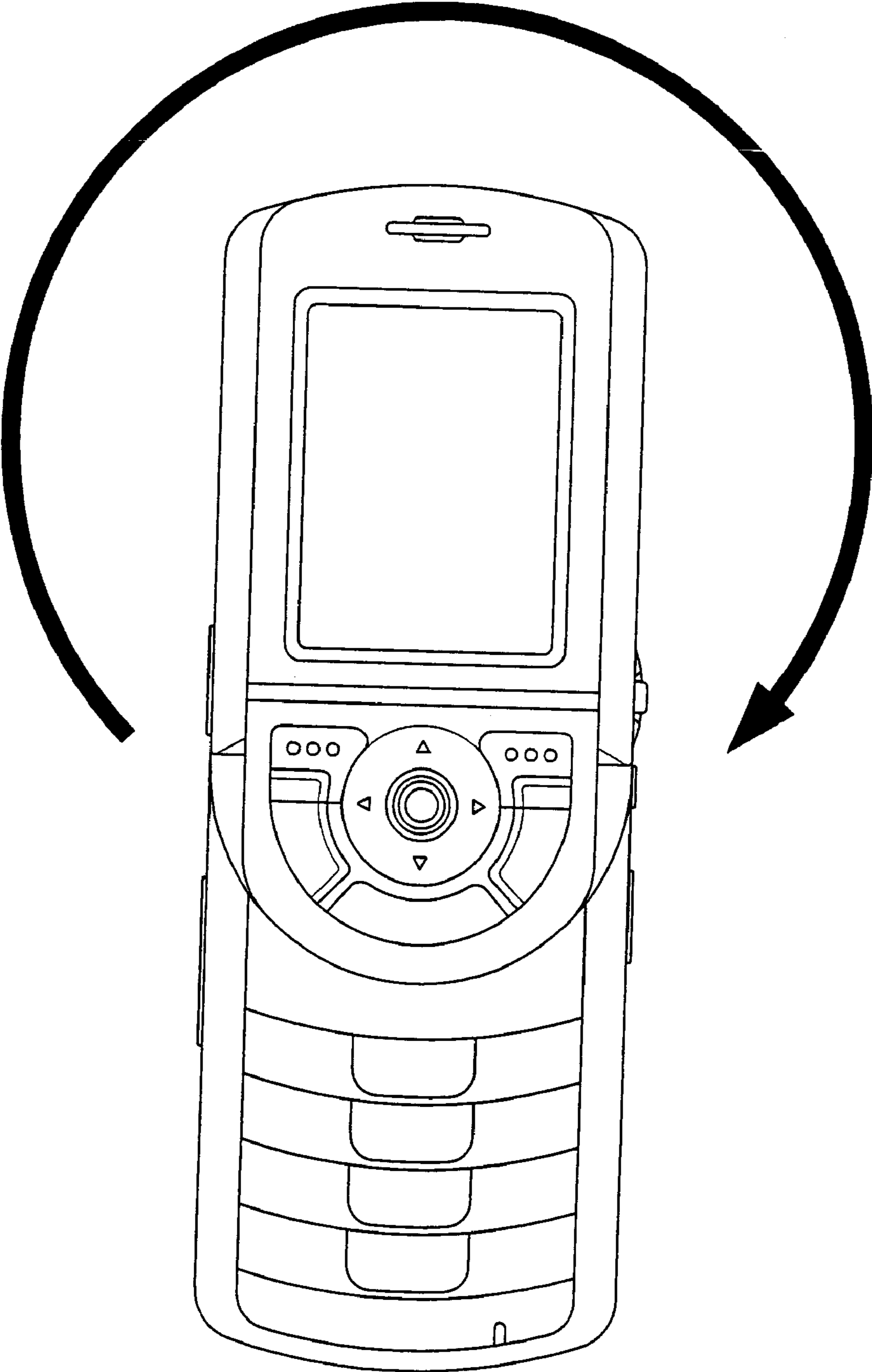

FIG. 9

