



US00D531956S

(12) **United States Design Patent**
Krieger et al.

(10) **Patent No.:** **US D531,956 S**

(45) **Date of Patent:** **** Nov. 14, 2006**

(54) **MARINE BATTERY CHARGER**

(75) Inventors: **Michael Krieger**, Miami Beach, FL (US); **Kevin Ellsworth**, Alva, FL (US)

(73) Assignee: **Vector Products, Inc.**, Fort Lauderdale, FL (US)

(**) Term: **14 Years**

(21) Appl. No.: **29/241,680**

(22) Filed: **Nov. 1, 2005**

(51) **LOC (8) Cl.** **13-02**

(52) **U.S. Cl.** **D13/107**

(58) **Field of Classification Search** D13/106–110, D13/118–119, 184; 320/103–105, 107–115
See application file for complete search history.

(56) **References Cited**

U.S. PATENT DOCUMENTS

3,165,689	A	*	1/1965	Hughes	320/104
D311,897	S	*	11/1990	Moore et al.	D13/107
D401,216	S	*	11/1998	Person et al.	D13/110
D453,139	S	*	1/2002	Yang	D13/110
D454,343	S	*	3/2002	Hicks	D14/253
D483,326	S	*	12/2003	Krieger et al.	D13/107
D486,446	S	*	2/2004	Hriscu et al.	D13/110
D491,139	S	*	6/2004	Krieger et al.	D13/107
D491,140	S	*	6/2004	Krieger et al.	D13/107
D491,523	S	*	6/2004	Chi et al.	D13/110

D518,435	S	*	4/2006	Kurth	D13/107
D518,769	S	*	4/2006	Kurth	D13/107
2001/0043052	A1	*	11/2001	Griffey et al.	320/114

* cited by examiner

Primary Examiner—Alan P. Douglas

Assistant Examiner—Rosemary K. Tarcza

(74) *Attorney, Agent, or Firm*—Venable LLP; Robert Kinberg; Manni Li

(57) **CLAIM**

The ornamental design for a marine battery charger, as shown and described.

DESCRIPTION

FIG. 1 is a perspective view from the front-top-left side of the battery charger showing our new design; FIG. 2 is a front view of the design shown in FIG. 1; FIG. 3 is a rear view of the design shown in FIG. 1; FIG. 4 is a left side view of the design shown in FIG. 1; FIG. 5 is a right side view of the design shown in FIG. 1; FIG. 6 is a top view of the design shown in FIG. 1; FIG. 7 is a bottom view of the design shown in FIG. 1; and, FIG. 8 is a perspective view as shown in FIG. 1 with the top handle being lifted up.

The broken lines immediately adjacent the shaded areas represent the bounds of the claimed design while all other broken lines are for illustrative purposes only; the broken lines form no part of the claimed design.

1 Claim, 6 Drawing Sheets

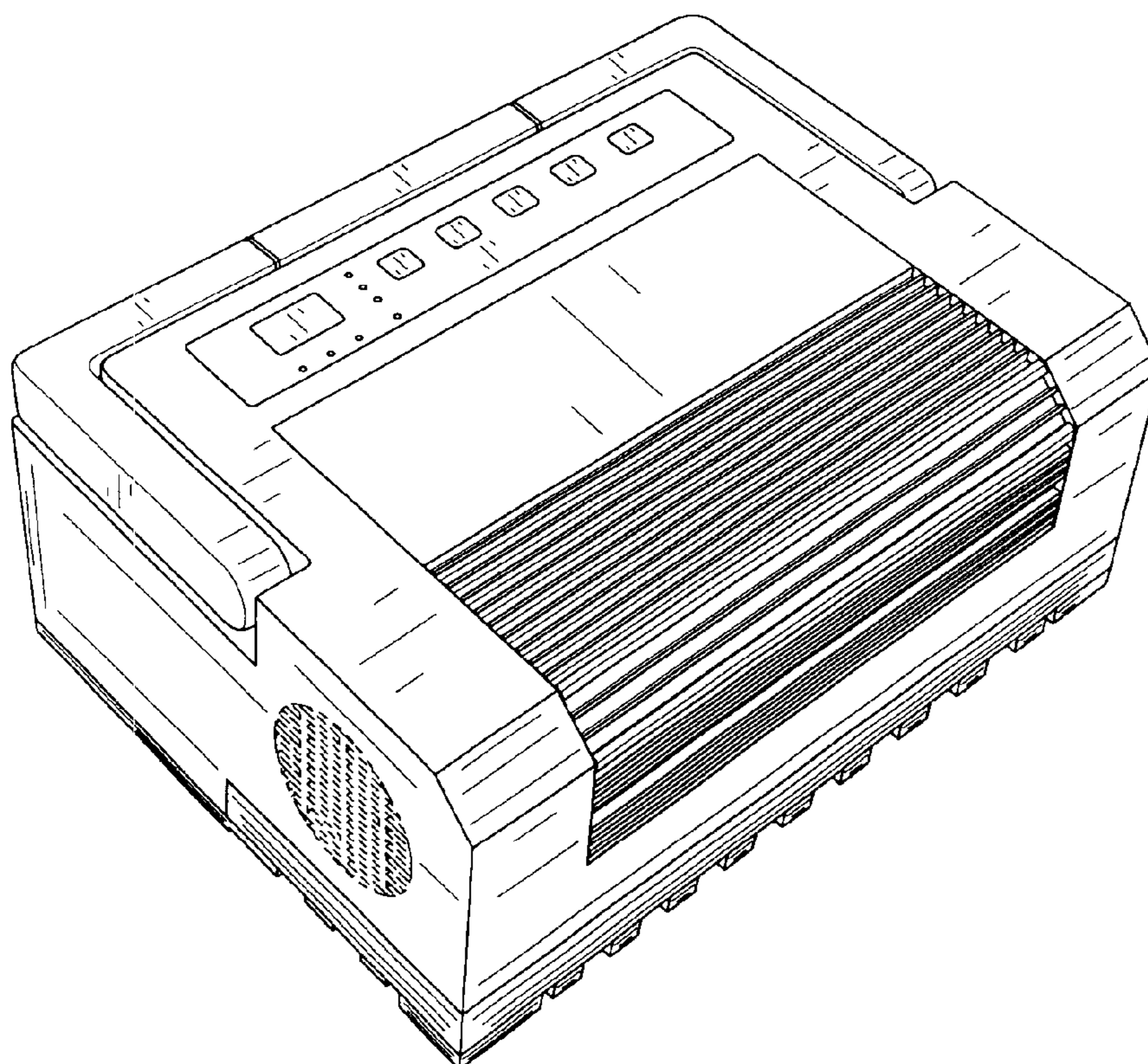

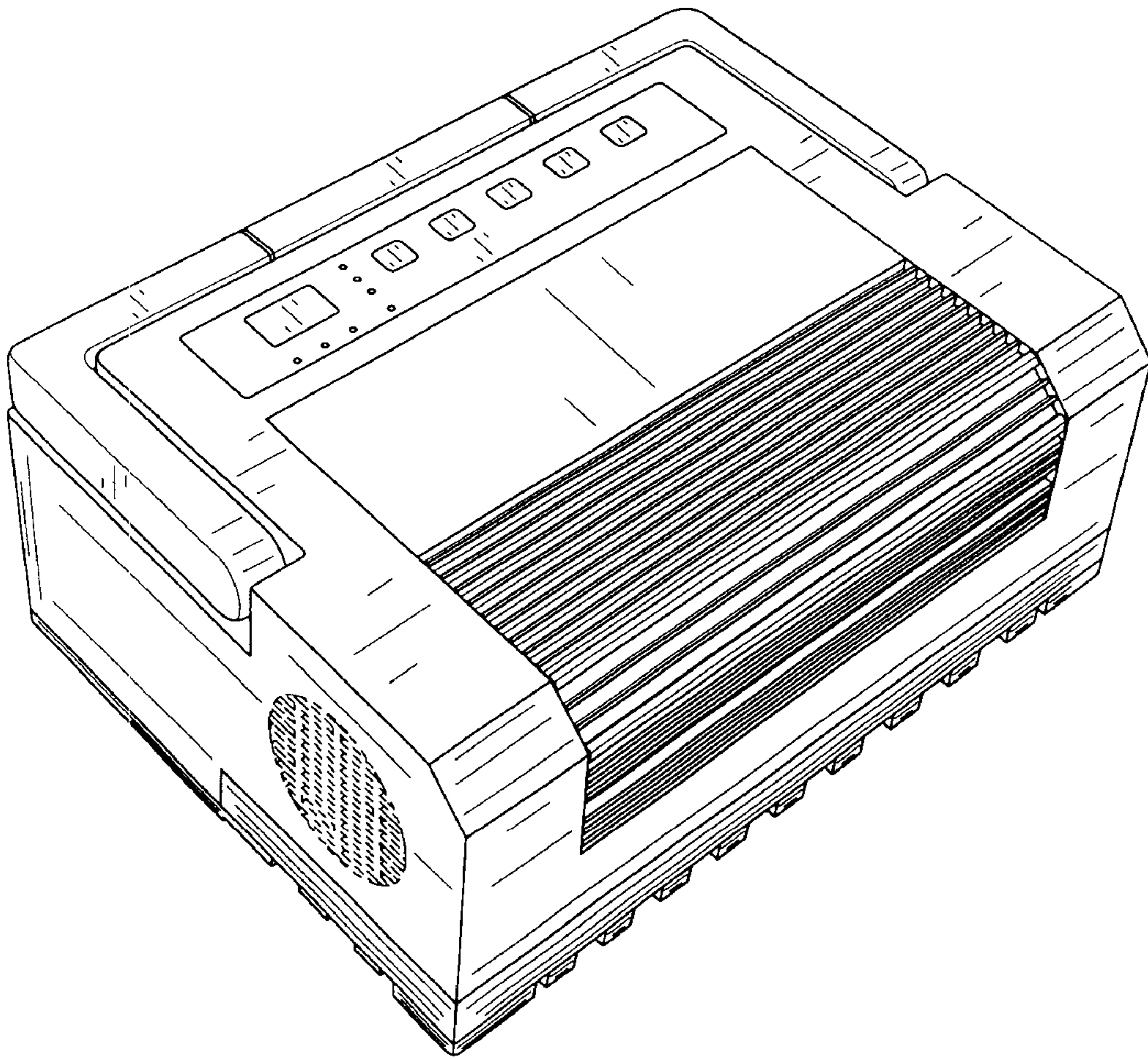

FIG. 1

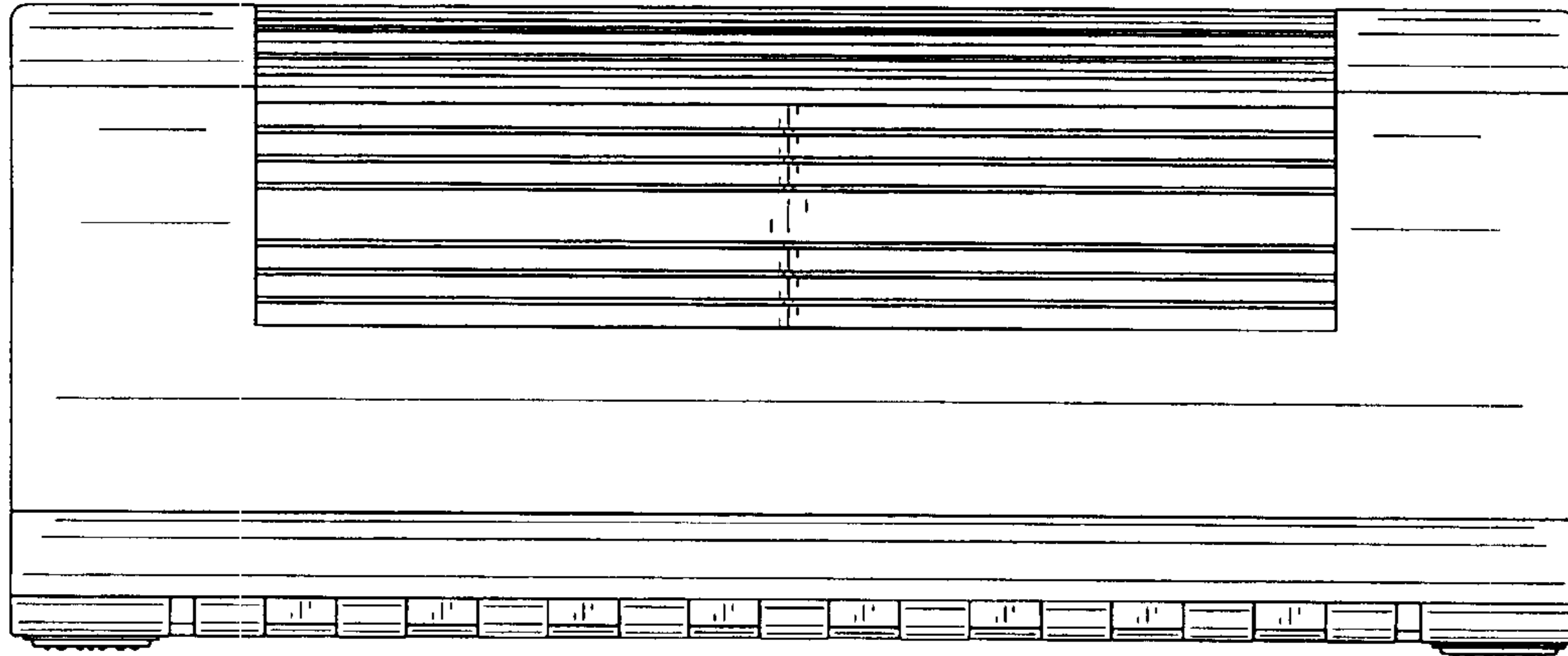

FIG. 2

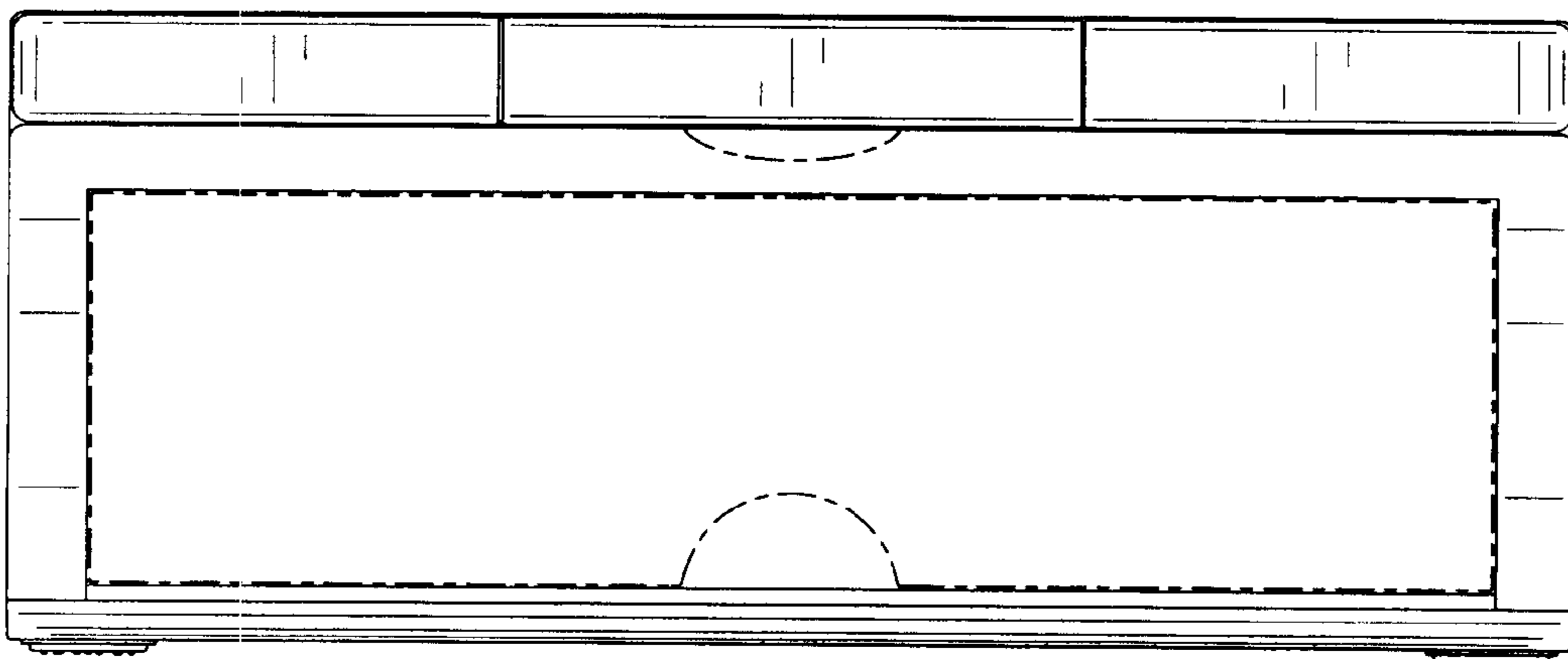

FIG. 3

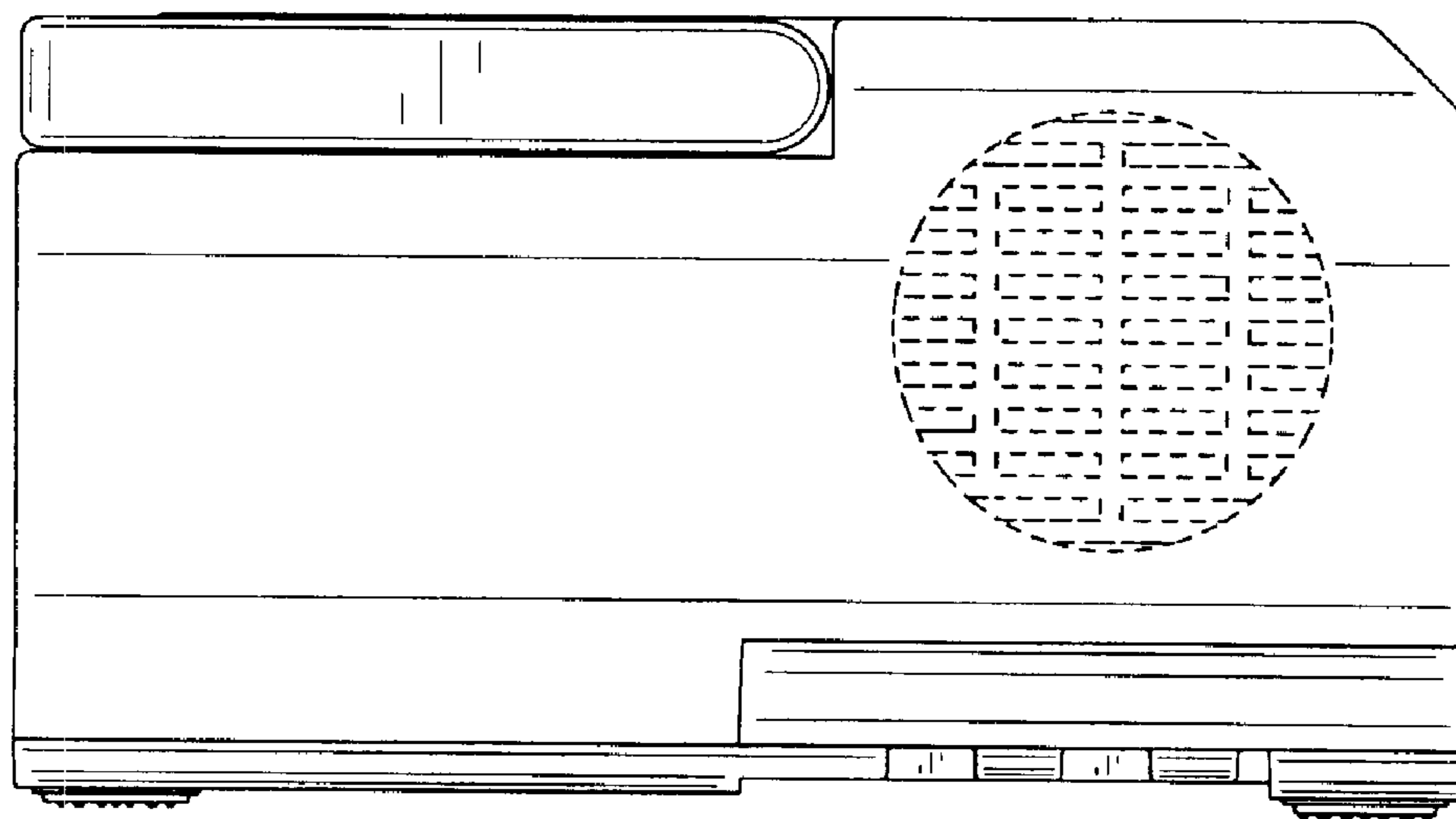

FIG. 4

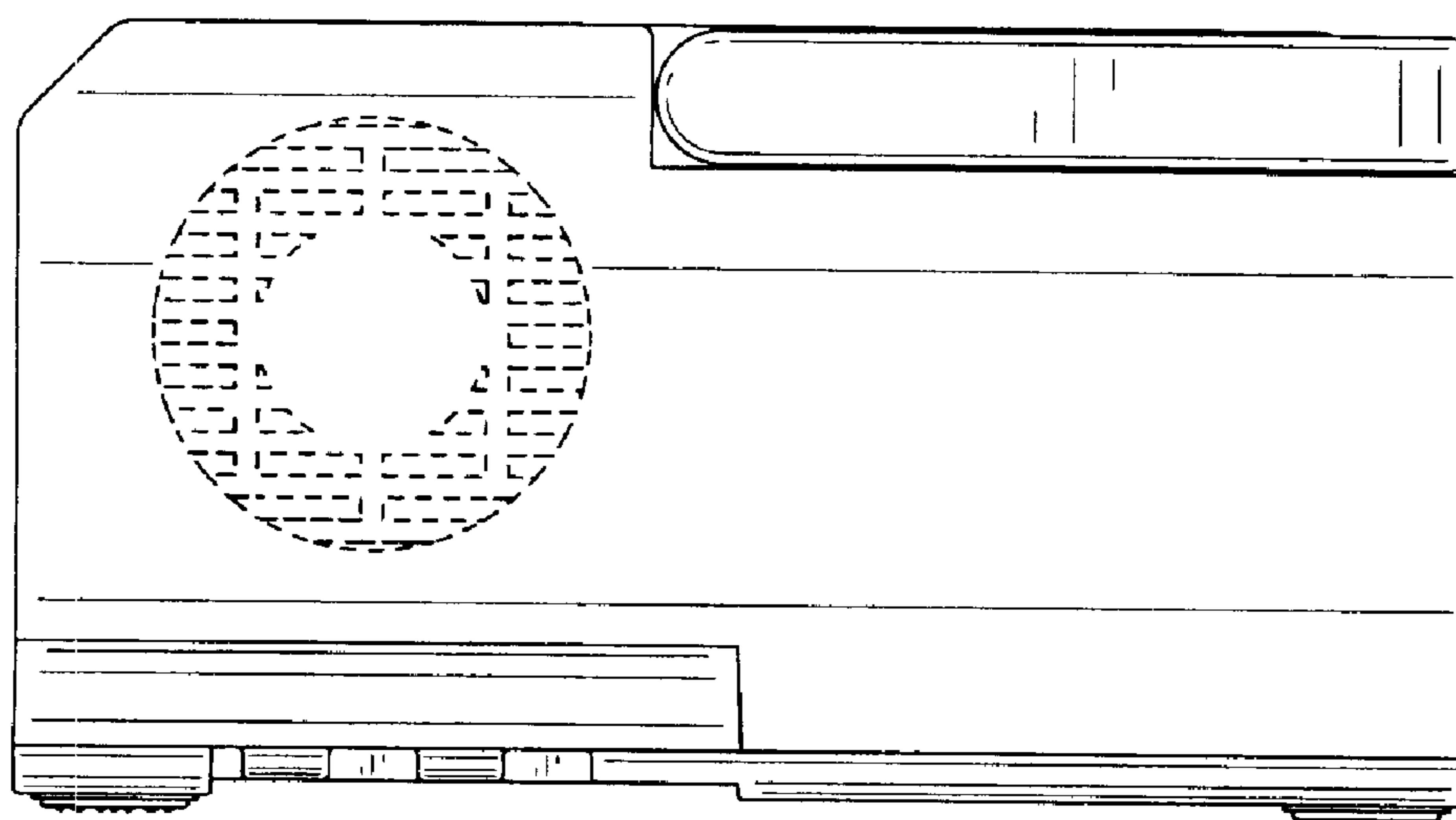

FIG. 5

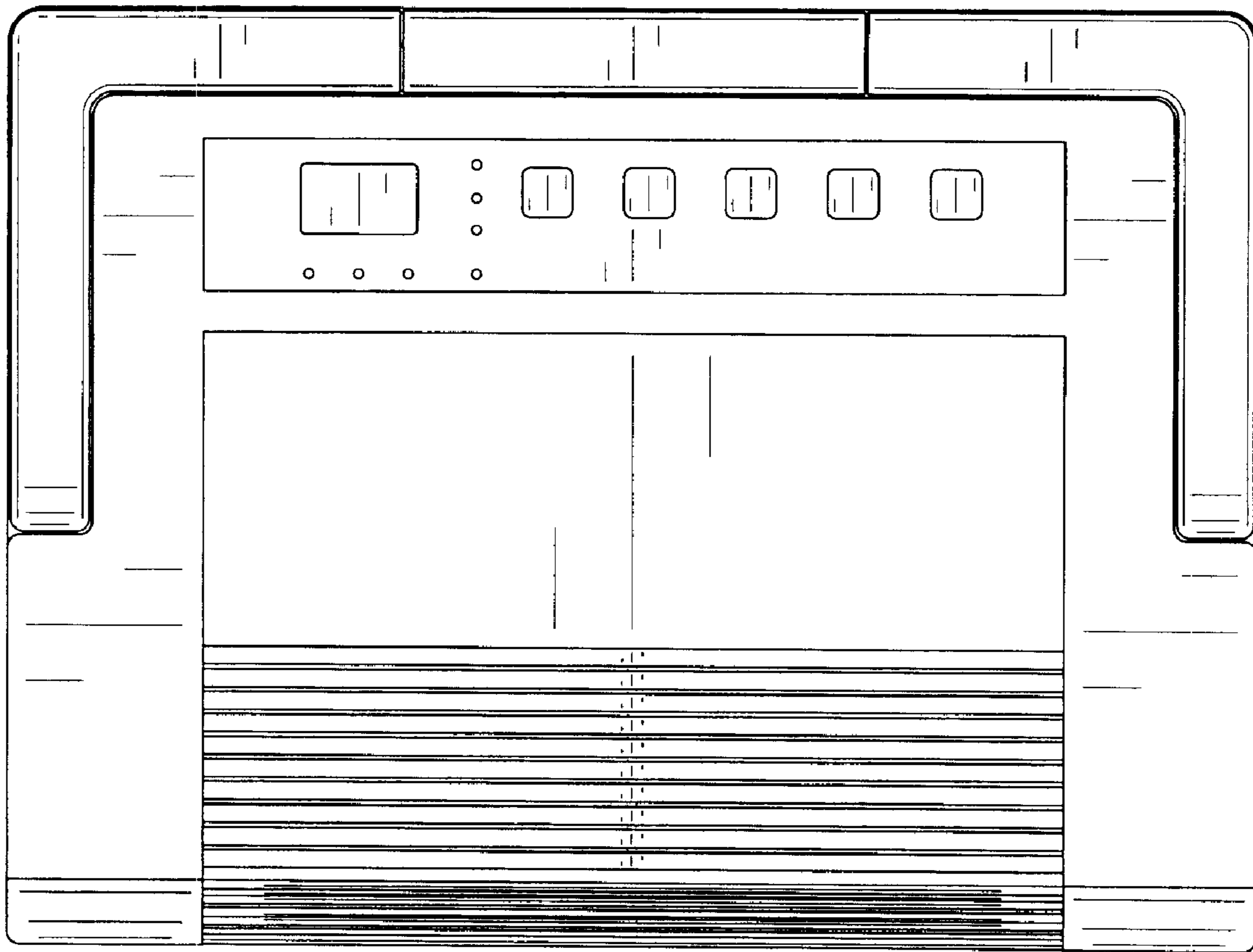

FIG. 6

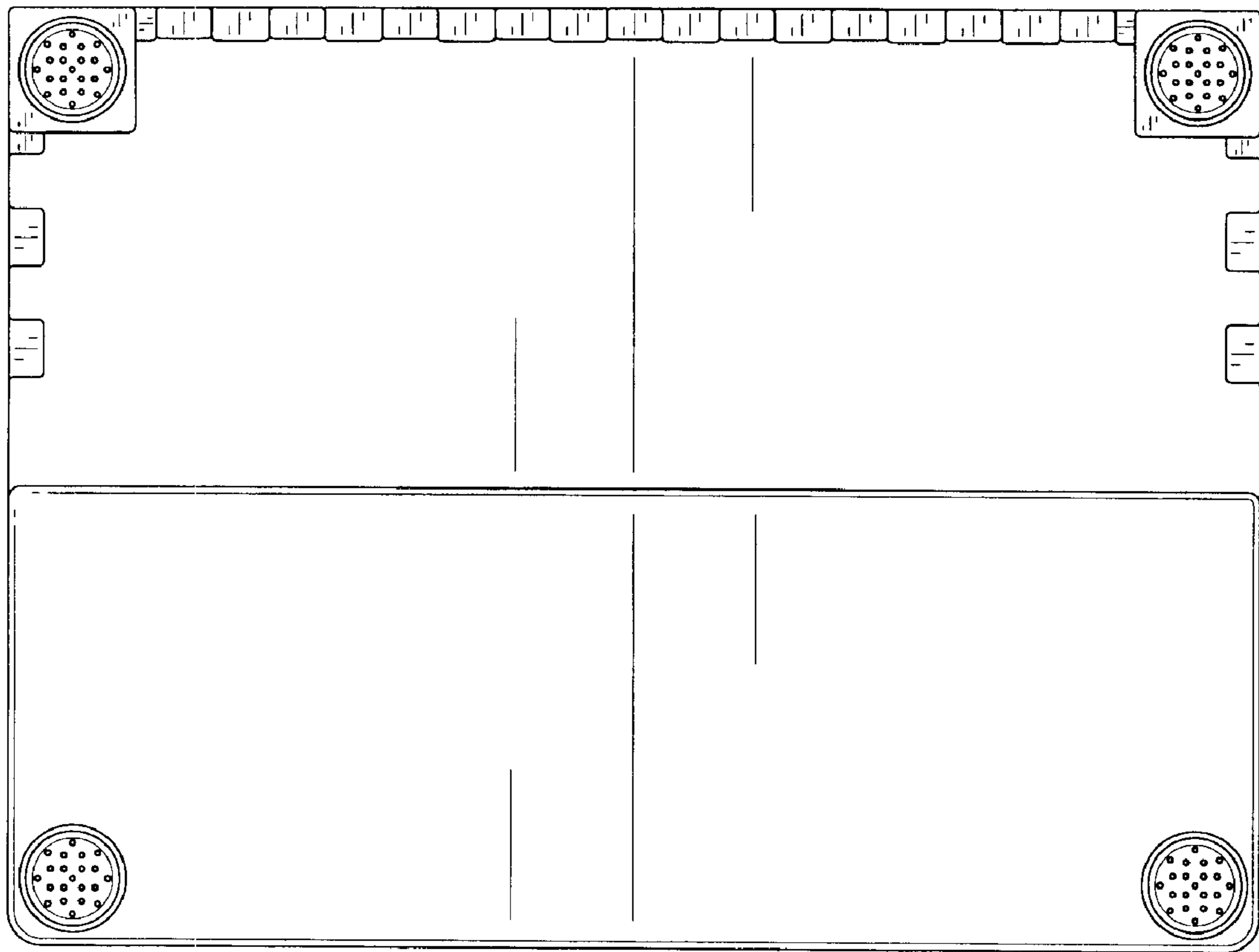

FIG. 7

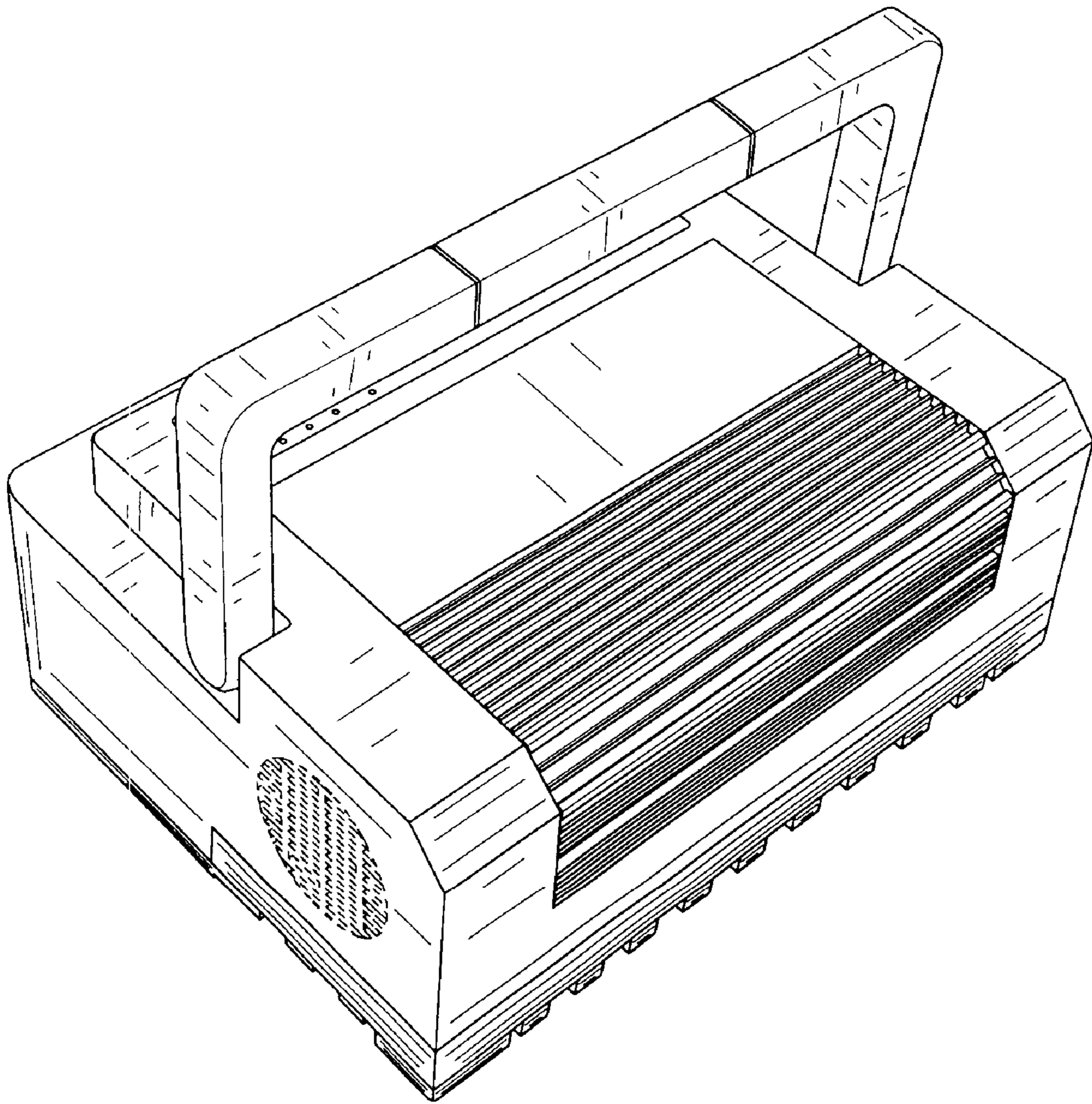

FIG. 8