



US00D531907S

(12) **United States Design Patent**  
**Lepoitevin**

(10) **Patent No.:** **US D531,907 S**

(45) **Date of Patent:** **\*\* Nov. 14, 2006**

(54) **BOTTLE**

(75) **Inventor:** **Laurent Lepoitevin**, Le Havre Cedex (FR)

(73) **Assignee:** **Sidel**, Octeville sur Mer (FR)

(\*\*) **Term:** **14 Years**

(21) **Appl. No.:** **29/244,107**

(22) **Filed:** **Dec. 5, 2005**

(30) **Foreign Application Priority Data**

Jun. 3, 2005 (EM) ..... 000350111

(51) **LOC (8) Cl.** ..... **09-01**

(52) **U.S. Cl.** ..... **D9/531**

(58) **Field of Classification Search** ..... D9/500,  
D9/502, 503, 516, 520, 523, 530-540, 543-545,  
D9/549, 550, 556-559, 561, 563, 570; 215/1 A,  
215/1 L, 40, 43-49, 398; 222/488, 489, 544,  
222/566-568, 570

See application file for complete search history.

(56) **References Cited**

**U.S. PATENT DOCUMENTS**

D70,266 S \* 6/1926 Crosby ..... D9/536

D89,301 S \* 2/1933 Fuerst ..... D9/536  
D100,341 S \* 7/1936 Steinbiss ..... D9/536  
D107,542 S \* 12/1937 Moore et al. .... D9/531  
D162,147 S \* 2/1951 Fuerst ..... D9/536  
D211,000 S \* 5/1968 Pattengill ..... D9/536  
D212,671 S \* 11/1968 Jurgens ..... D9/536  
D213,948 S \* 4/1969 Anderson ..... D9/536

\* cited by examiner

*Primary Examiner*—Nanda Bondade

*Assistant Examiner*—Shanda C. Hill

(74) *Attorney, Agent, or Firm*—Marshall, Gerstein & Borun LLP

(57) **CLAIM**

The ornamental design for a bottle, as shown and described.

**DESCRIPTION**

FIG. 1 is a top perspective view of a bottle showing my new design;

FIG. 2 is a bottom perspective view thereof;

FIG. 3 is a side view thereof;

FIG. 4 is a front view thereof; and

FIG. 5 is an opposite side view of FIG. 3

FIG. 6 is a bottom view thereof; and,

FIG. 7 is a top view thereof.

**1 Claim, 2 Drawing Sheets**

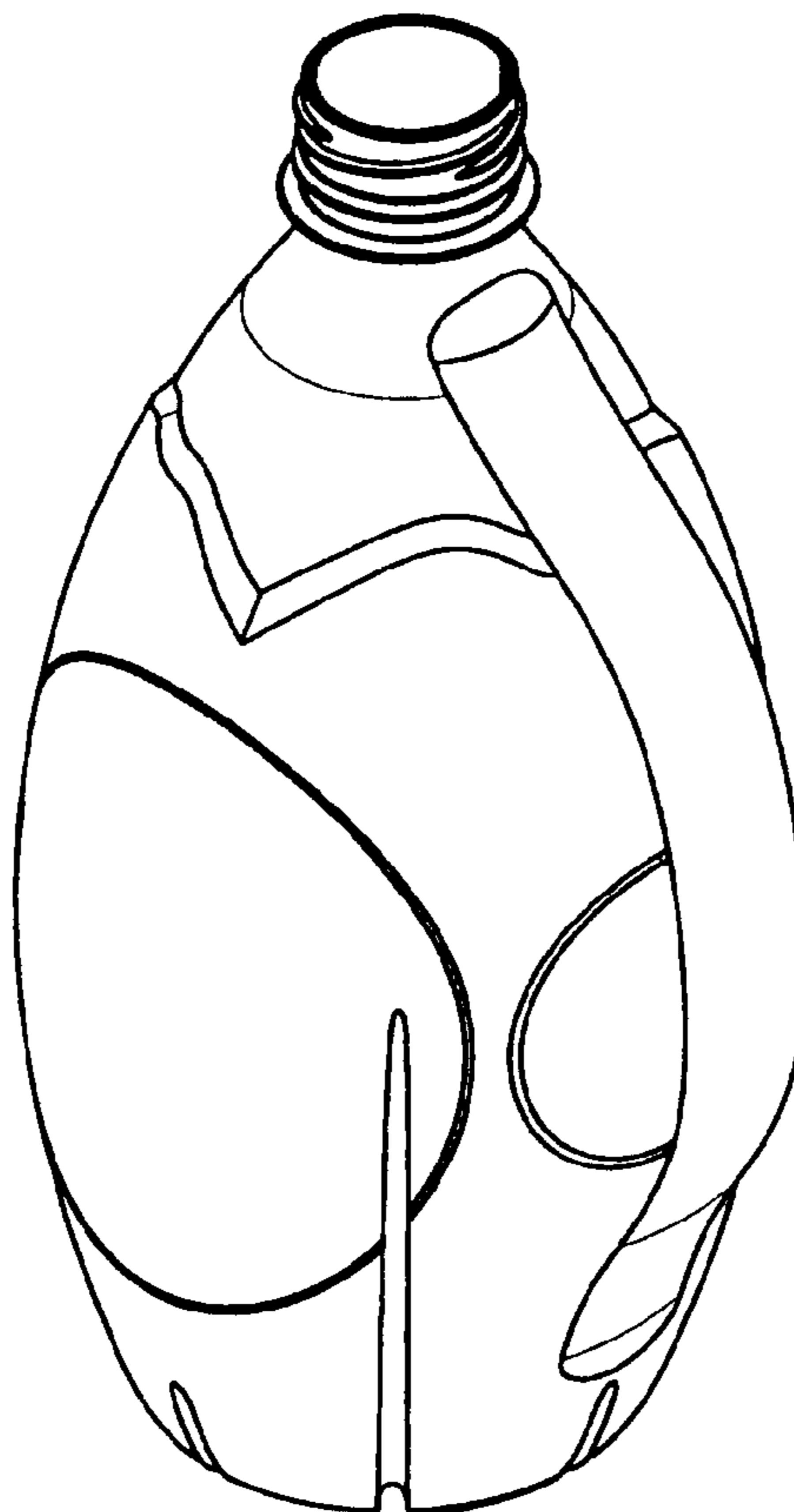

**FIG. 1**

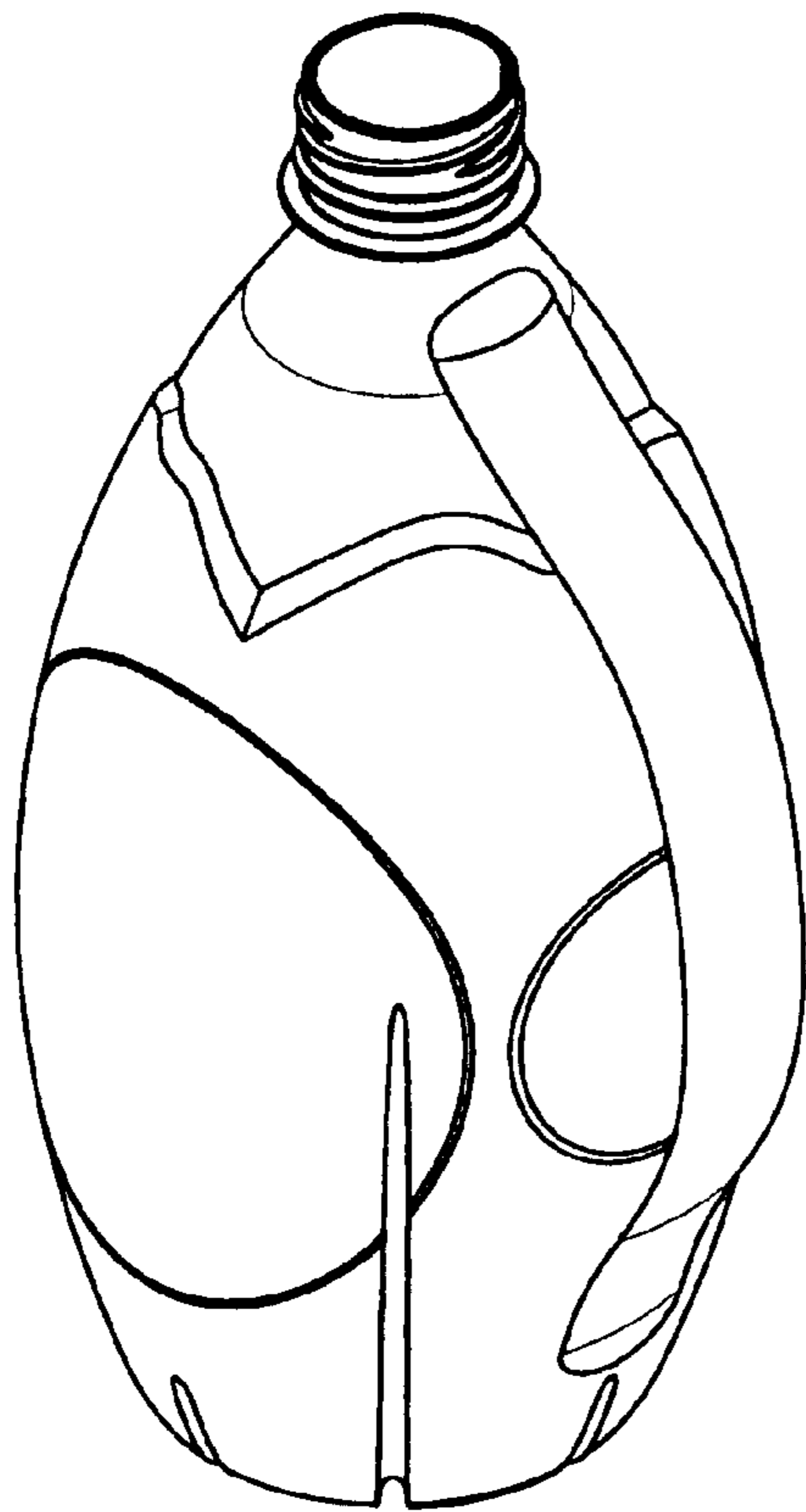

**FIG. 2**

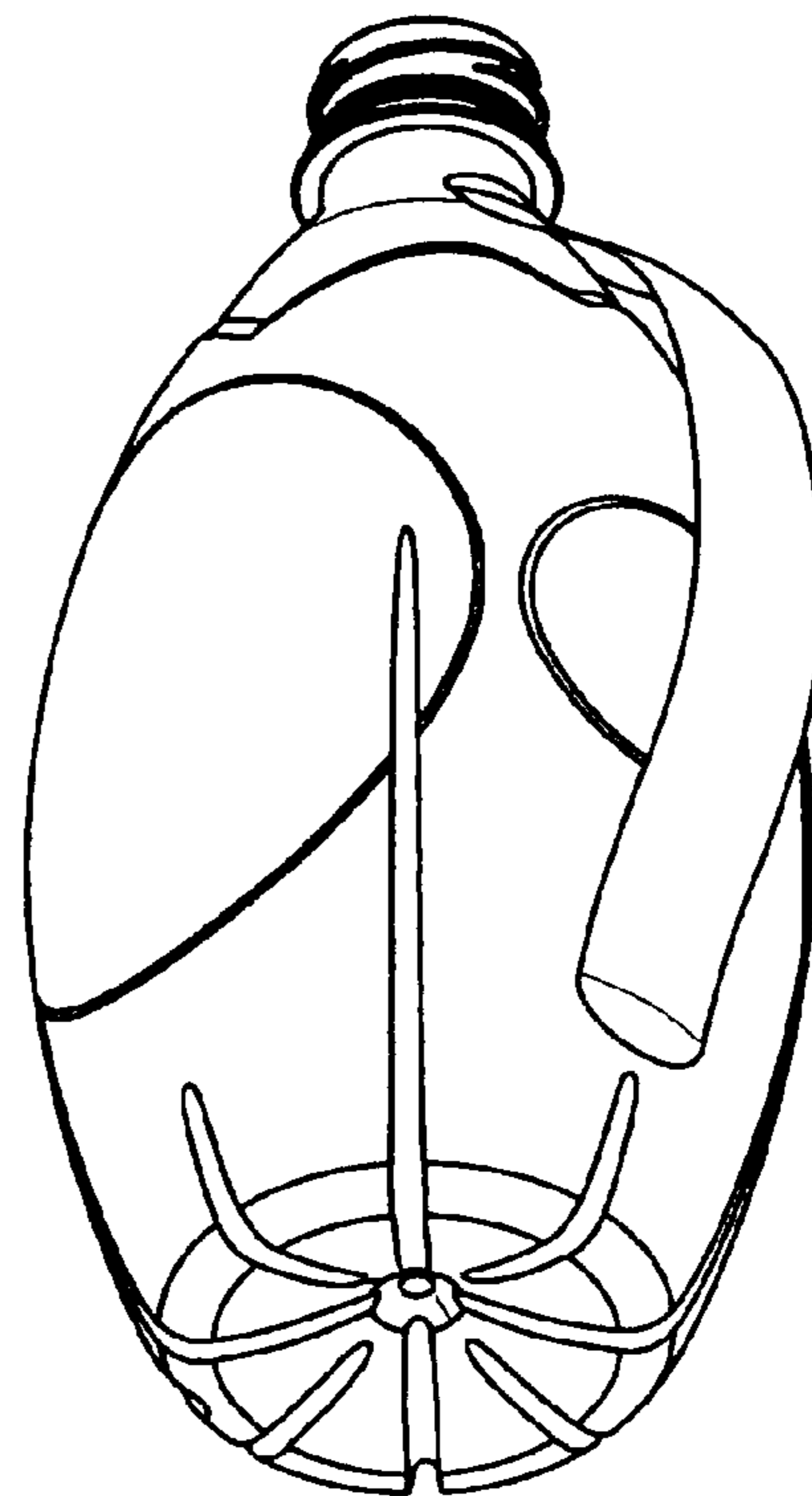

**FIG. 3**

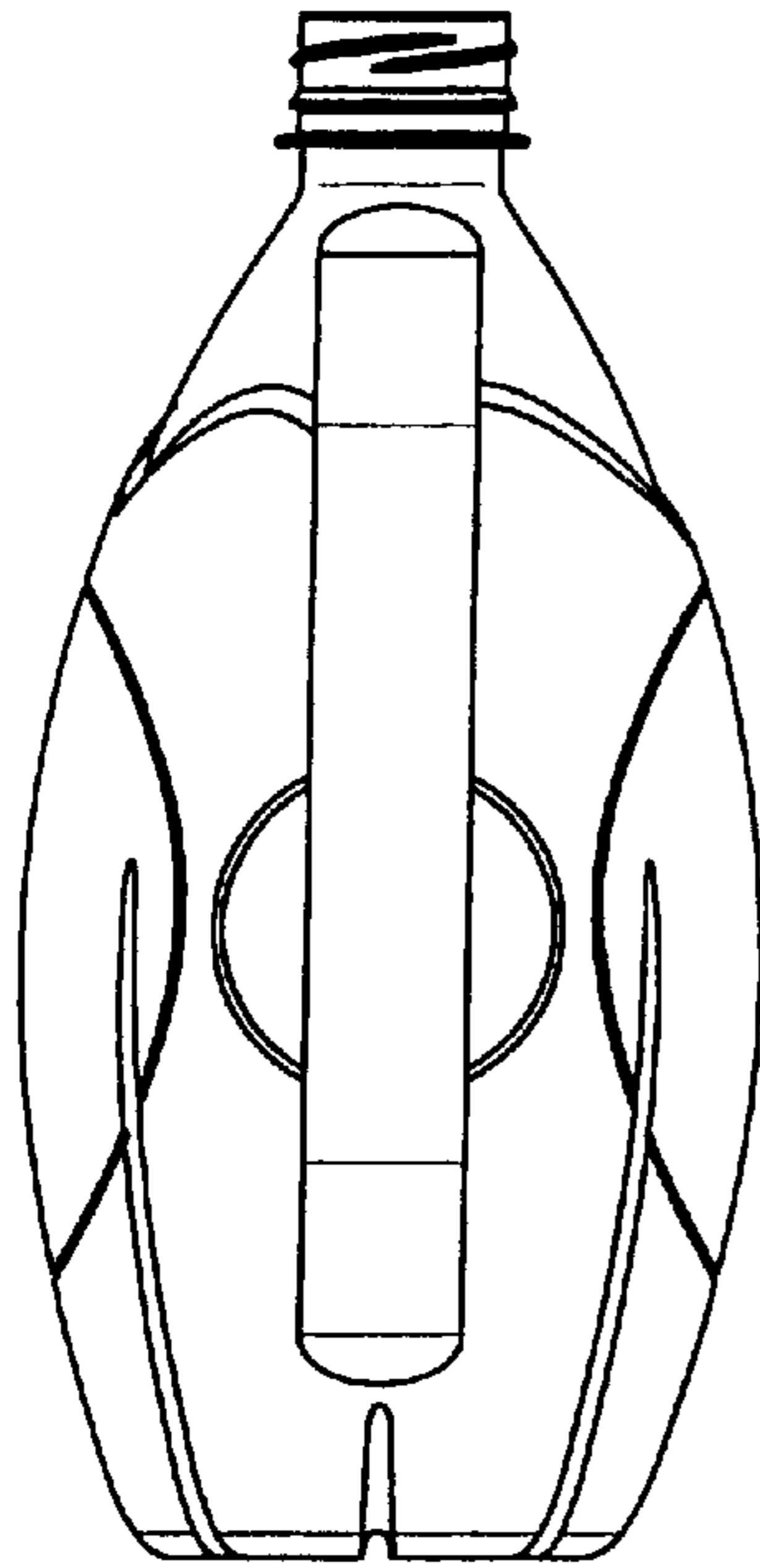

**FIG. 4**

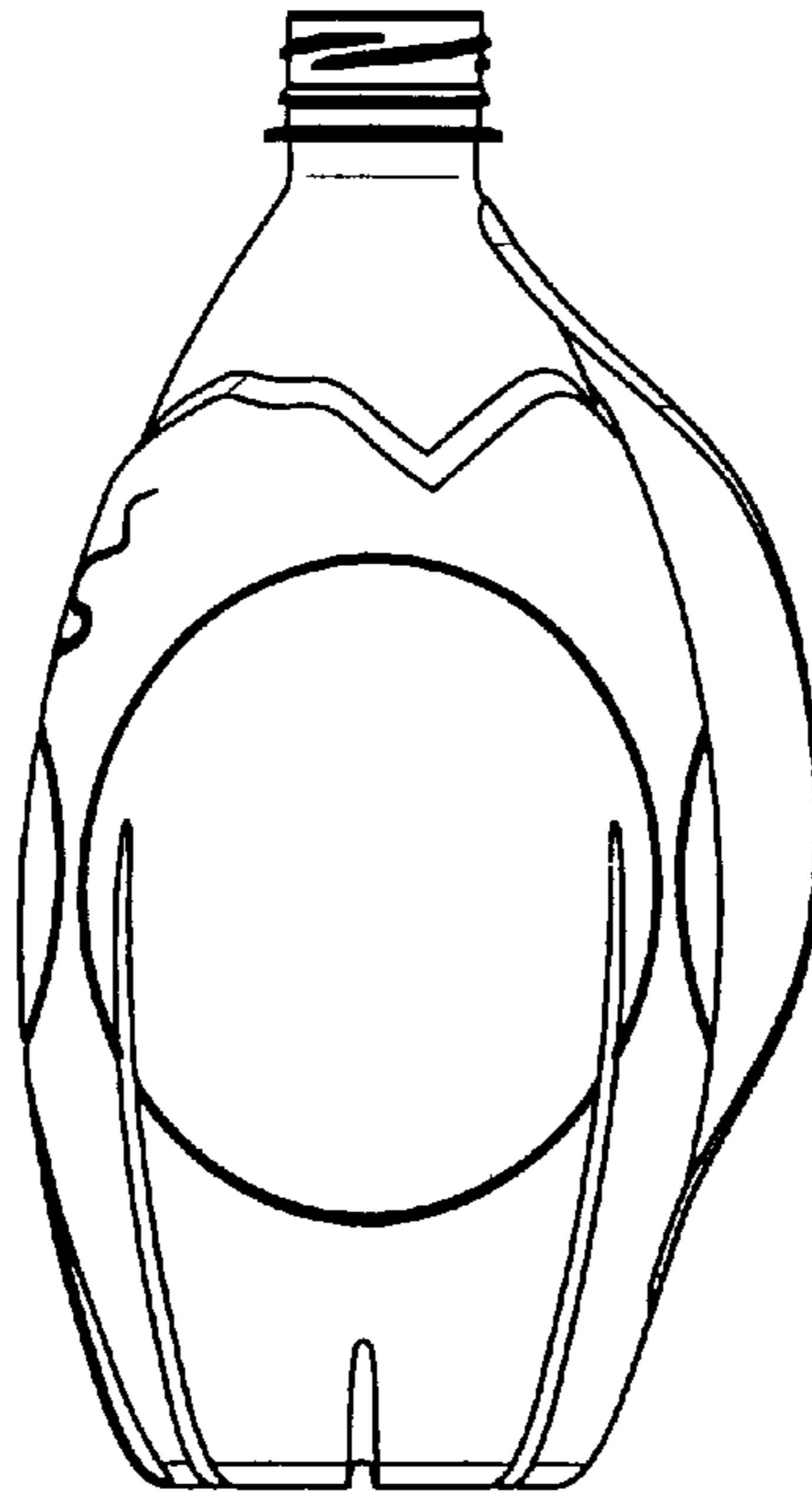

**FIG. 5**

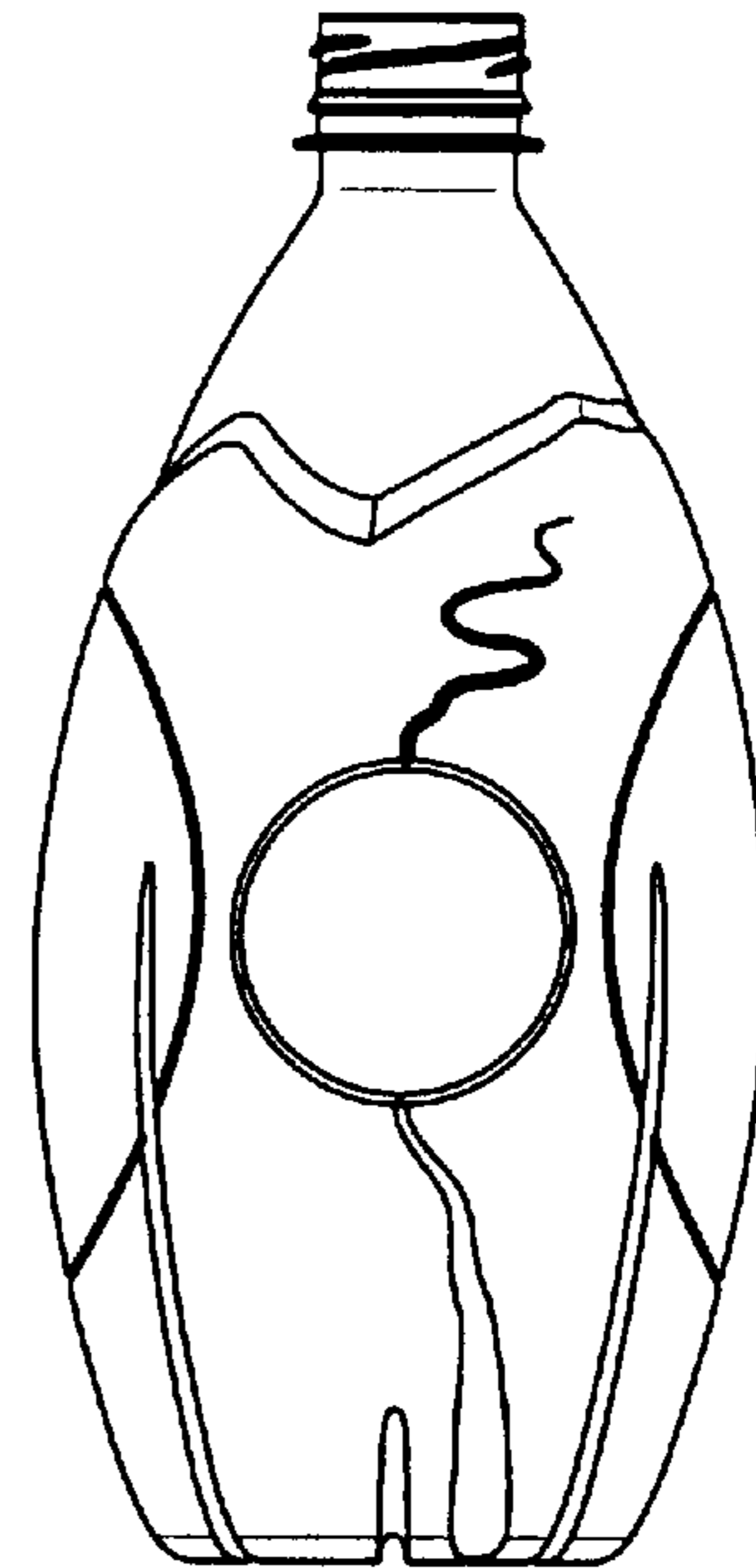

**FIG. 6**

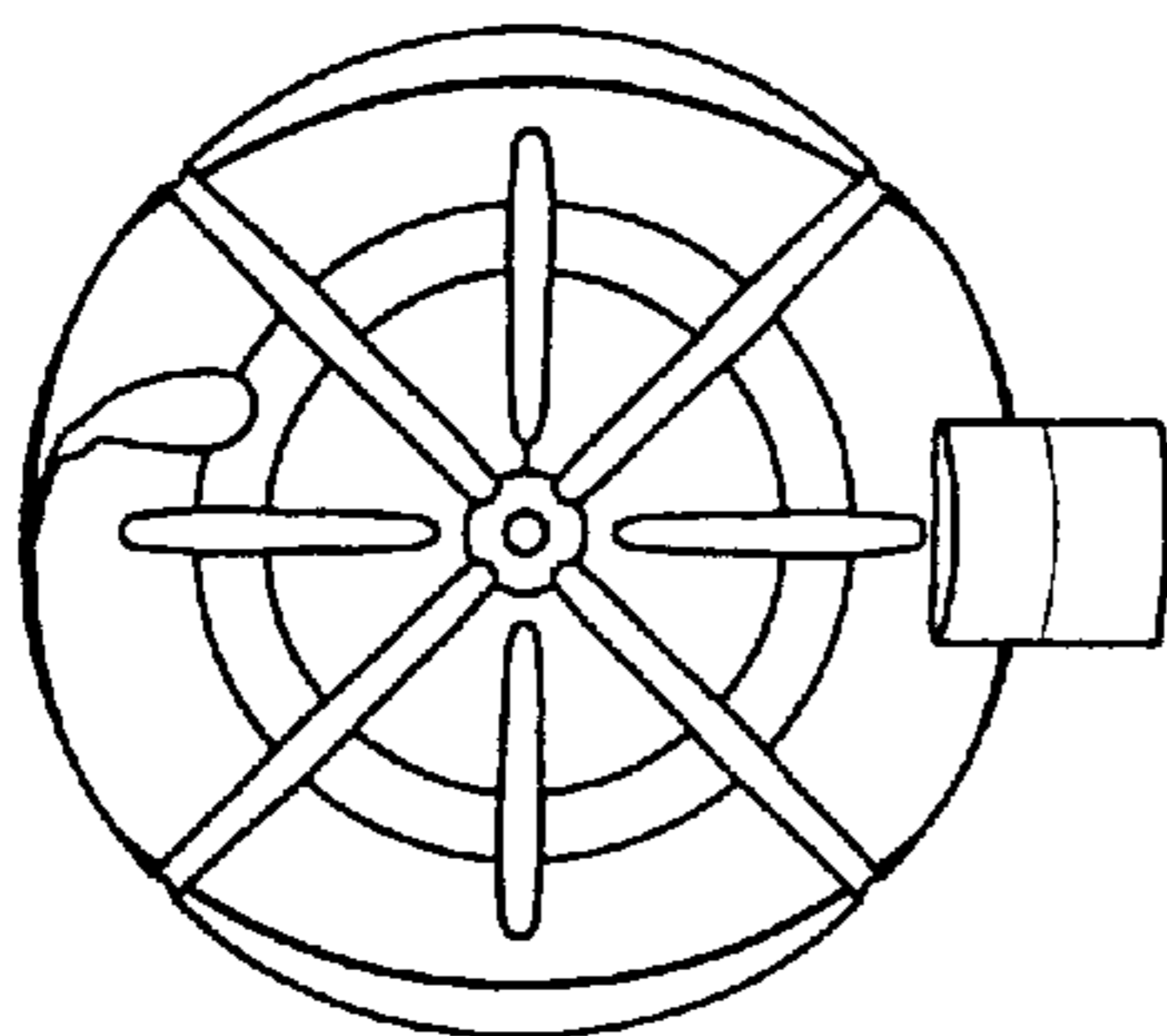

**FIG. 7**

