

US00D531804S

(12) **United States Design Patent**
Pederson et al.

(10) **Patent No.:** **US D531,804 S**

(45) **Date of Patent:** **** Nov. 14, 2006**

(54) **PAINTER'S TOOL CADDY**

D501,285 S * 1/2005 Long, Jr. D34/19

(76) Inventors: **Robert R. Pederson**, 191 Wild Ave.,
Staten Island, NY (US) 10314; **James**
C. Cicconi, Sr., 79 Bentley St., Staten
Island, NY (US) 10307

* cited by examiner

Primary Examiner—Louis S. Zarfes

Assistant Examiner—Kathleen Sims

(74) *Attorney, Agent, or Firm*—Mary A. Whiting, Esq.

(**) Term: **14 Years**

(57) **CLAIM**

(21) Appl. No.: **29/225,397**

We claim, the ornamental design for a painter's tool caddy,
as shown and described.

(22) Filed: **Mar. 15, 2005**

DESCRIPTION

(51) **LOC (8) Cl.** **03-01**

(52) **U.S. Cl.** **D3/315**

(58) **Field of Classification Search** 280/47.34;
D3/201, 273, 283, 302, 315, 905, 274, 282,
D3/304, 307, 310, 313; D6/438, 439; 312/902;
206/373; D34/19, 20, 21

See application file for complete search history.

FIG. 1 is a front isometric view of the painter's tool caddy showing our new design with a drawer and a tray in exploded view, with cover and pair of doors in open position, storage space with pegboard, sleeves, and pair of front legs and back wheels;

FIG. 2 is a rear elevational view showing cover and handle in closed position, thereof;

FIG. 3 is a side view, showing cover and doors in open position, and handle in open position thereof;

FIG. 4 is an opposite side view, showing doors in open position, and handle in open position thereof;

FIG. 5 is a bottom plan view, showing cover in open position, doors in closed position, and handle in closed position, thereof; and,

FIG. 6 is a front isometric view, showing cover in open position, and doors and drawer in closed position, thereof.

(56) **References Cited**

U.S. PATENT DOCUMENTS

- 4,976,450 A * 12/1990 Ellefson 280/79.11
- D381,166 S * 7/1997 Bonazza D34/20
- D411,678 S * 6/1999 Di Paolo D34/21
- D423,817 S * 5/2000 Holcomb et al. D6/445
- 6,164,212 A * 12/2000 Haggard 108/25
- 6,170,839 B1 * 1/2001 Kizewski 280/47.26
- D470,687 S * 2/2003 Binse et al. D6/436
- D489,858 S * 5/2004 Hay et al. D34/20

1 Claim, 4 Drawing Sheets

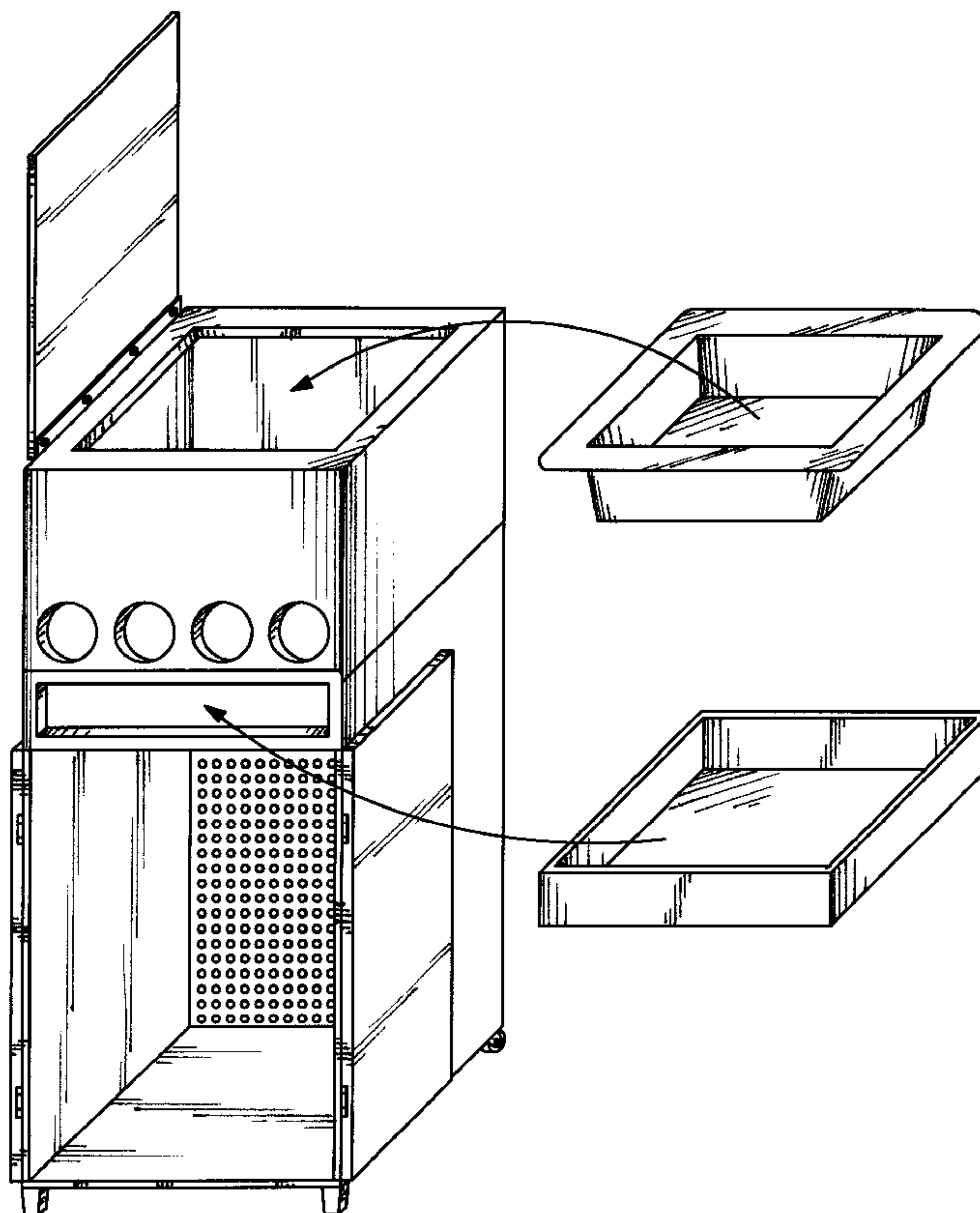

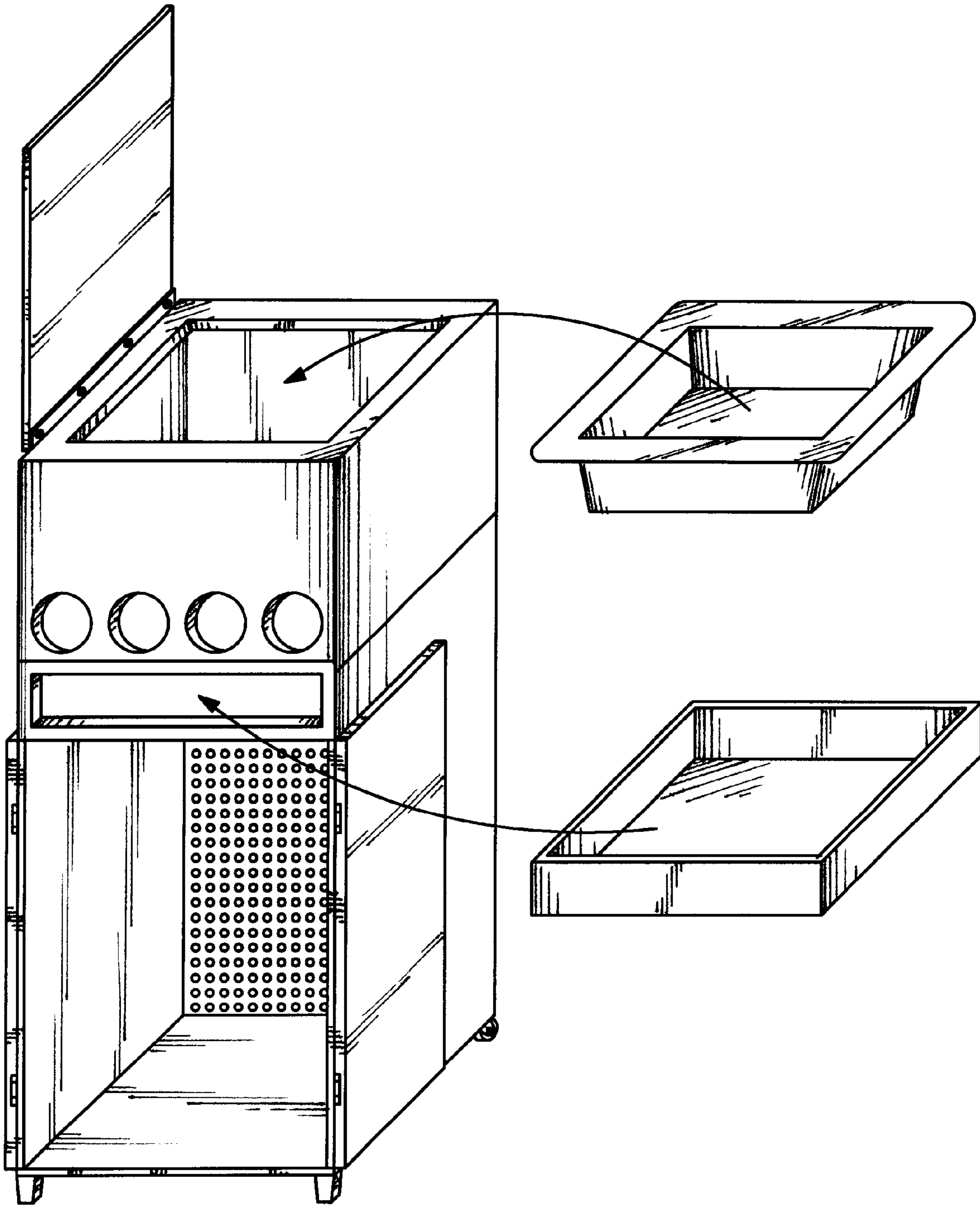

FIG.1

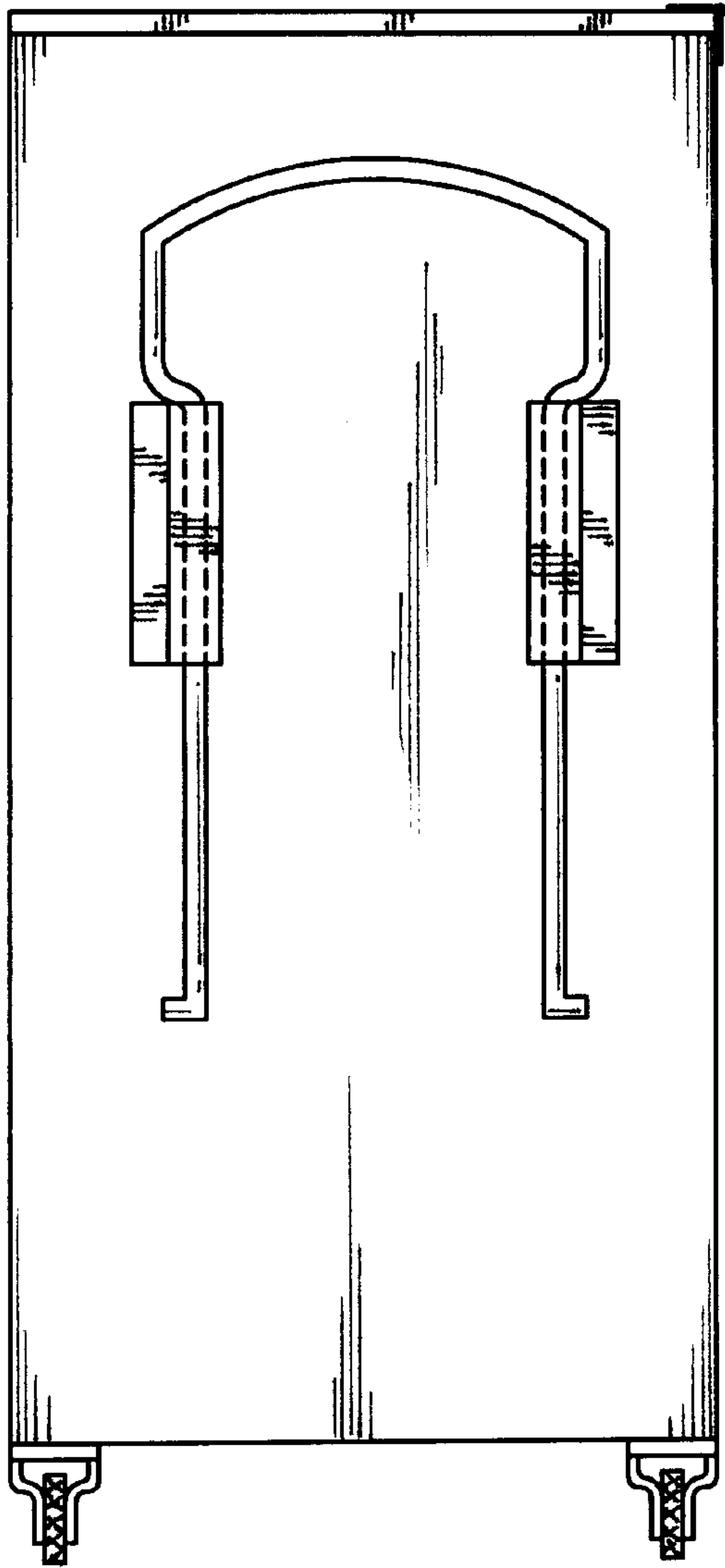

FIG. 2

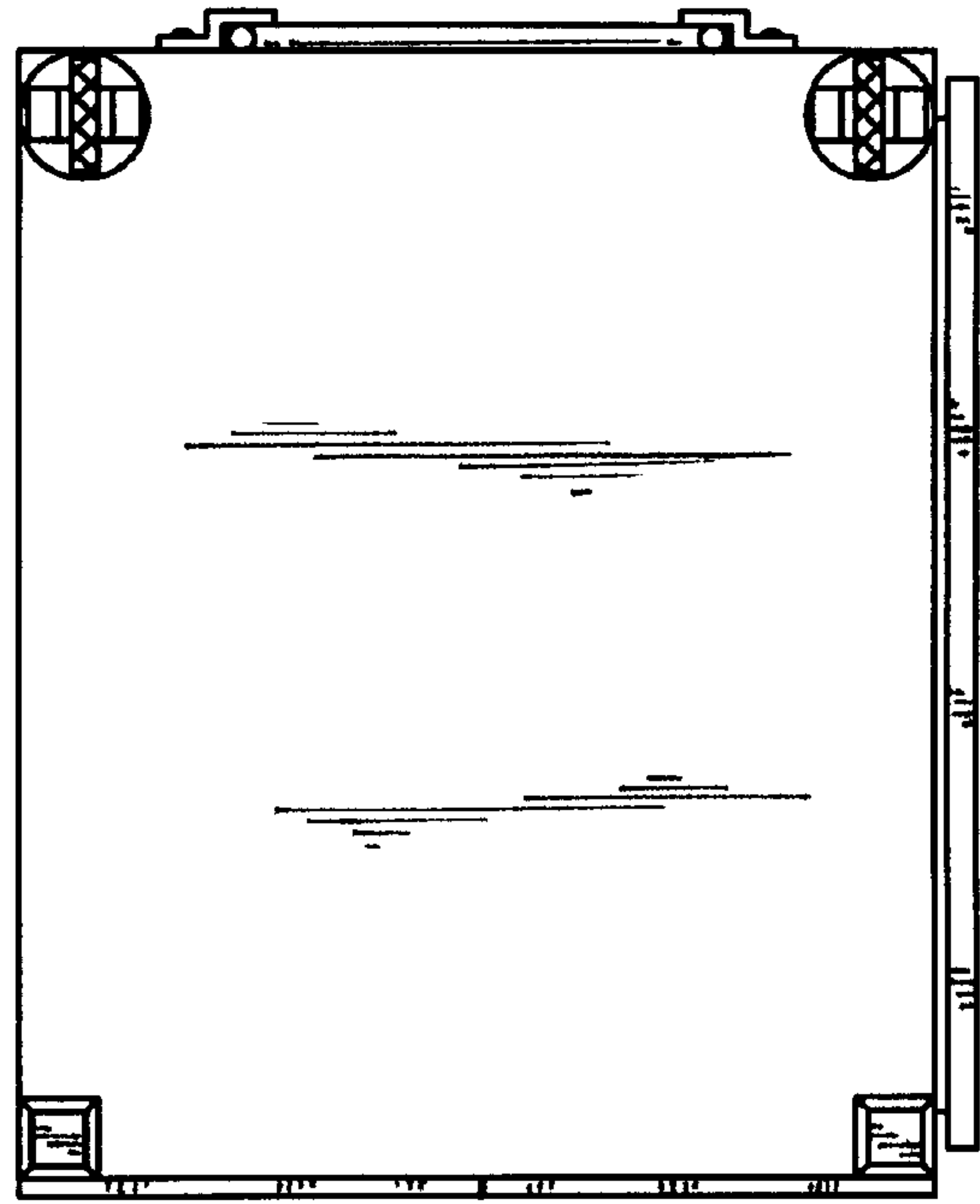

FIG. 5

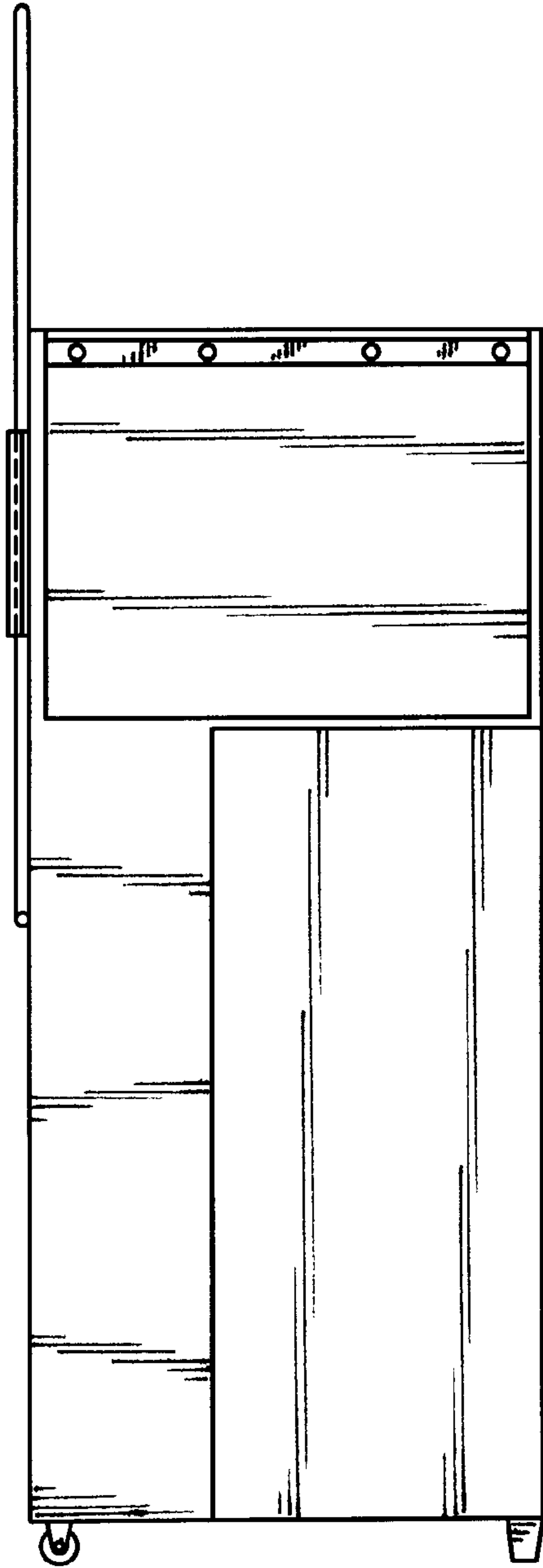

FIG. 3

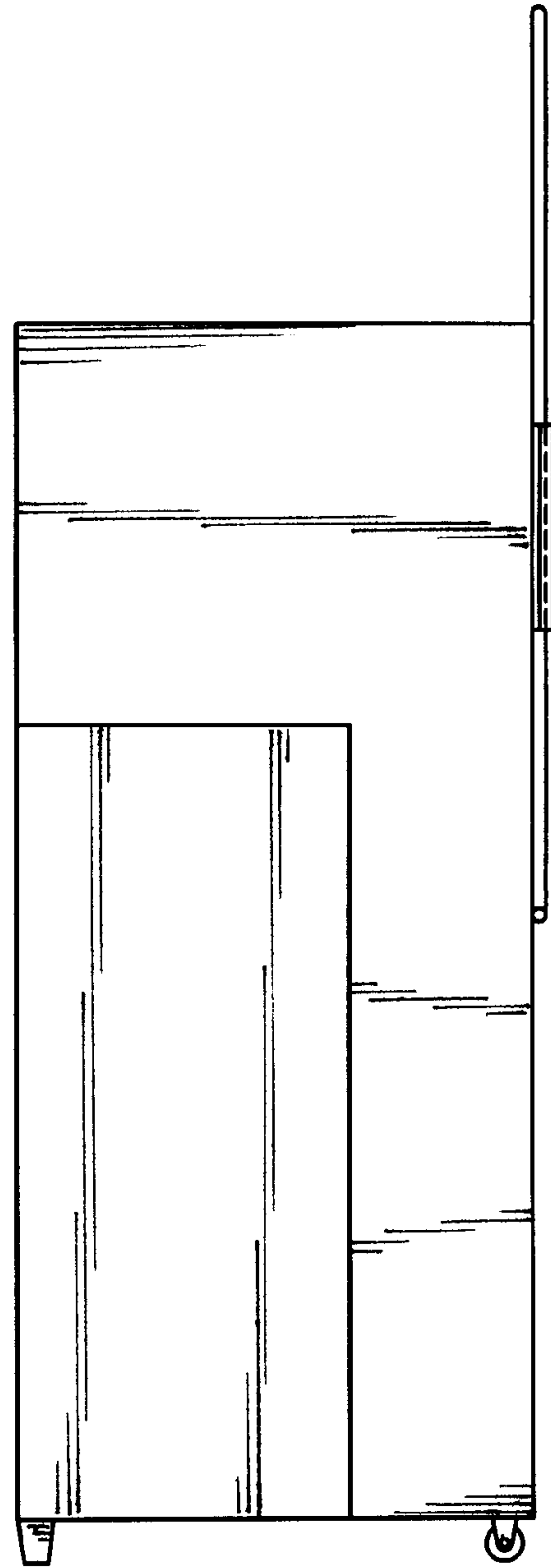

FIG. 4

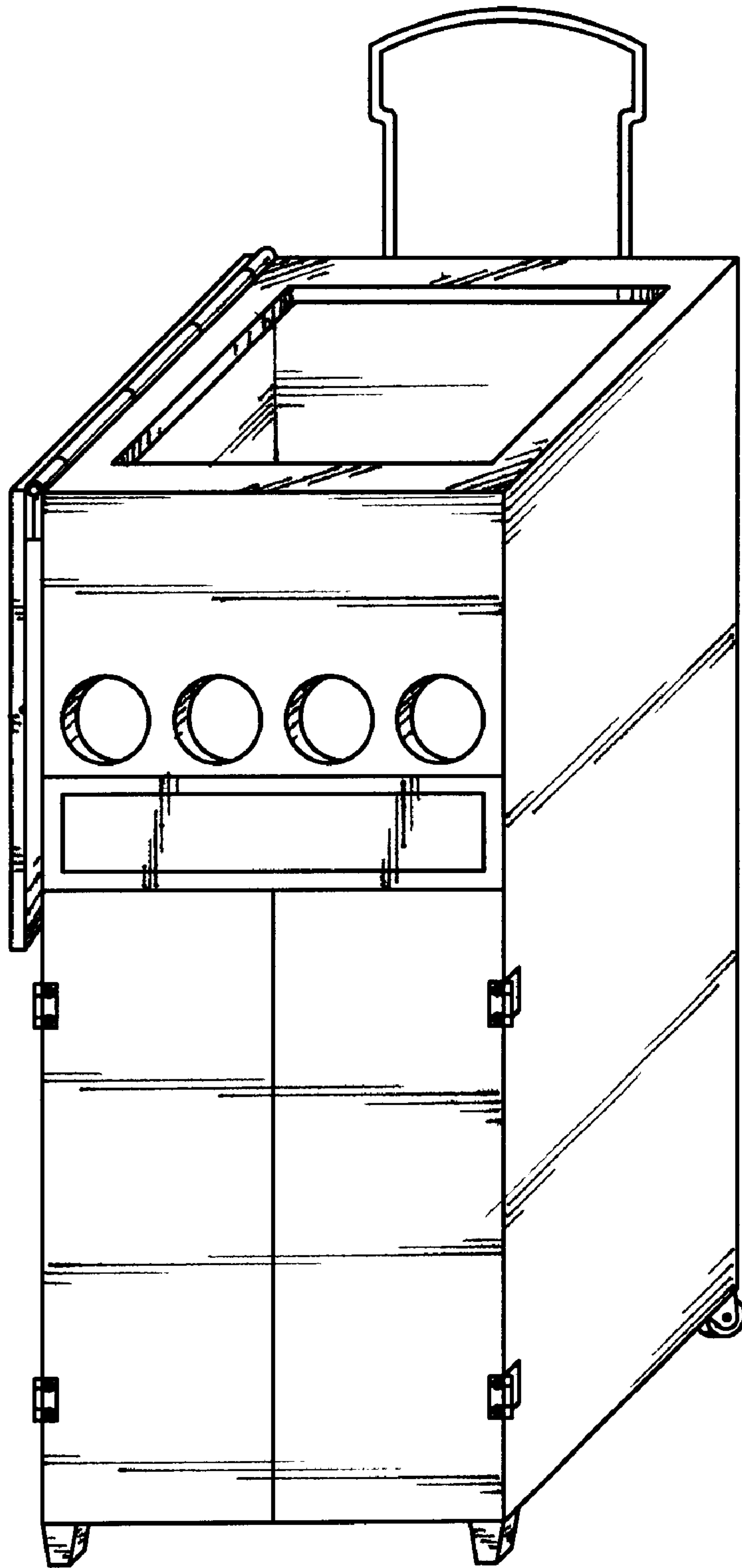

FIG. 6