



US00D531780S

(12) **United States Design Patent**
Nutting

(10) **Patent No.:** **US D531,780 S**
(45) **Date of Patent:** **** Nov. 7, 2006**

(54) **VAMPIRE FANGS COFFIN**

DESCRIPTION

- (76) Inventor: **Donald W. Nutting**, 1295 Ithaca Dr.,
Boulder, CO (US) 80303
 - (**) Term: **14 Years**
 - (21) Appl. No.: **29/200,844**
 - (22) Filed: **Mar. 3, 2004**
 - (51) **LOC (8) Cl.** **99-00**
 - (52) **U.S. Cl.** **D99/3**
 - (58) **Field of Classification Search** D99/1,
D99/34, 35, 37; D3/302; D11/160; D21/483;
D27/106, 110; 27/4, 7, 2, 1, 19, 14; 52/133,
52/128; 229/186
- See application file for complete search history.

FIG. 1 is a perspective view of a vampire fangs coffin showing my new design;
 FIG. 2 is a left side elevation view of the vampire fangs coffin of FIG. 1;
 FIG. 3 is a front end elevation view of the vampire fangs coffin of FIG. 1;
 FIG. 4 is a rear end elevation view of the vampire fangs coffin of FIG. 1;
 FIG. 5 is a perspective view of FIG. 1 with the lid removed;
 FIG. 6 is a top plan view of the vampire fangs coffin of FIG. 1;
 FIG. 7 is a bottom plan view of the vampire fangs coffin of FIG. 1;
 FIG. 8 is a perspective view of a second embodiment of a vampire fangs coffin showing my new design in a stacked position;
 FIG. 9 is a left side elevation view of the stacked vampire fangs coffins of FIG. 8;
 FIG. 10 is a front end elevation view of the stacked vampire fangs coffins of FIG. 8;
 FIG. 11 is a rear end elevation view of the stacked vampire fangs coffins of FIG. 8;
 FIG. 12 is a perspective view of FIG. 8 with the lid removed;
 FIG. 13 is a top plan view of the stacked vampire fangs coffins of FIG. 8;
 FIG. 14 is a bottom plan view of the stacked vampire fangs coffins of FIG. 8;
 FIG. 15 is a perspective view of a third embodiment of a vampire fangs coffin in a stacked position;
 FIG. 16 is a left side elevation view of the stacked vampire fangs coffins of FIG. 15;
 FIG. 17 is a front end elevation view of the stacked vampire fangs coffins of FIG. 15;
 FIG. 18 is a rear end elevation view of the stacked vampire fangs coffins of FIG. 15;
 FIG. 19 is a perspective view of FIG. 15 with the lid removed.
 FIG. 20 is a top plan view of the stacked vampire fangs coffins of FIG. 15; and,
 FIG. 21 is a bottom plan view of the stacked vampire fangs coffins of FIG. 15;

(56) **References Cited**

U.S. PATENT DOCUMENTS

D37,581 S	*	10/1905	Ellis	D27/110
D199,716 S	*	12/1964	Gluck	D27/106
4,517,713 A	*	5/1985	Swallert	27/4
4,854,018 A	*	8/1989	Von Bratt	27/19
4,891,869 A	*	1/1990	Nutting	27/4
5,111,559 A	*	5/1992	Mohr et al.	27/4
5,307,545 A	*	5/1994	Stoltz	27/4
D419,260 S		1/2000	Manzo, Jr.		
D437,099 S		1/2001	Nutting et al.		
D460,354 S		7/2002	Goldiner et al.		
6,502,354 B1	*	1/2003	McClure et al.	52/133
D494,229 S	*	8/2004	Akers	D21/483

OTHER PUBLICATIONS

Foothills Ltd 1998 Catalog.

* cited by examiner

Primary Examiner—Paula A. Greene

(74) *Attorney, Agent, or Firm*—Brian D. Smith, P.C.

(57) **CLAIM**

The ornamental design for vampire fangs coffin, as shown and described.

1 Claim, 6 Drawing Sheets

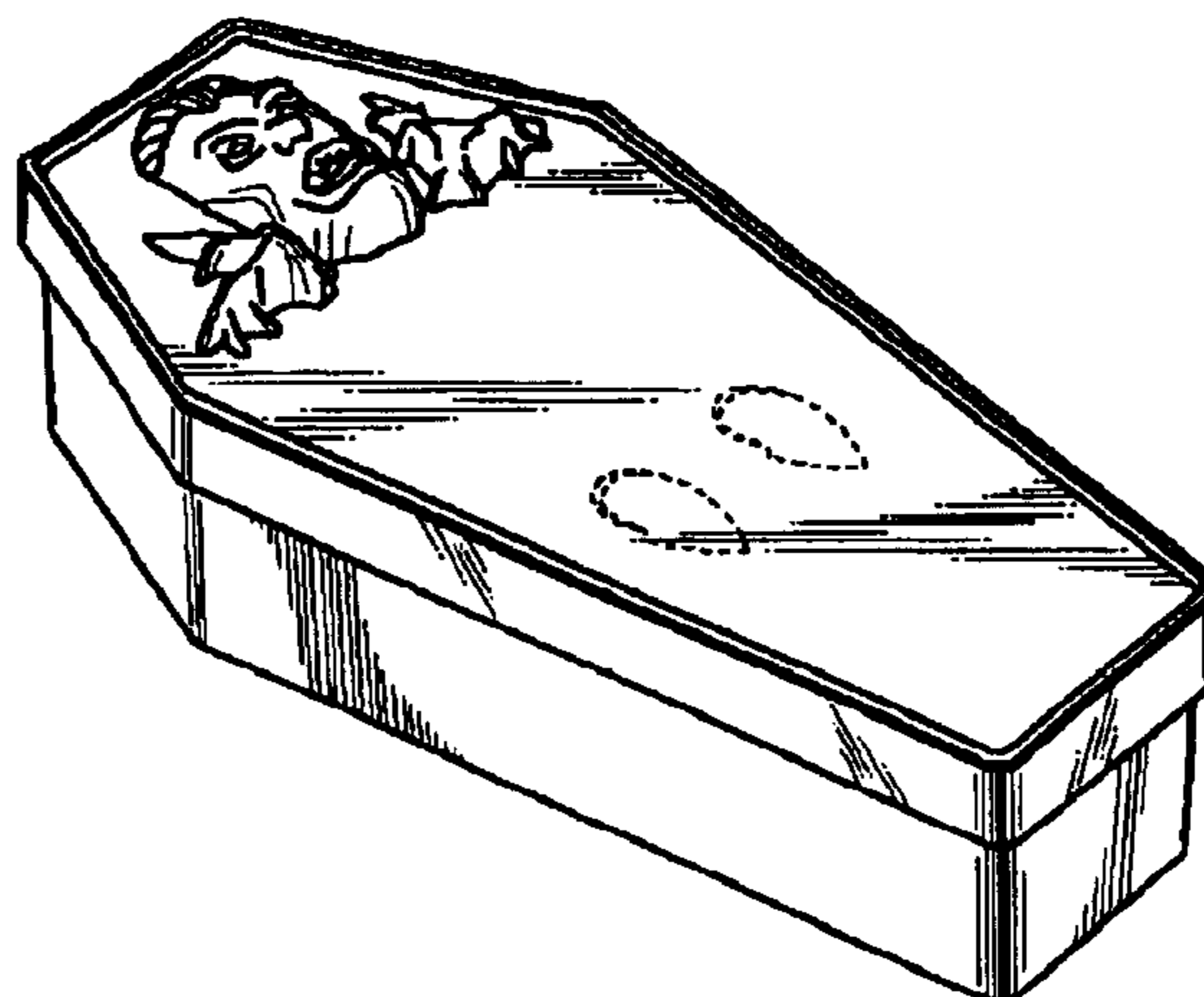

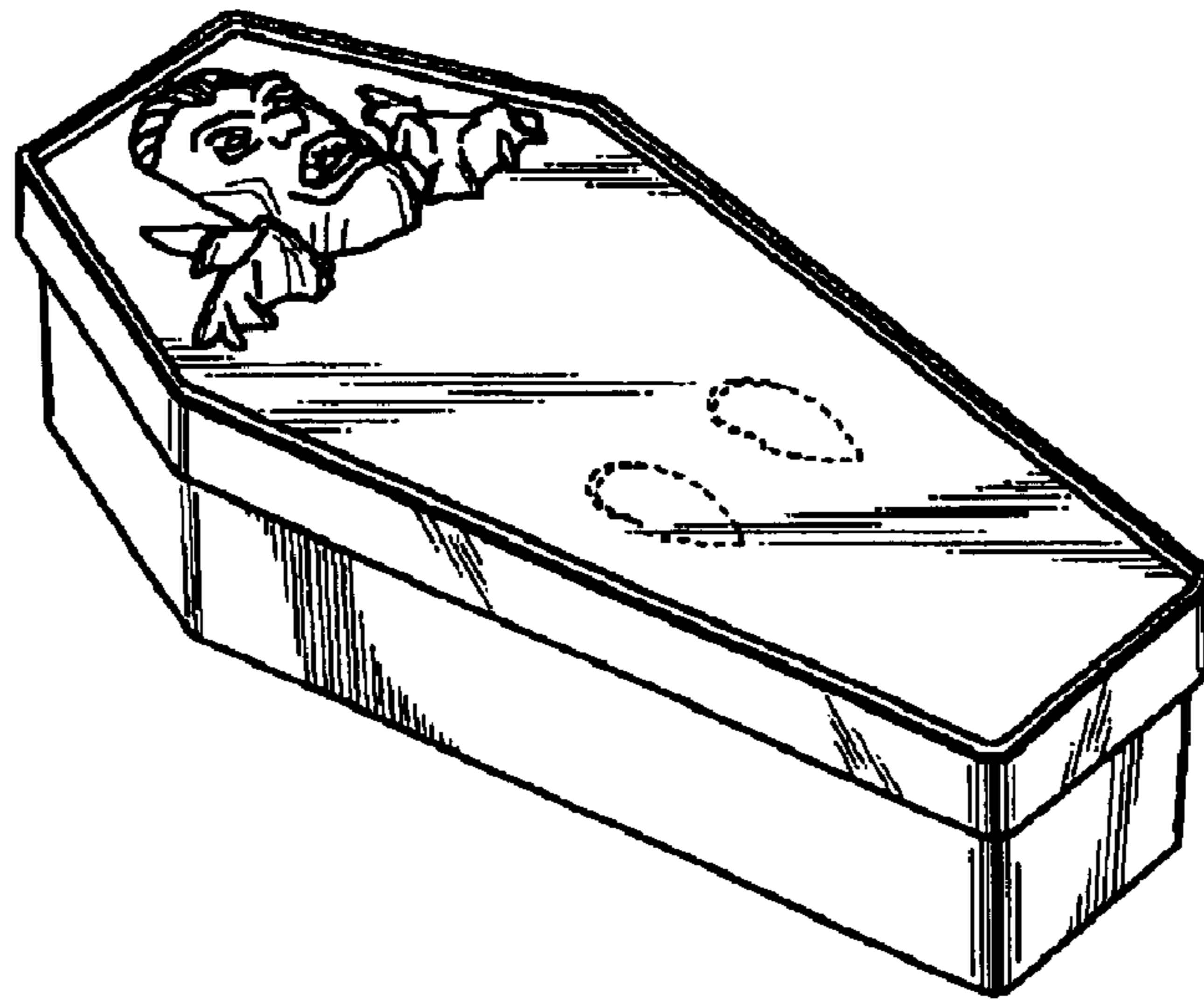

FIG. 1

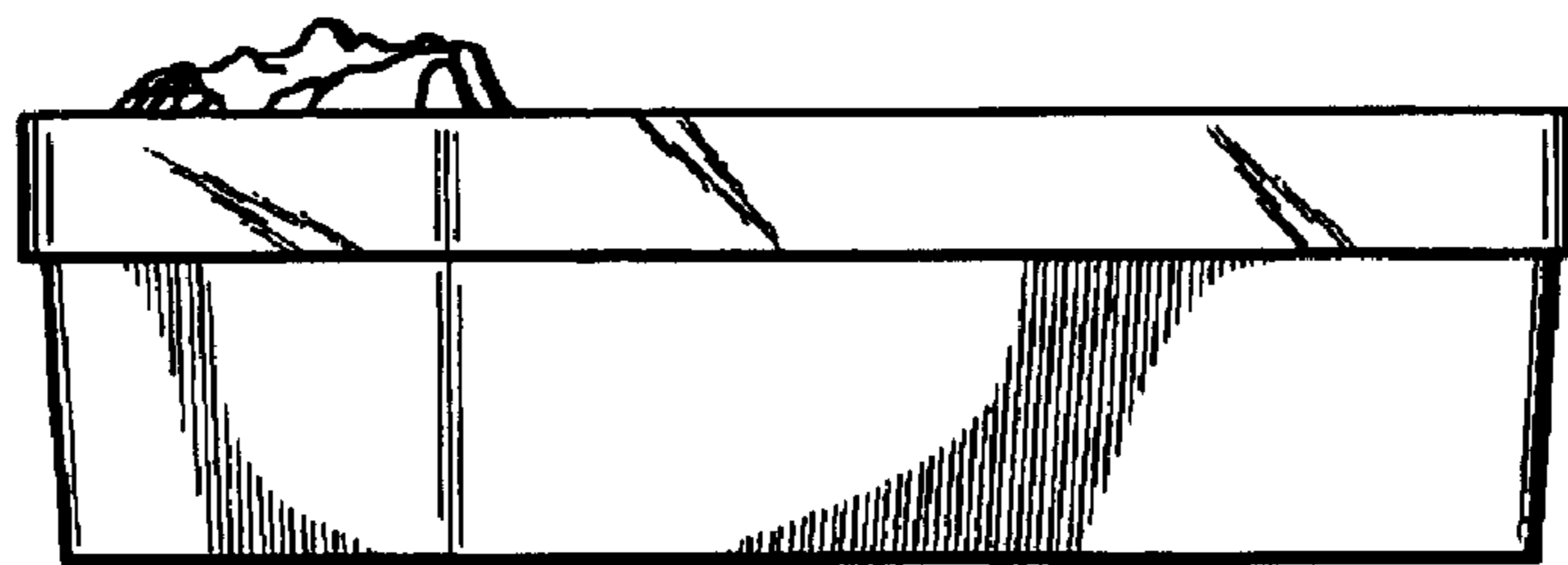

FIG. 2

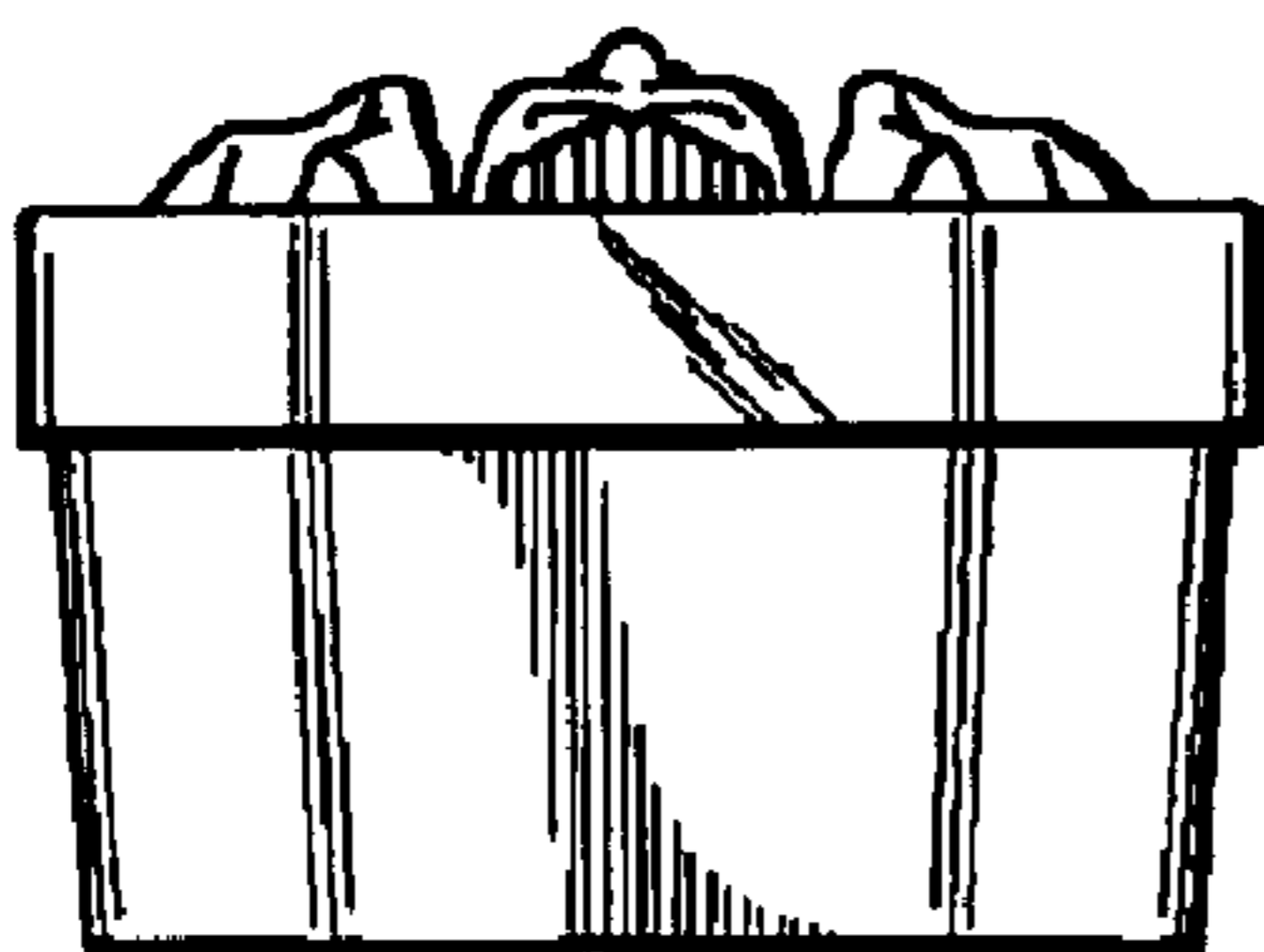

FIG. 3

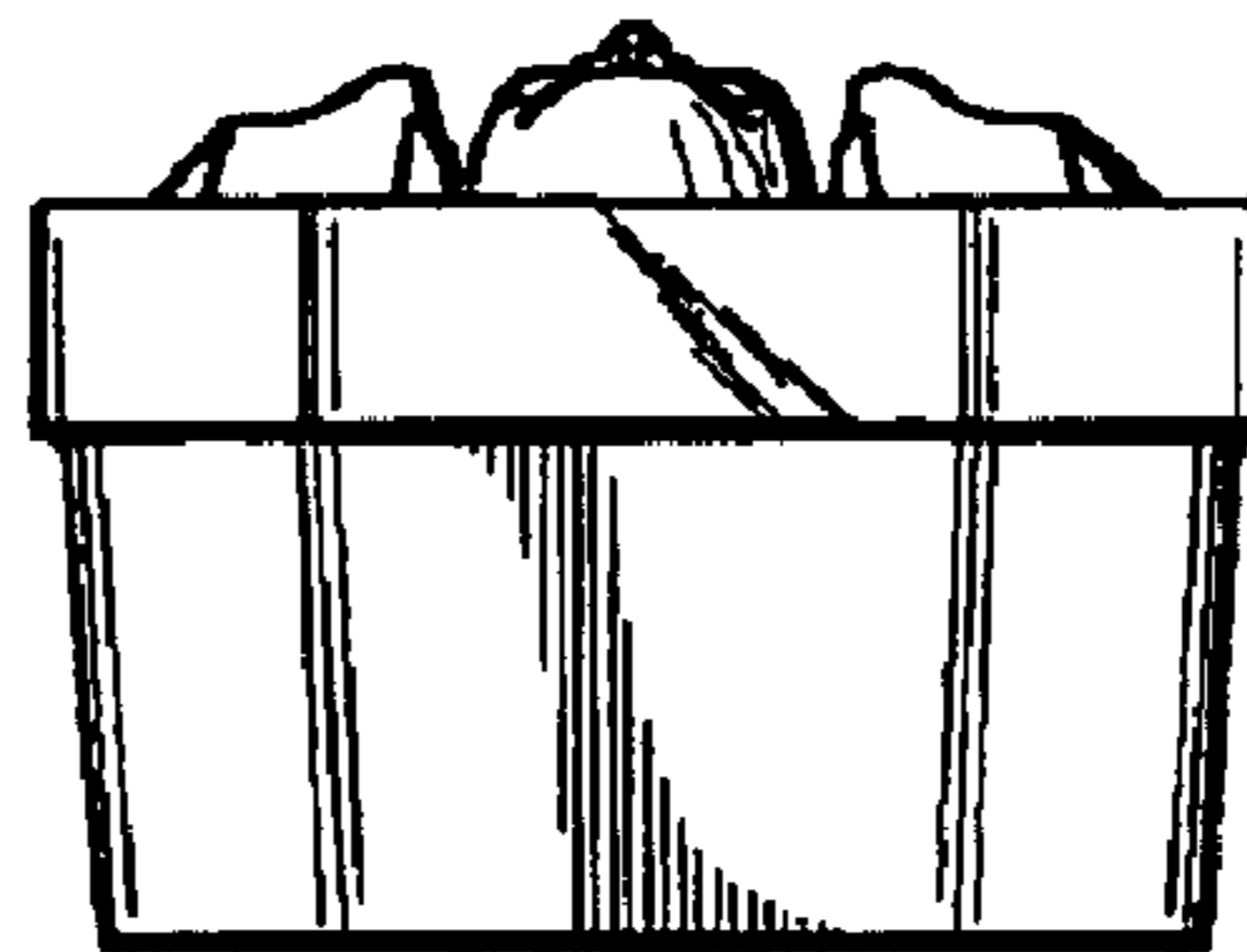

FIG. 4

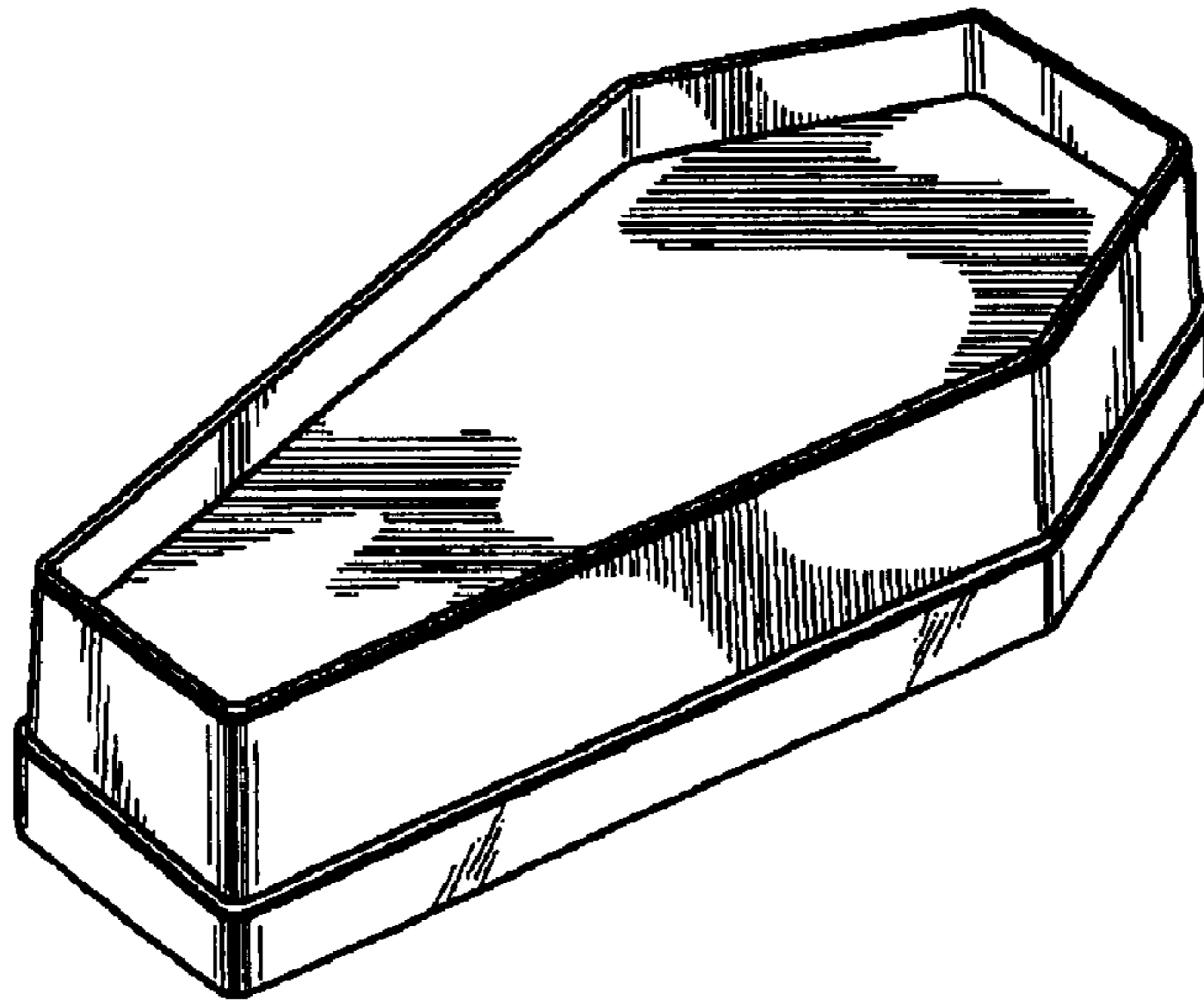

FIG. 5

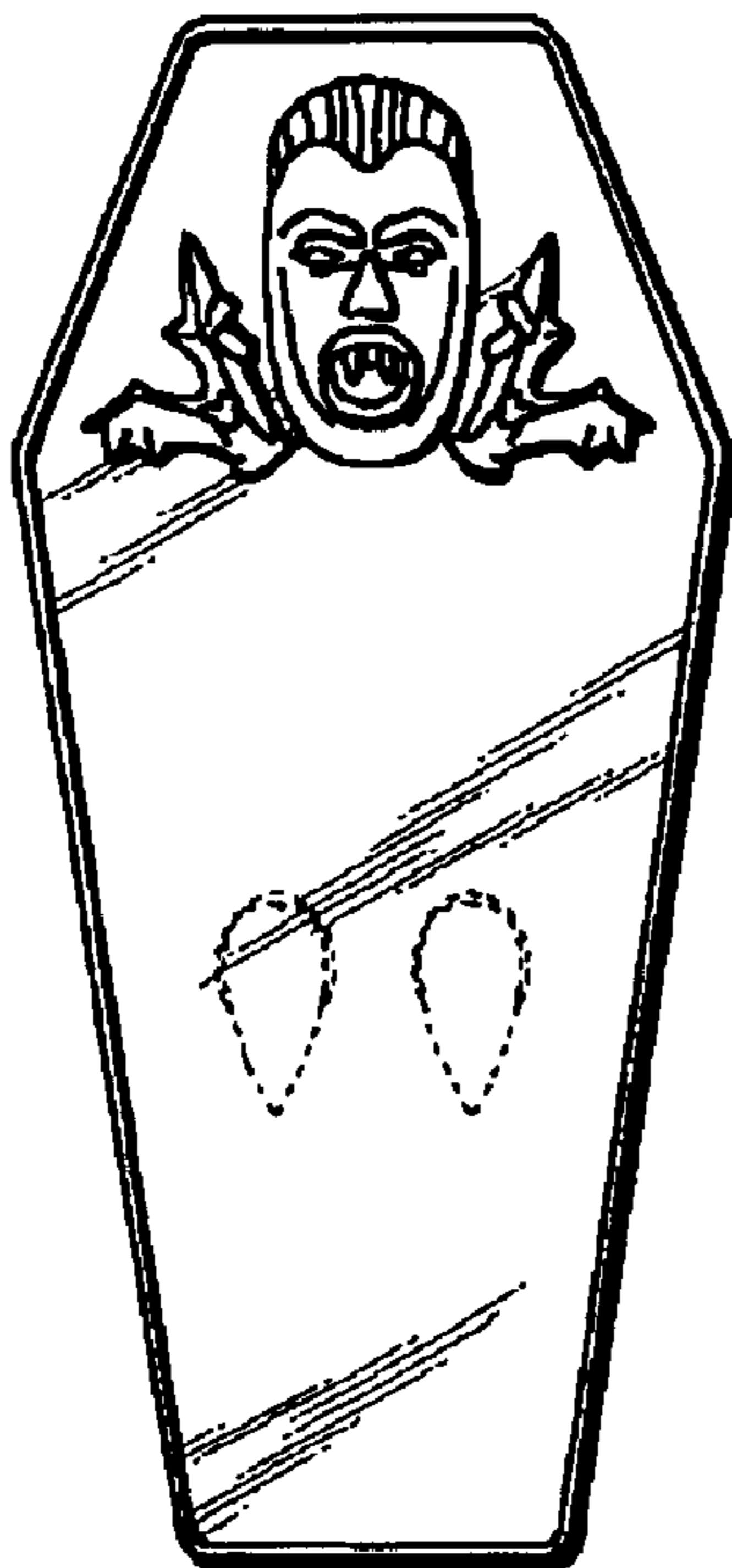

FIG. 6

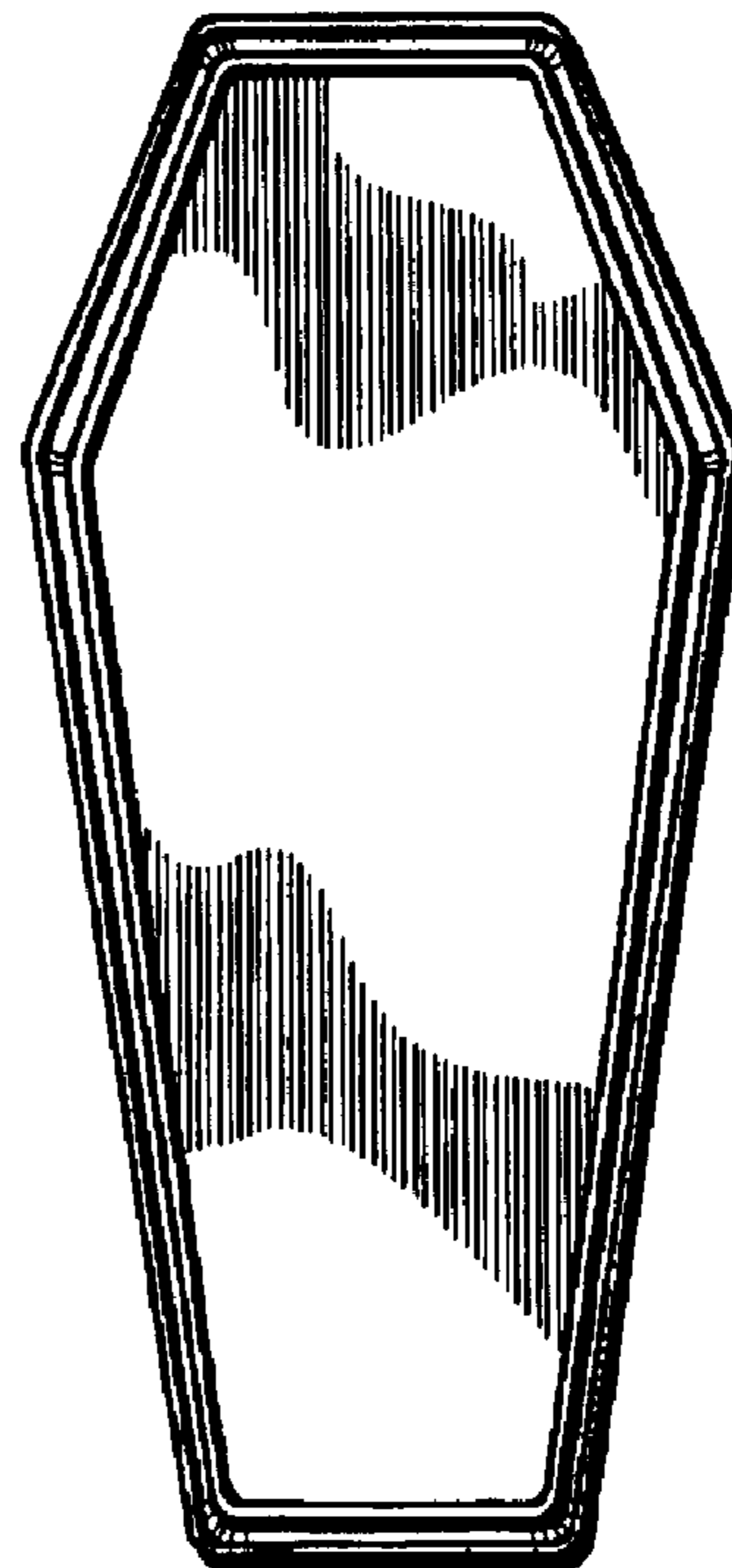

FIG. 7

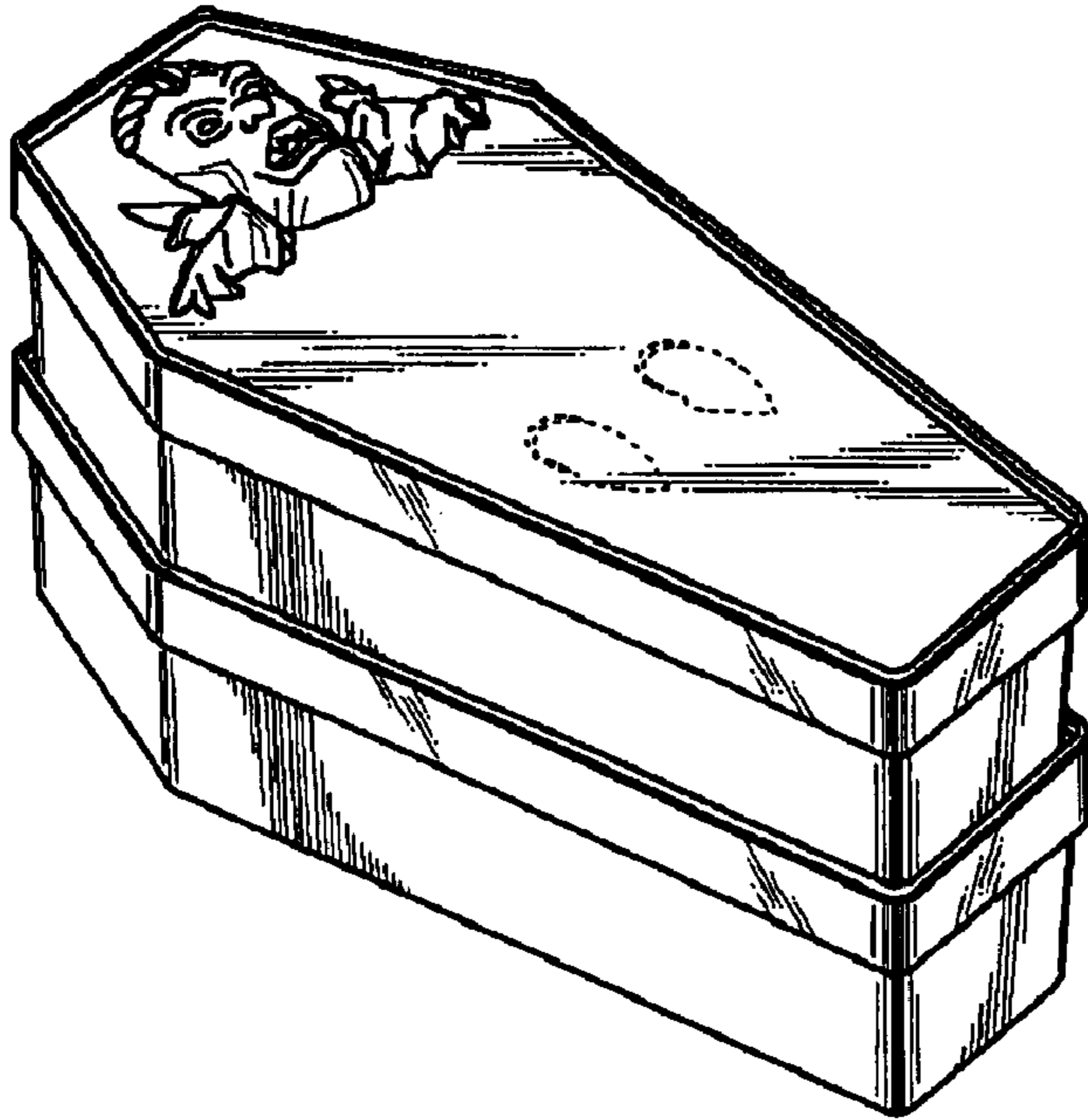

FIG. 8

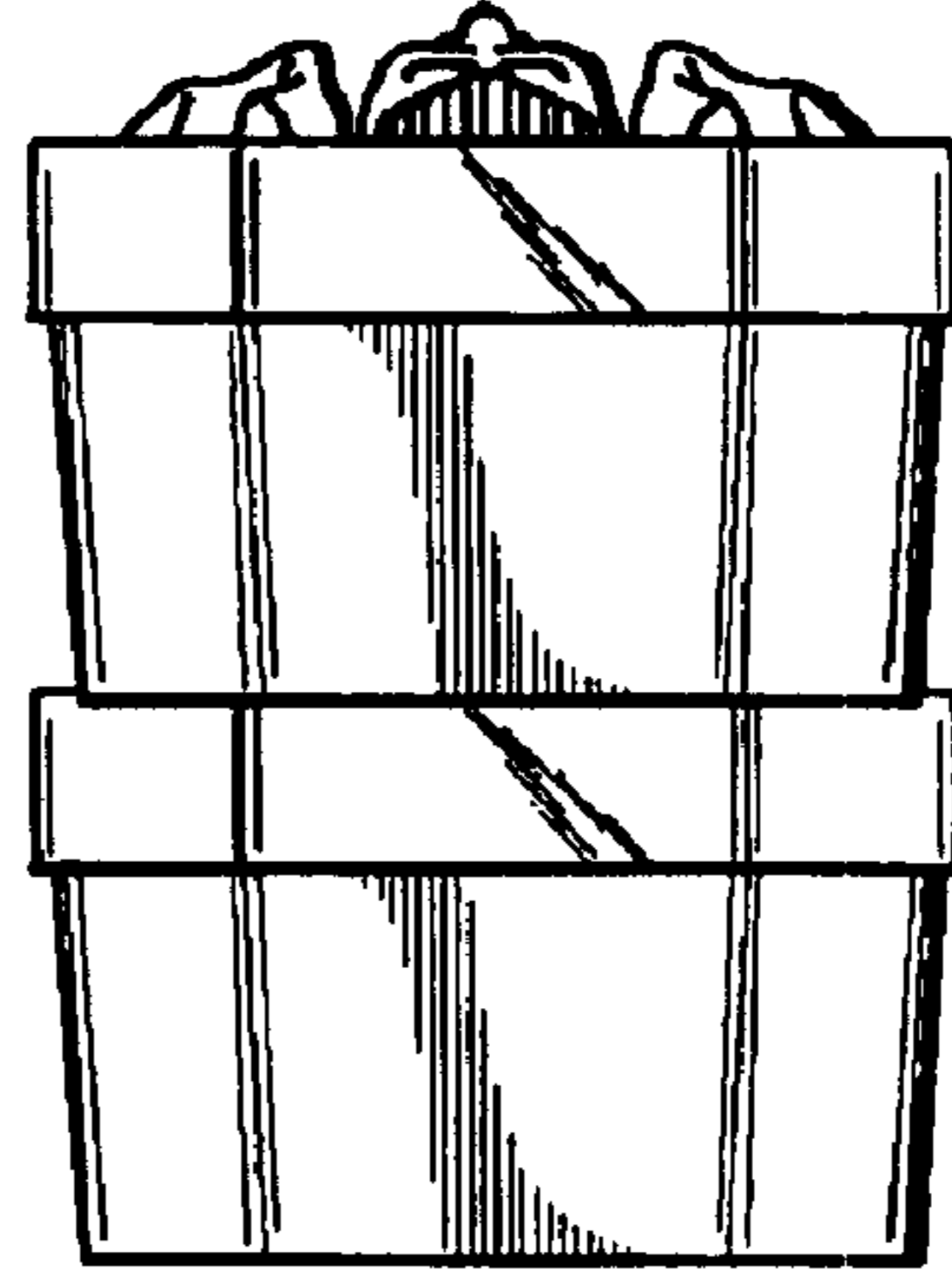

FIG. 10

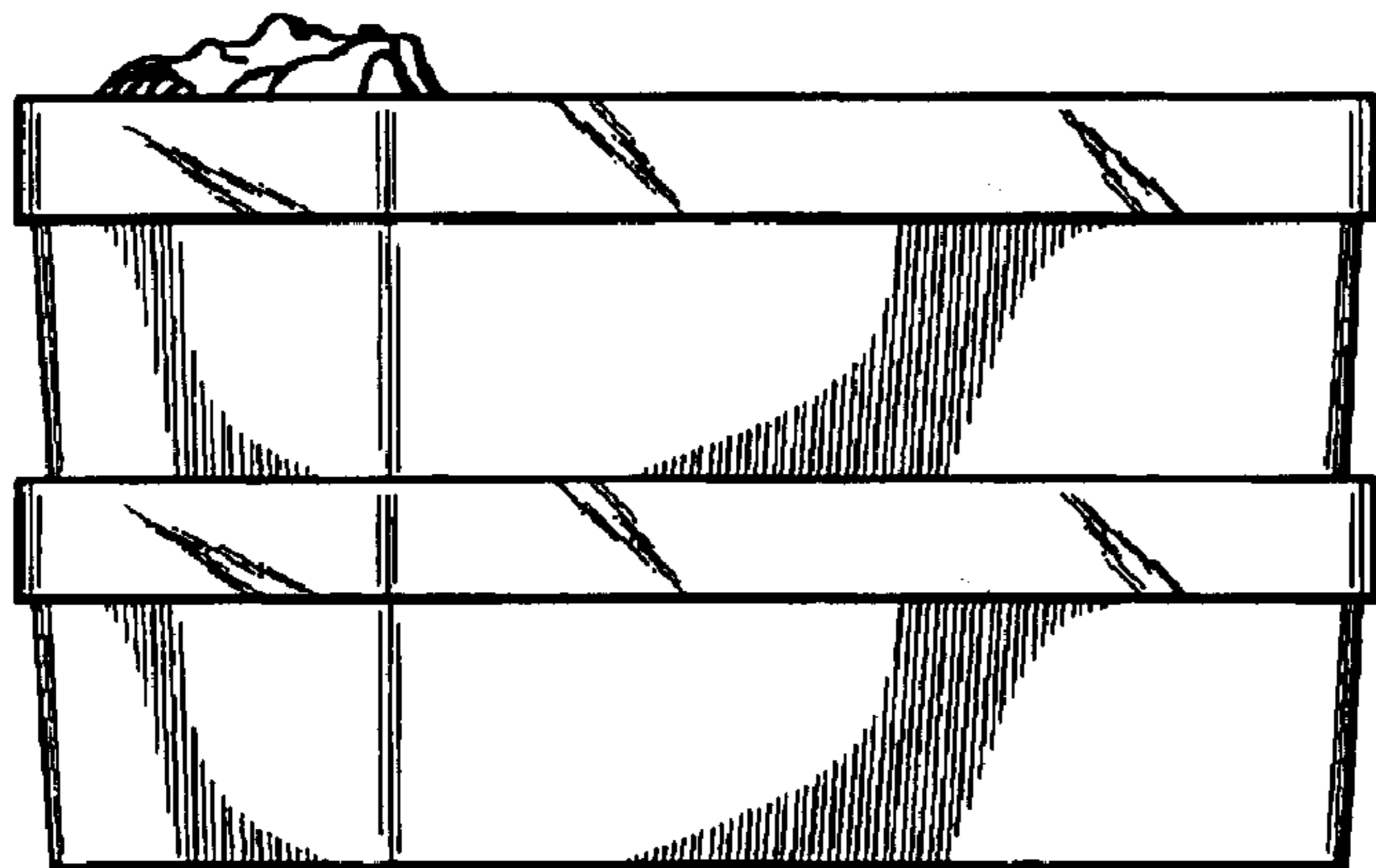

FIG. 9

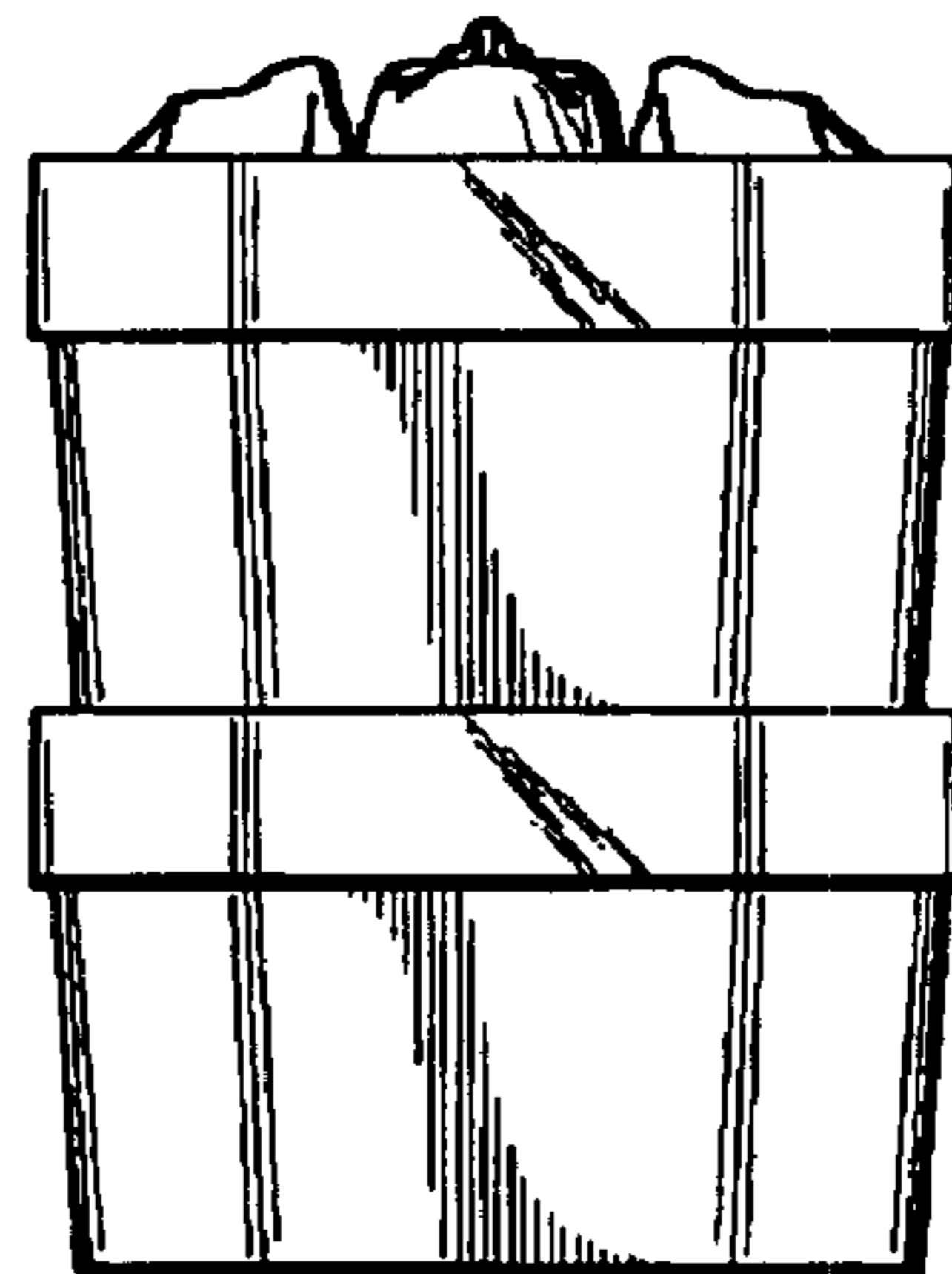

FIG. 11

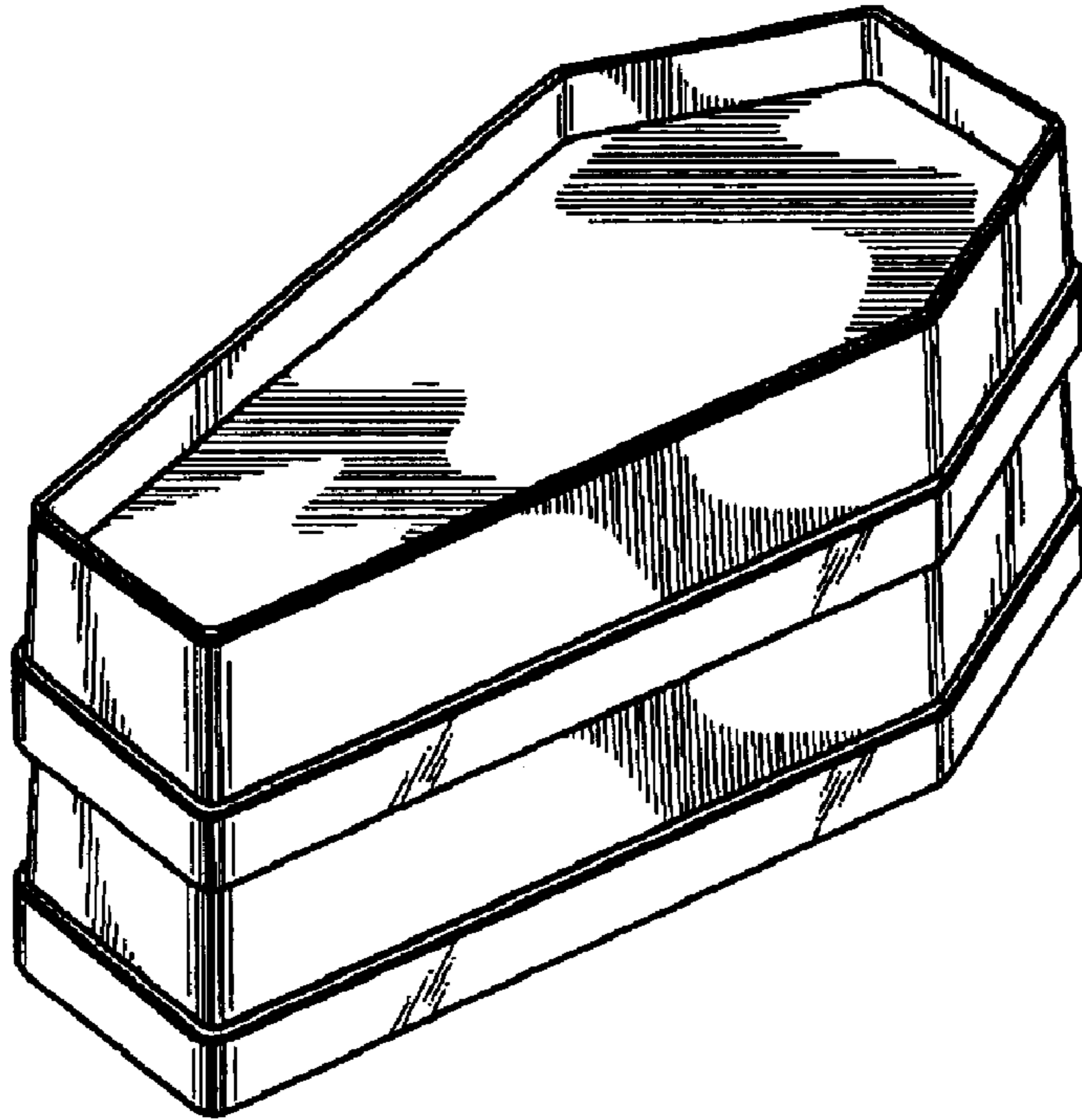

FIG. 12

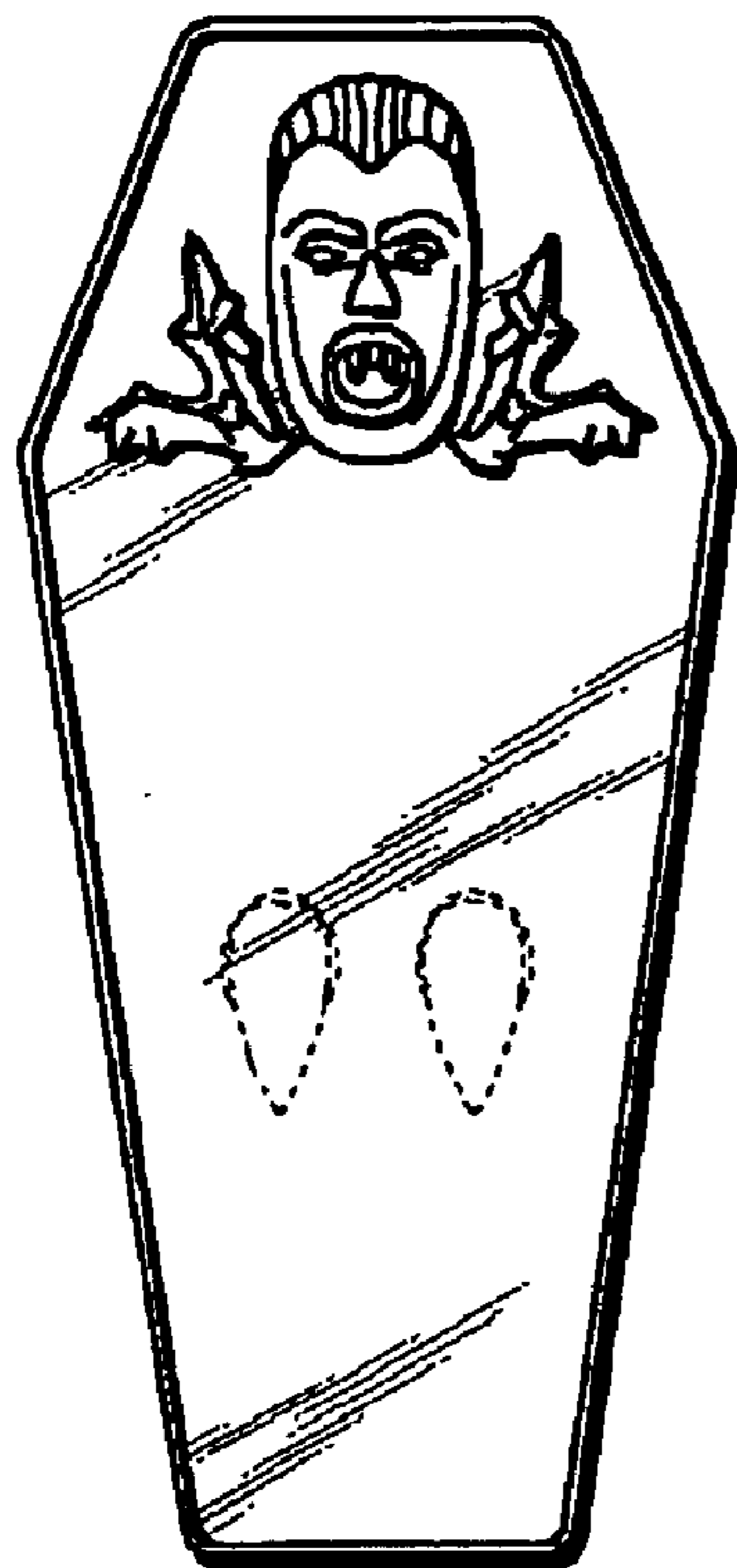

FIG. 13

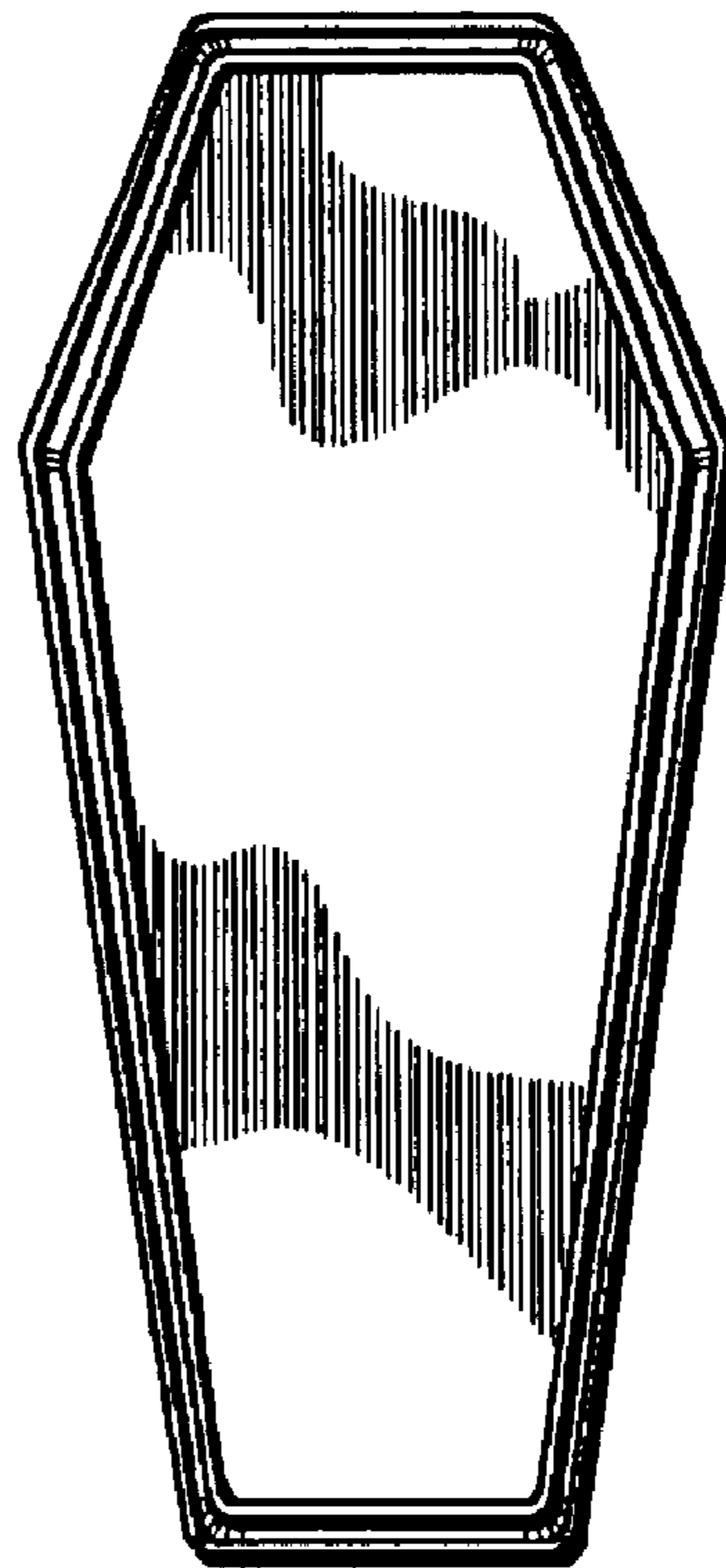

FIG. 14

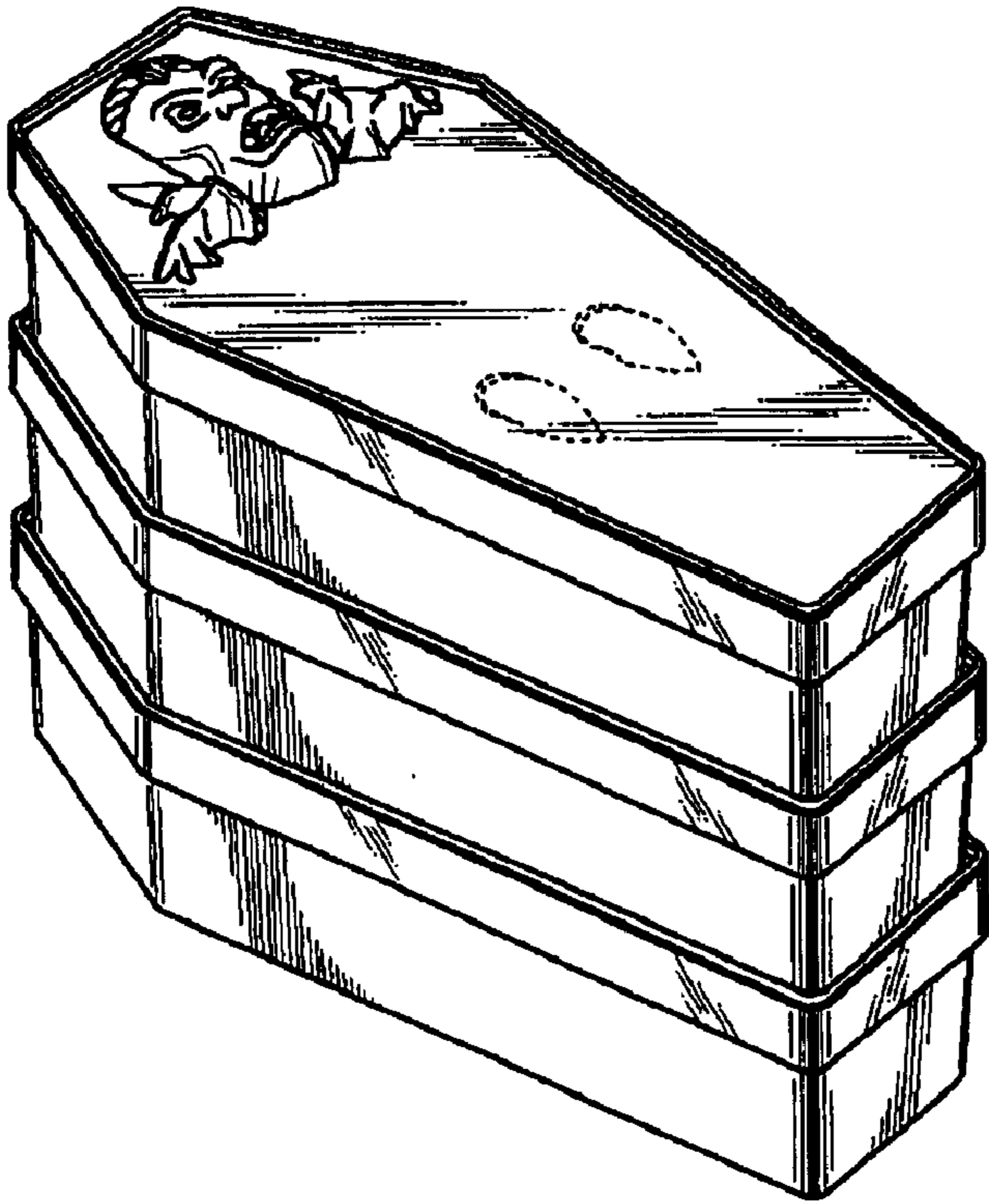

FIG. 15

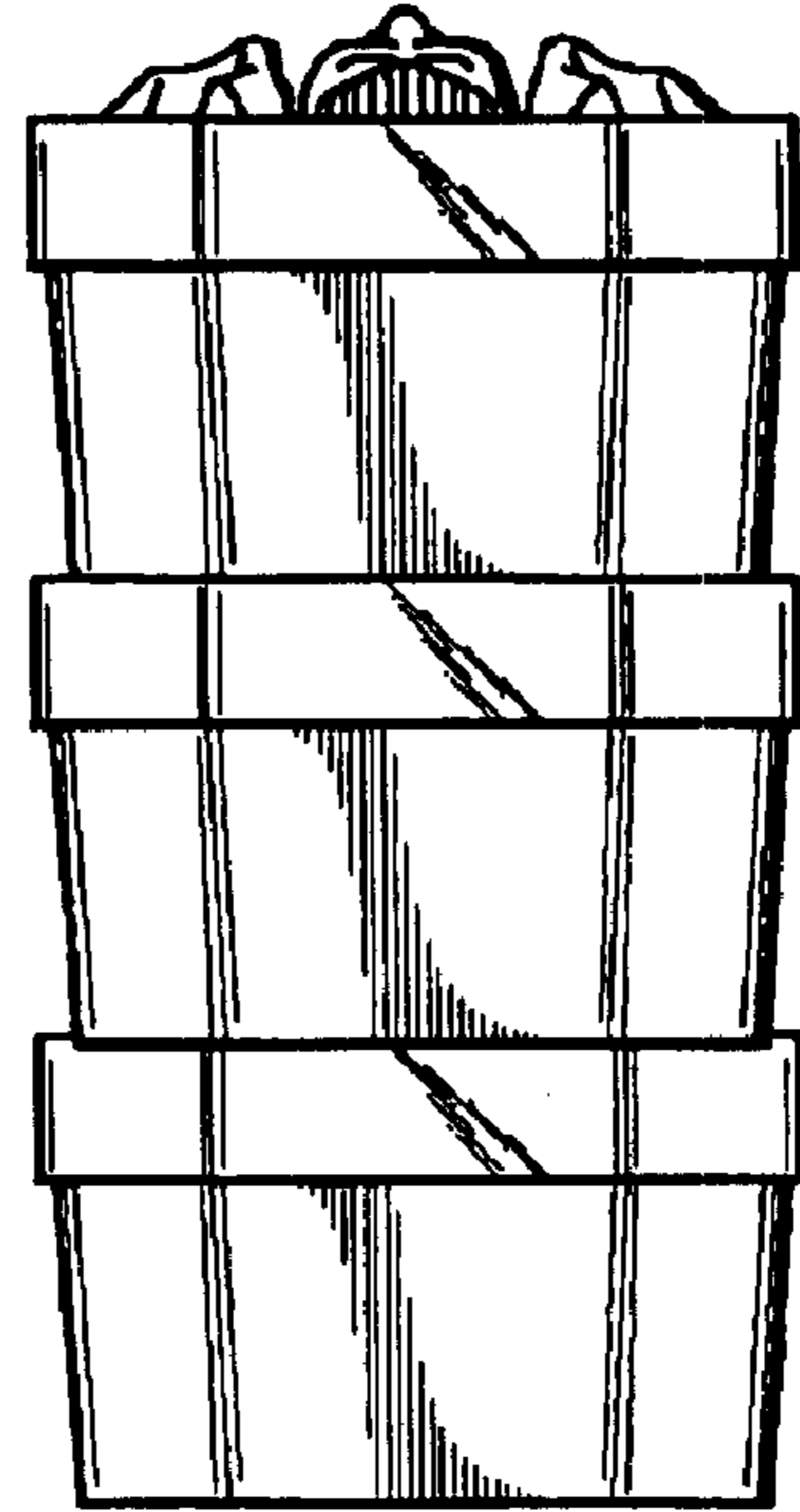

FIG. 17

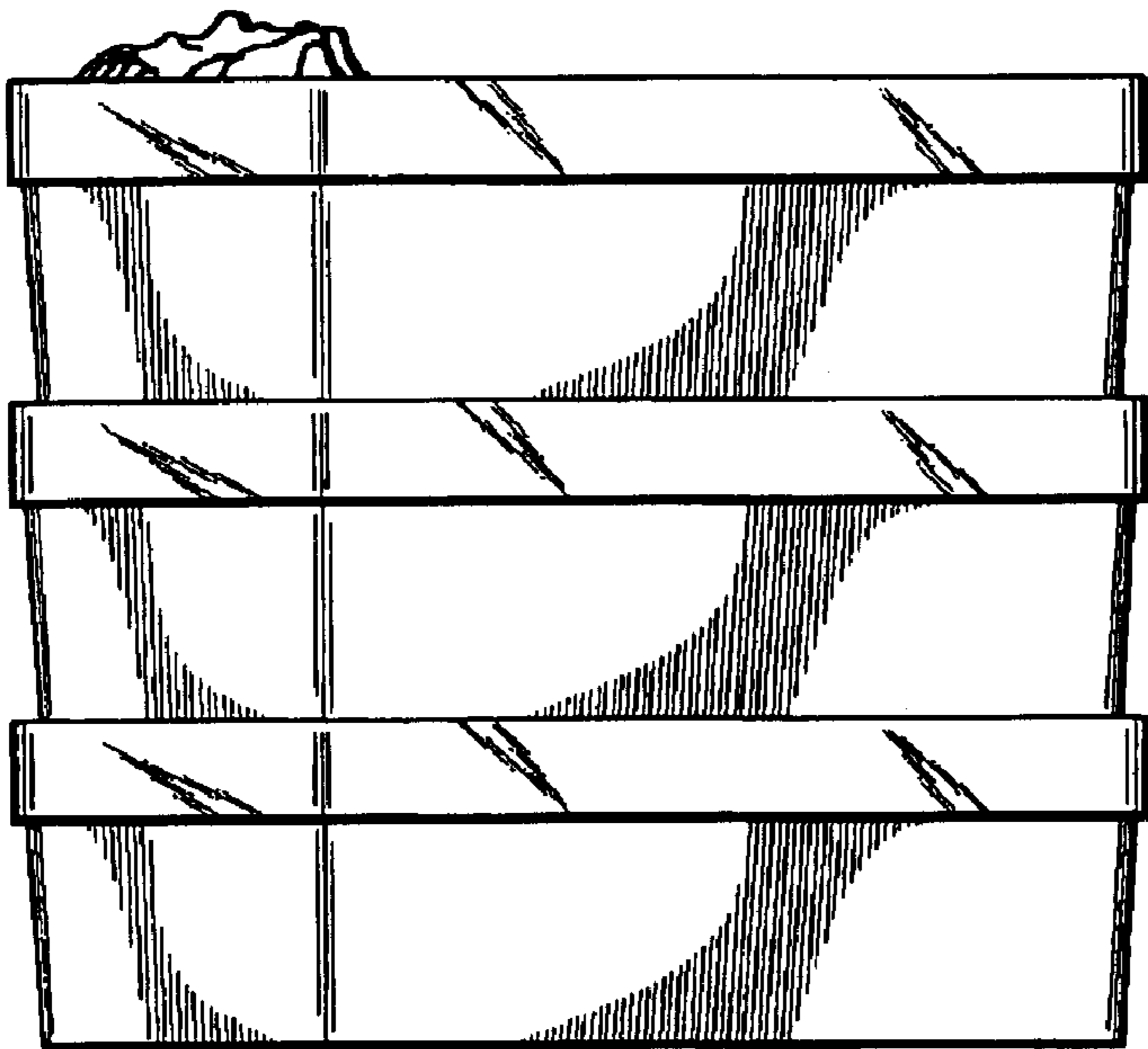

FIG. 16

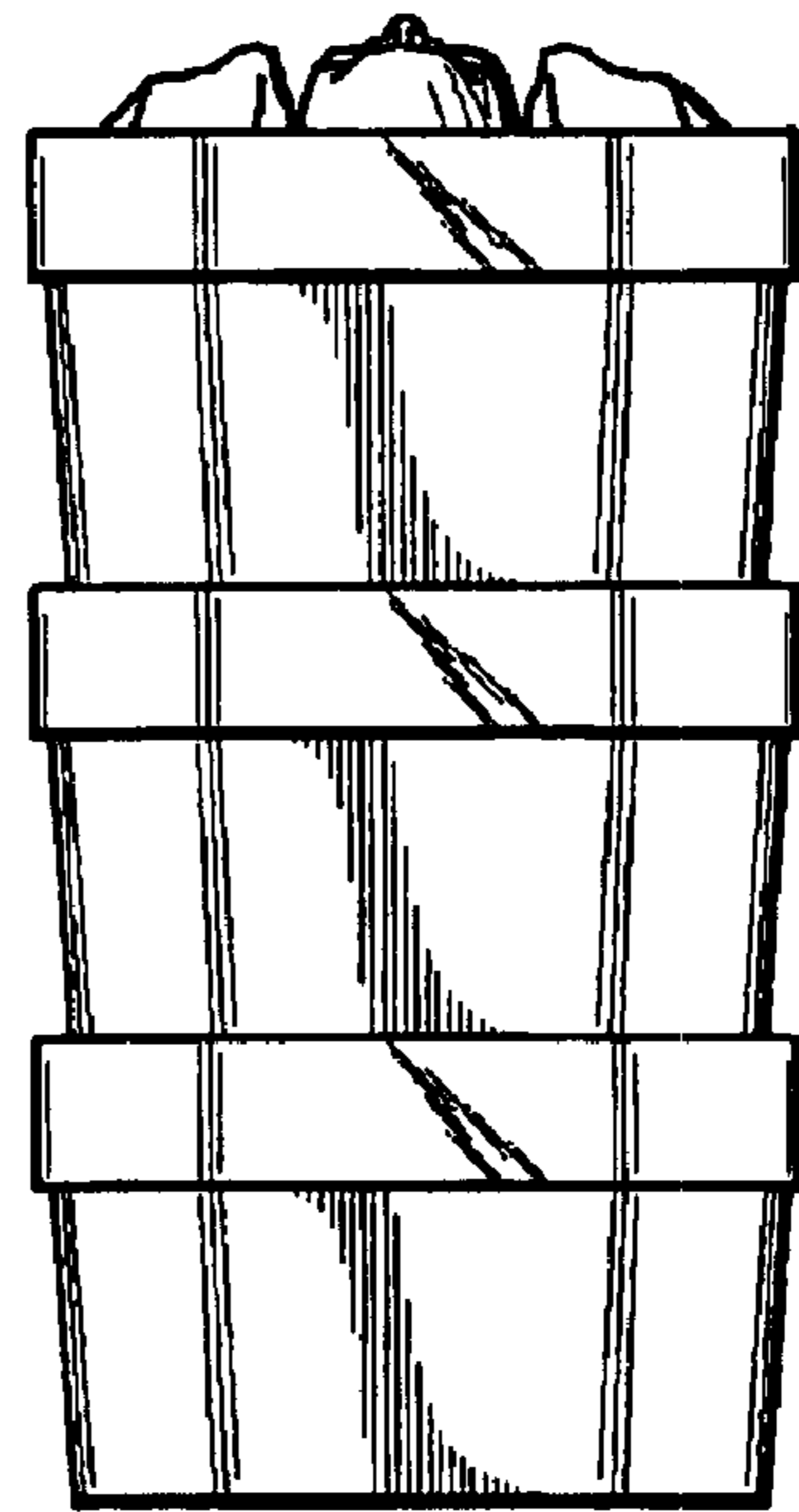

FIG. 18

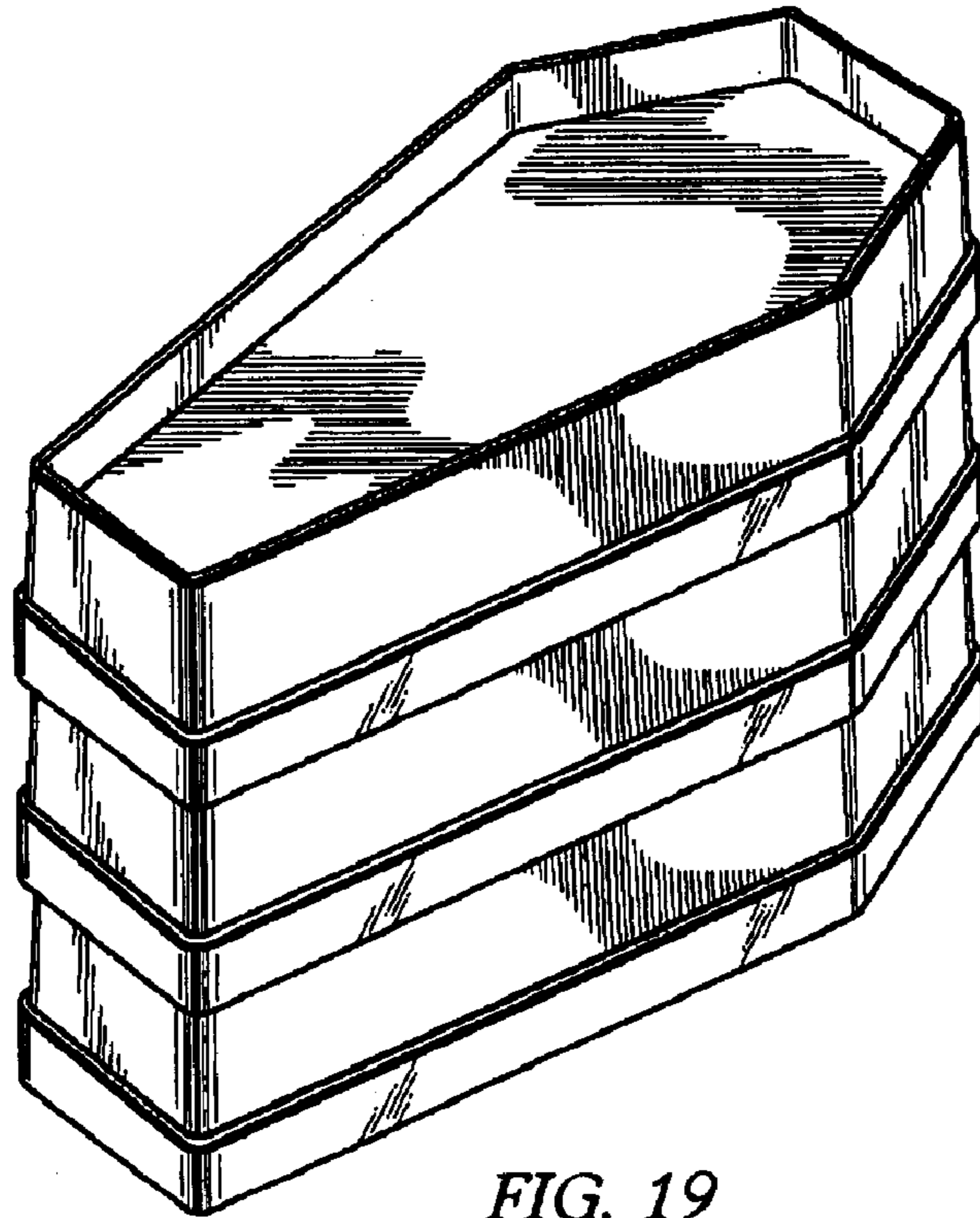

FIG. 19

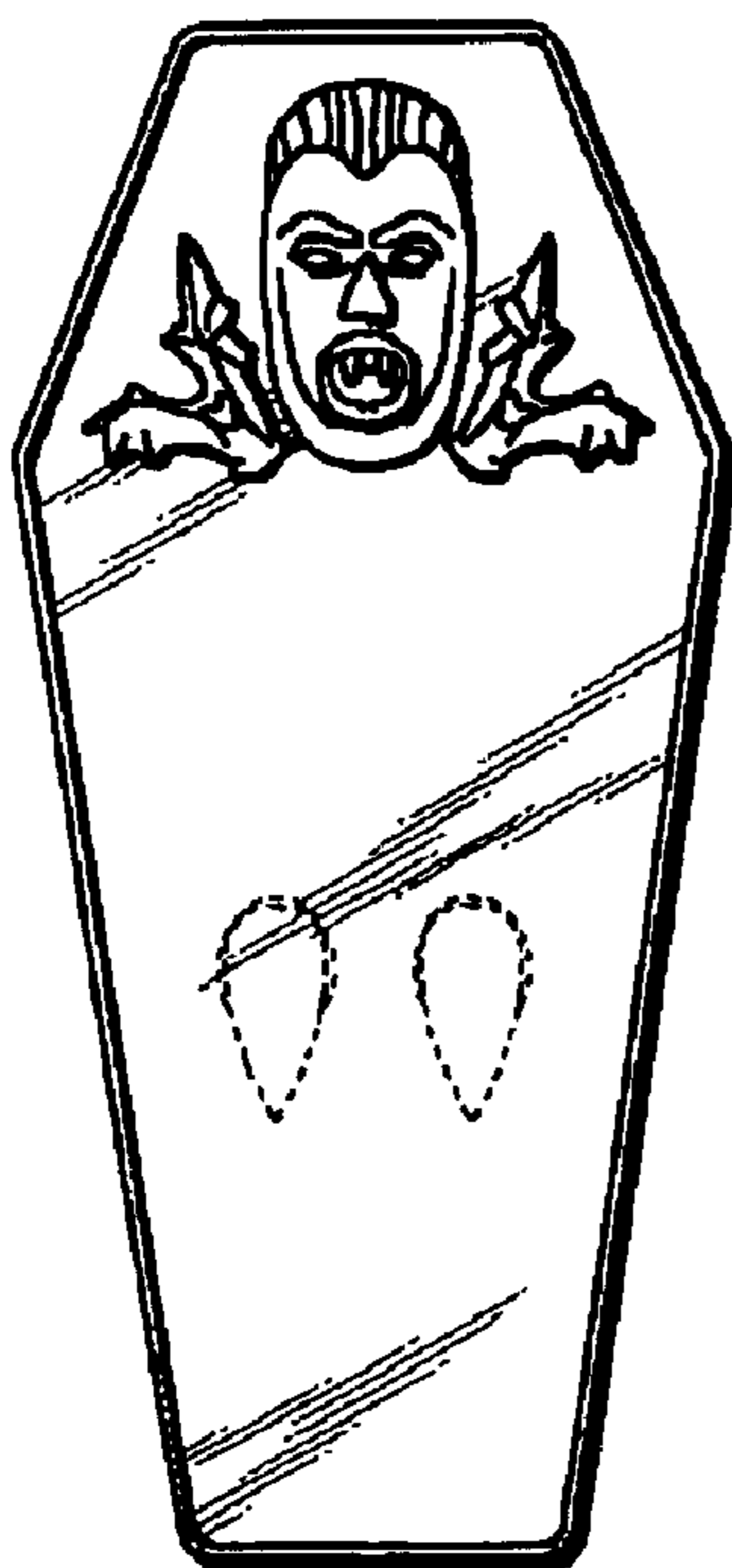

FIG. 20

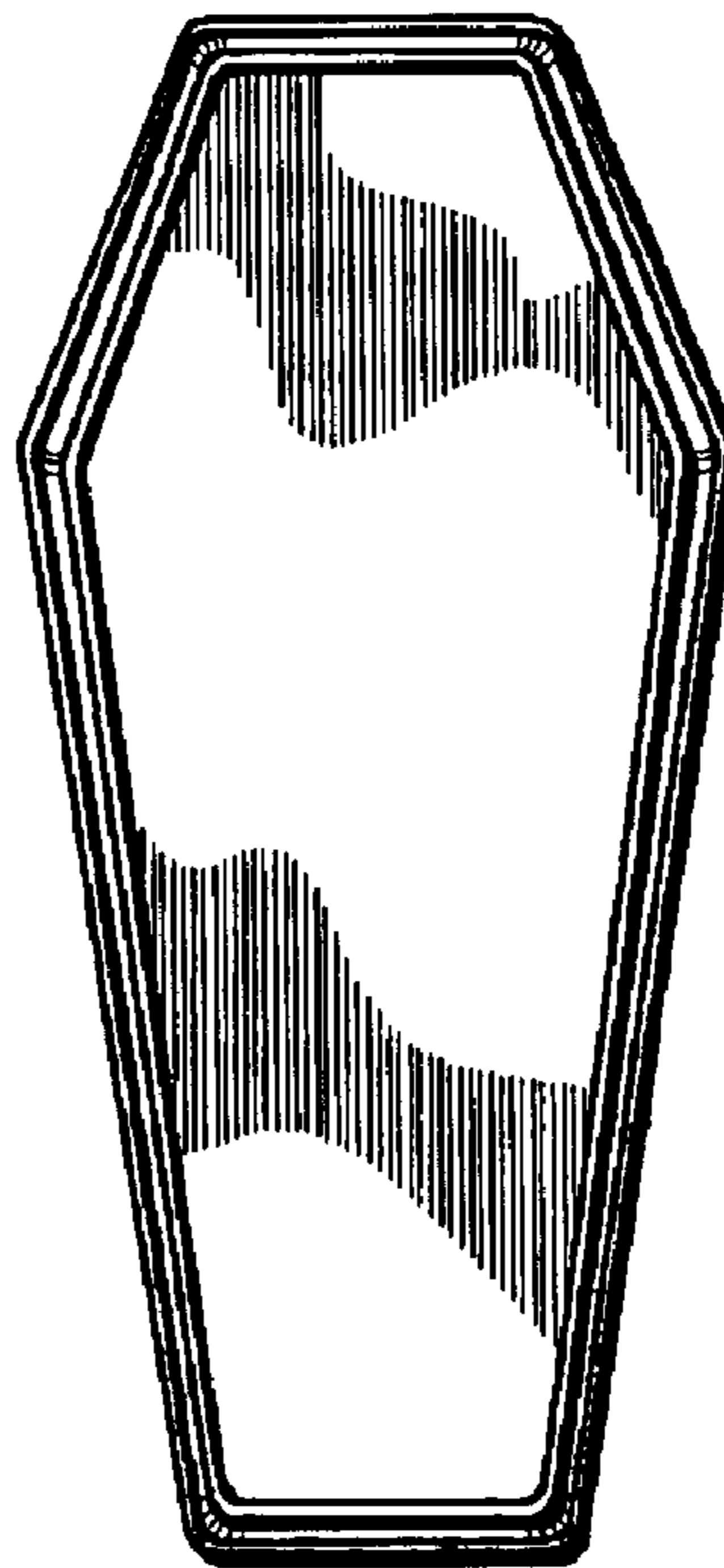

FIG. 21