



US00D531774S

(12) **United States Design Patent**
Grossi

(10) **Patent No.:** **US D531,774 S**

(45) **Date of Patent:** **** Nov. 7, 2006**

- (54) **COMBINED TRAVEL STEAM IRON WITH BRUSH OR SIMILAR ARTICLE**
- (75) Inventor: **Andrea Grossi**, Esanatoglia (IT)
- (73) Assignee: **Euro Marketing 90 S.R.L.**, Esanatoglia (IT)
- (**) Term: **14 Years**
- (21) Appl. No.: **29/218,763**
- (22) Filed: **Dec. 7, 2004**
- (51) **LOC (8) Cl.** **07-05**
- (52) **U.S. Cl.** **D32/70; D32/71**
- (58) **Field of Classification Search** D32/68-72; 38/69, 77.1-77.9, 74-75, 77.81, 90-97; 219/245-248
See application file for complete search history.

(56) **References Cited**

U.S. PATENT DOCUMENTS

- 4,366,367 A * 12/1982 Mazzucco 392/335
- D284,798 S * 7/1986 Doyel D32/69
- 4,688,340 A * 8/1987 Ostrelch 38/90
- D301,074 S * 5/1989 Terraillon D32/70
- D340,330 S * 10/1993 Seguljic D32/70
- D360,509 S * 7/1995 Maeda et al. D32/70

D416,655 S * 11/1999 Lin D32/70

* cited by examiner

Primary Examiner—Pamela J. Burgess
(74) *Attorney, Agent, or Firm*—Armstrong, Kratz, Qunitos, Hanson & Brooks, LLP

(57) **CLAIM**

I claim the ornamental design for a combined travel steam iron with brush or similar article, as shown and described.

DESCRIPTION

FIG. 1 is a top perspective view of a combined travel steam iron with brush or similar article, showing my new design; FIG. 2 is a left side elevational view thereof; FIG. 3 is a right side elevational view thereof; FIG. 4 is a top plan view thereof; FIG. 5 is a bottom plan view thereof; FIG. 6 is a front elevational view thereof; FIG. 7 is a rear elevational view thereof; FIG. 8 is a top plan view thereof, in an alternate position, with the handle pivotally turned outwardly; FIG. 9 is a top plan view thereof, with the handle removed for clarity of disclosure; FIG. 10 is a bottom plan view of the handle thereof, shown separately for clarity of disclosure; and, FIG. 11 is a bottom perspective view thereof, with a brush attached thereto.

1 Claim, 4 Drawing Sheets

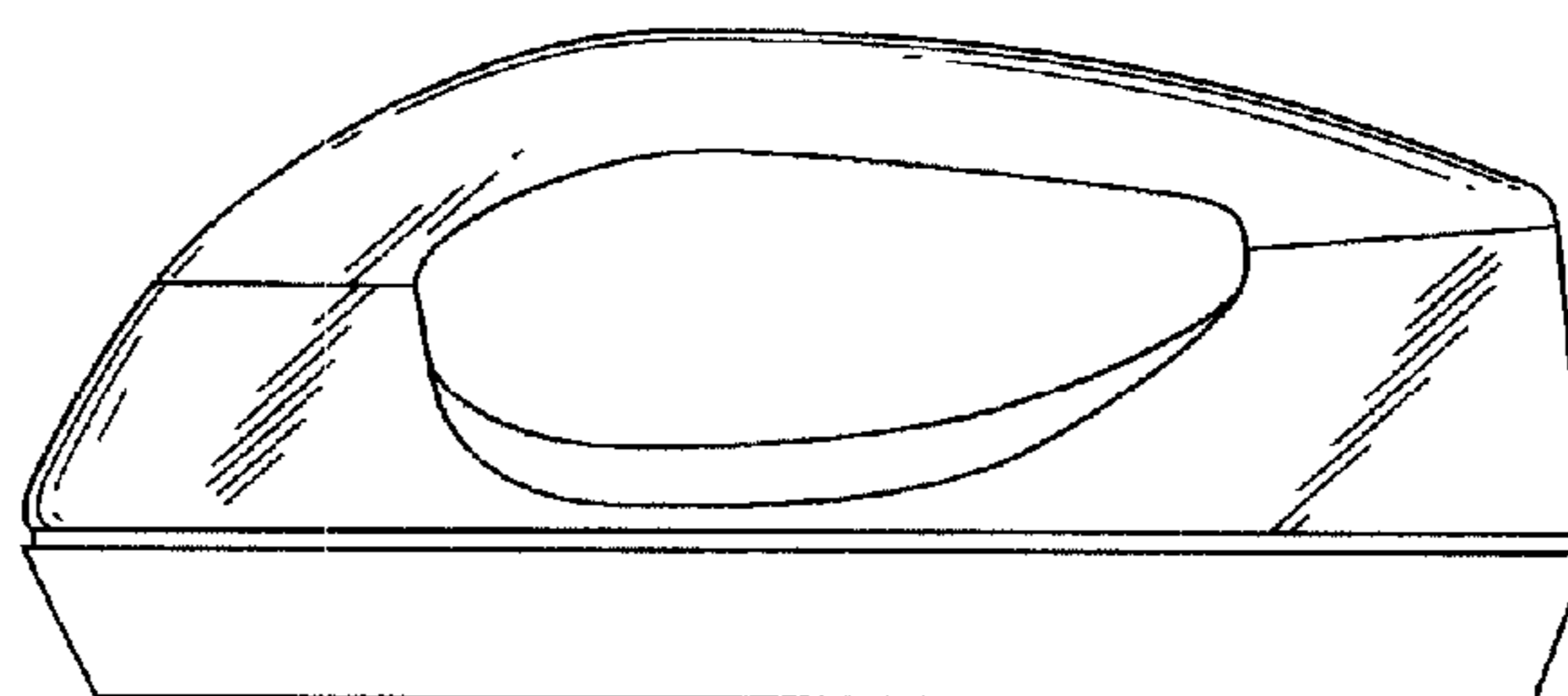
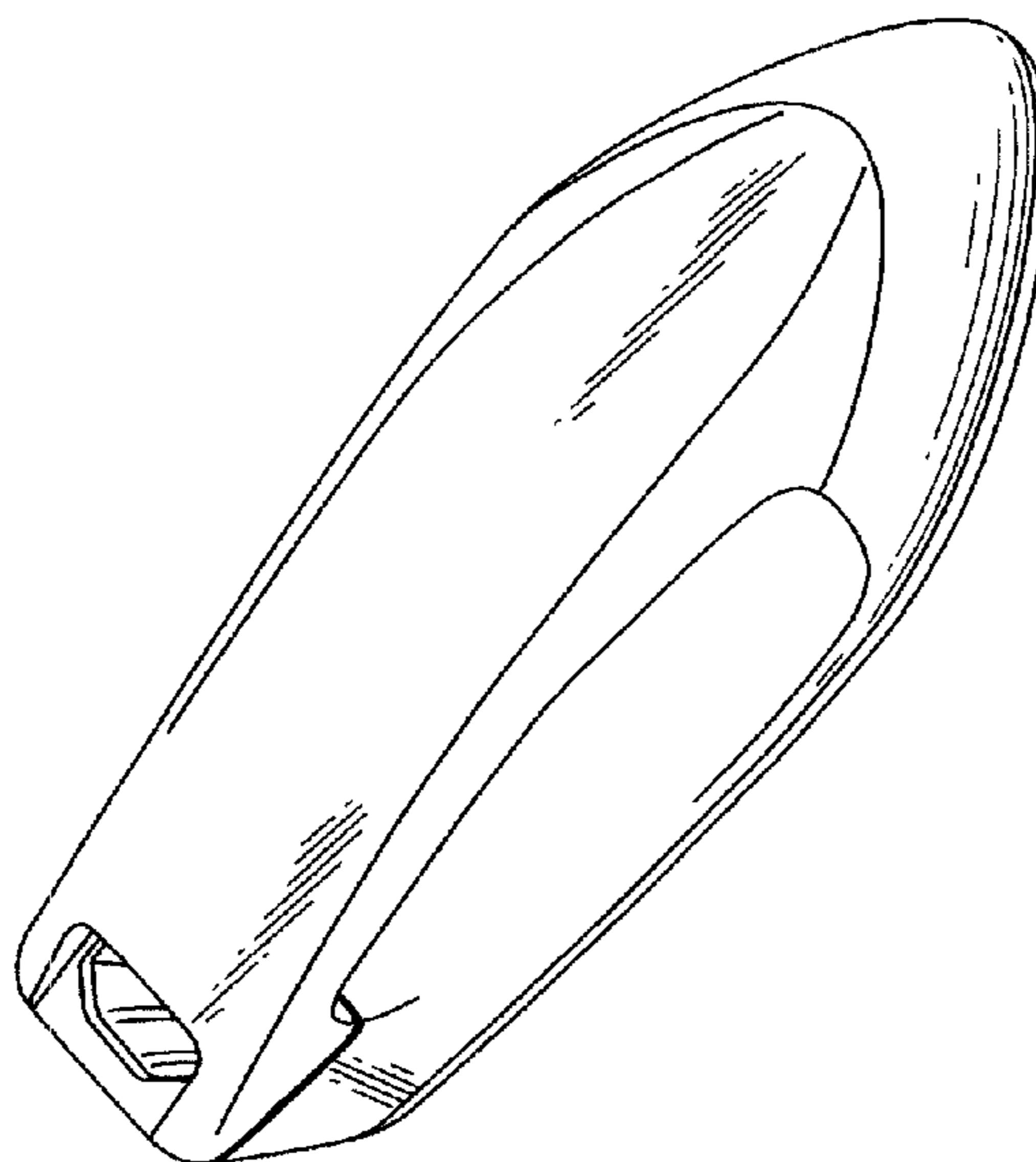

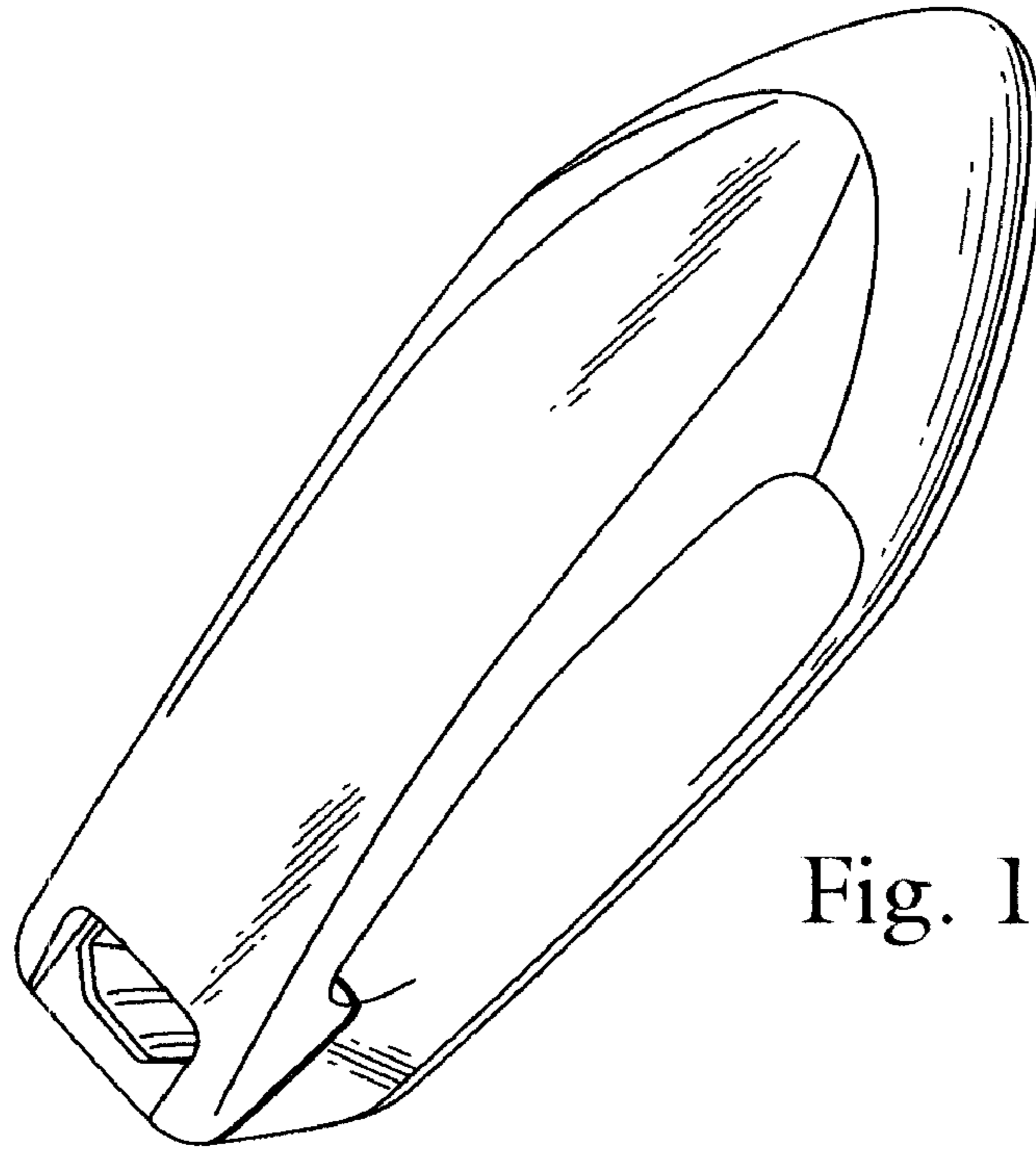

Fig. 1

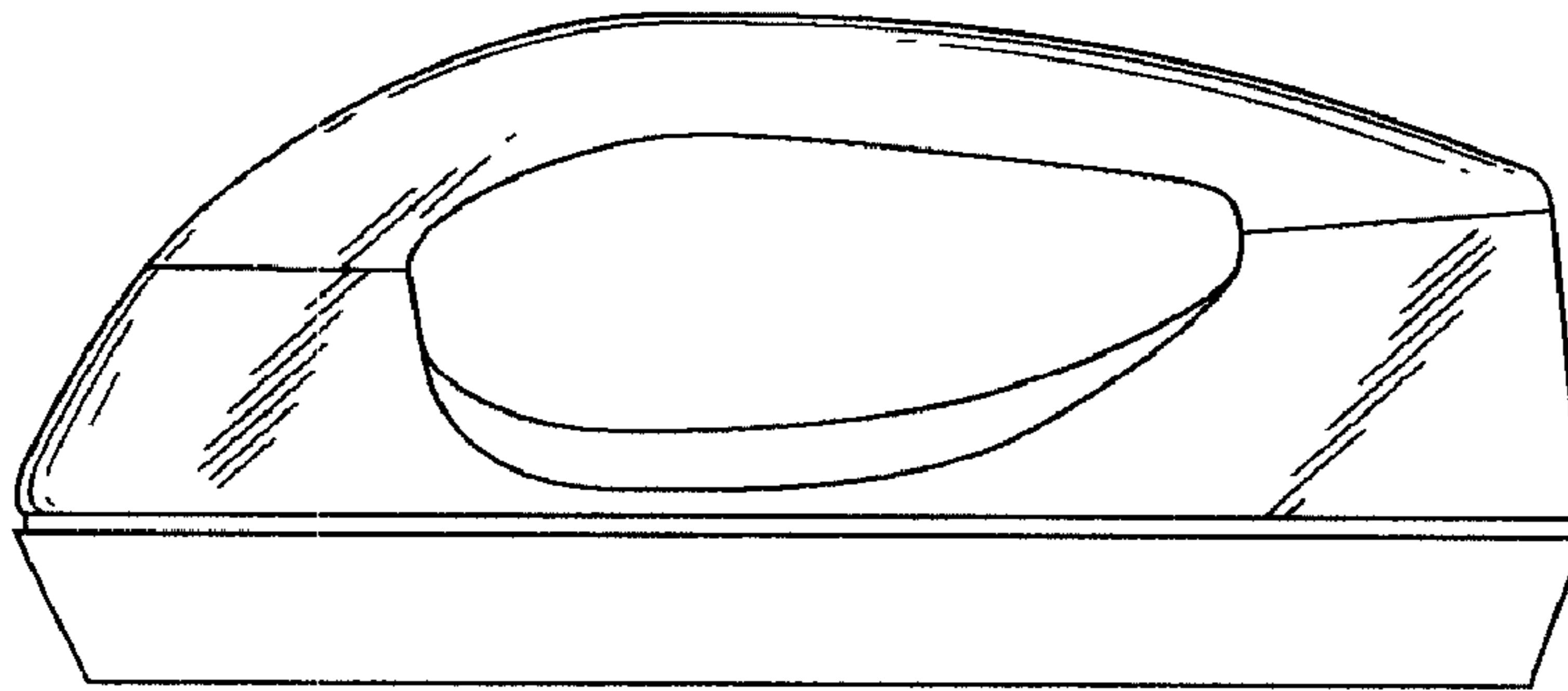
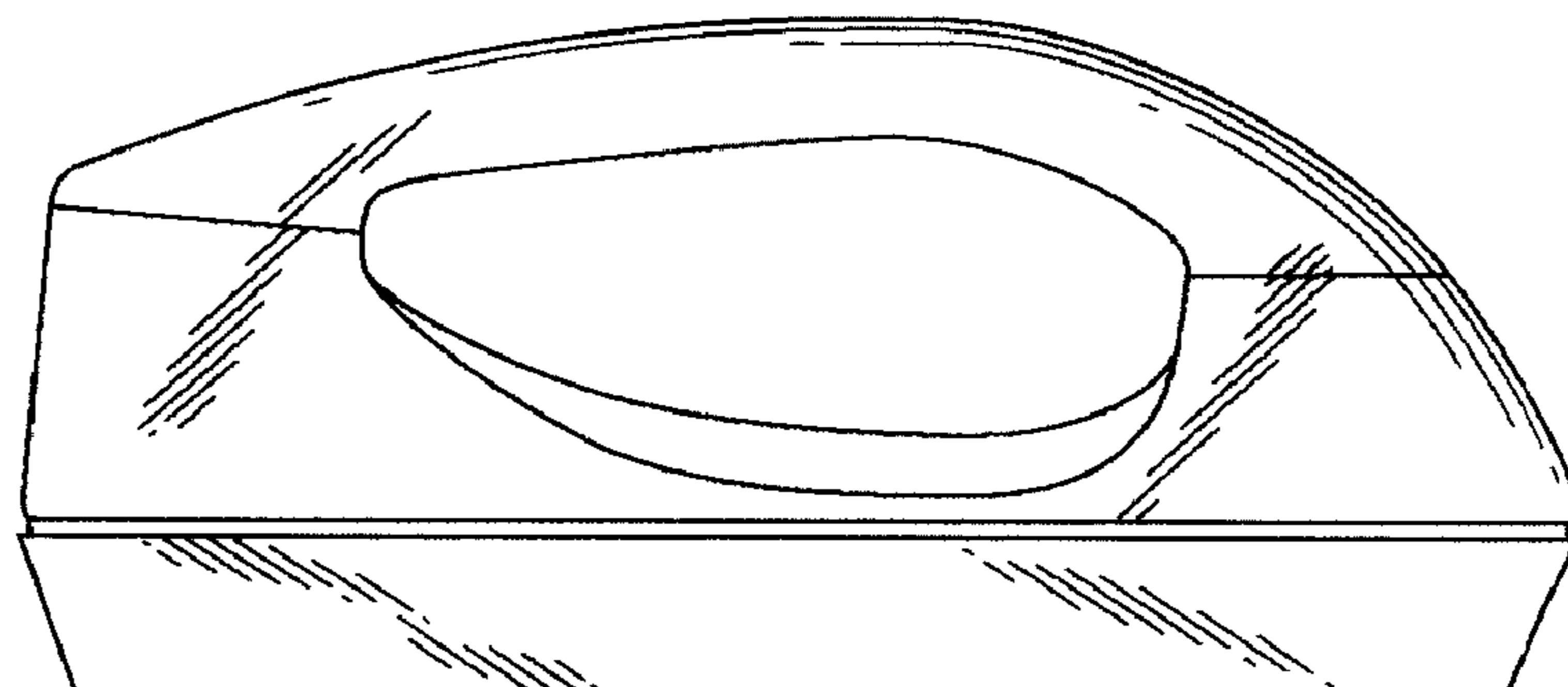

Fig. 2

Fig. 3



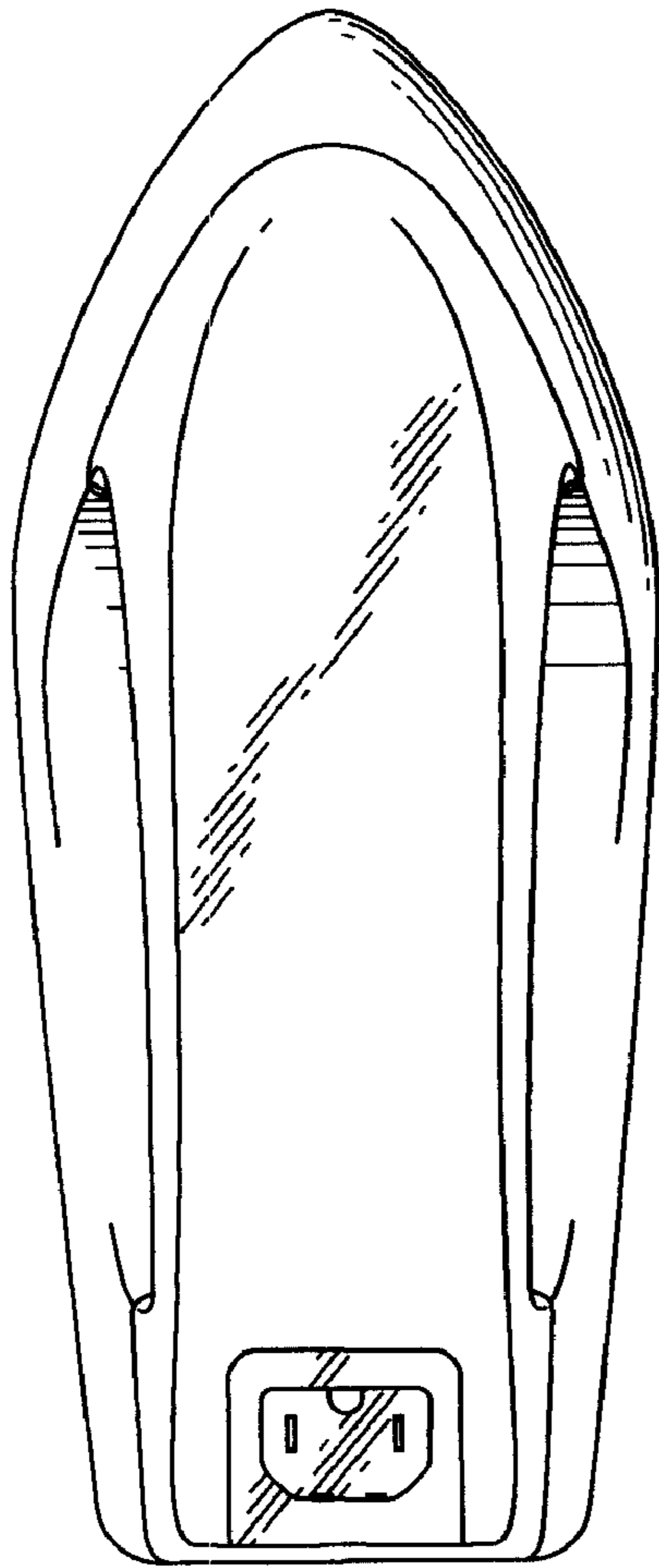

Fig. 4

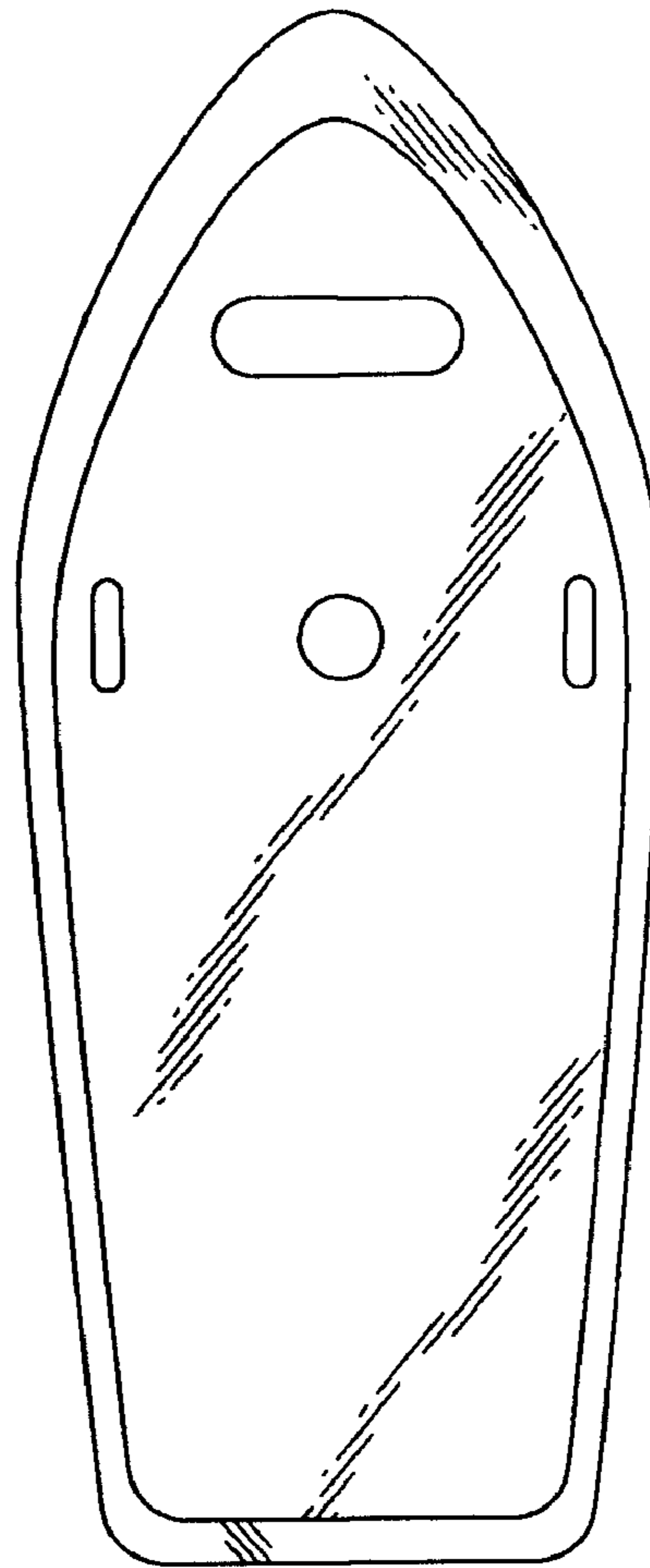

Fig. 5

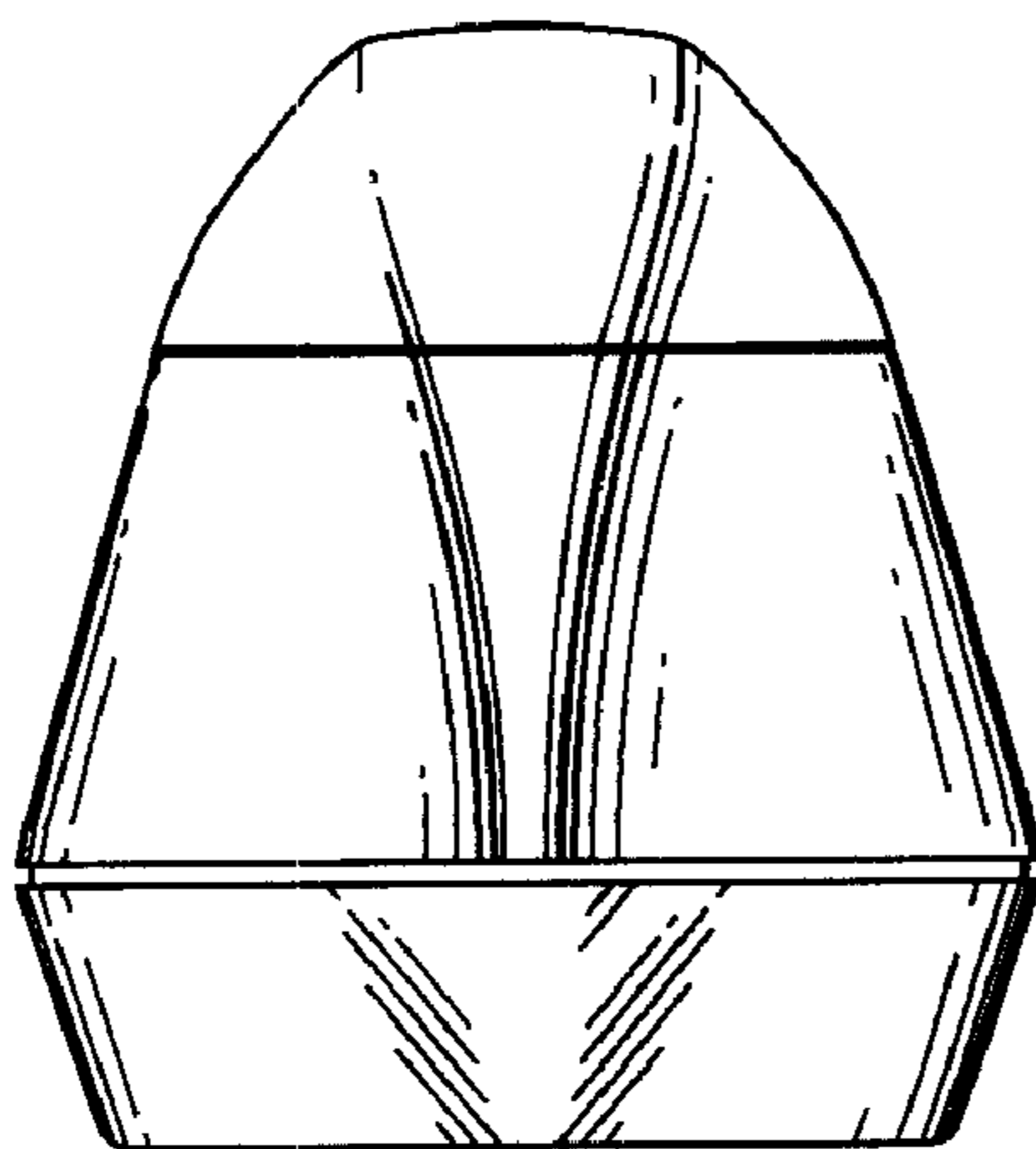

Fig. 6

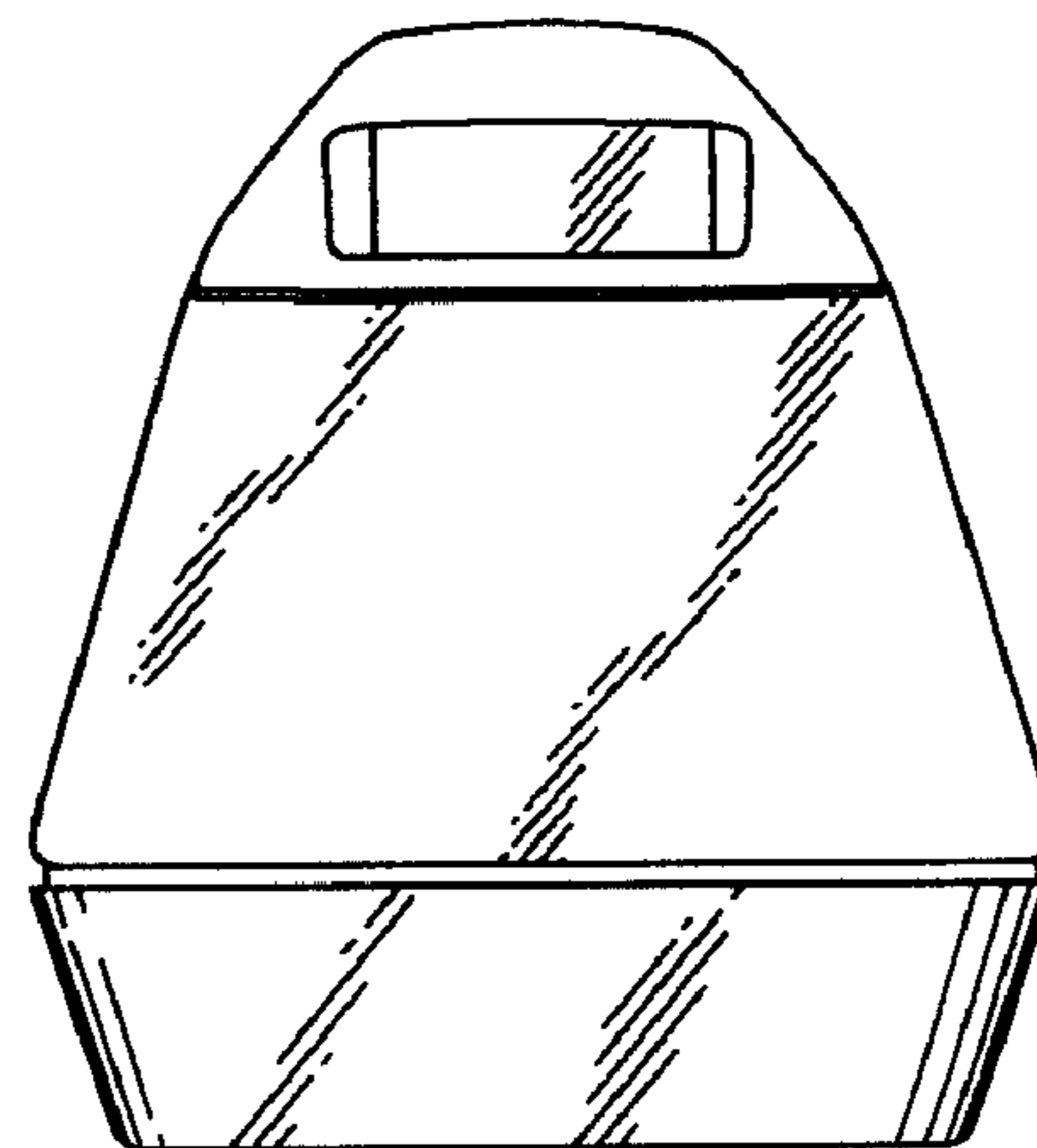

Fig. 7

Fig. 8

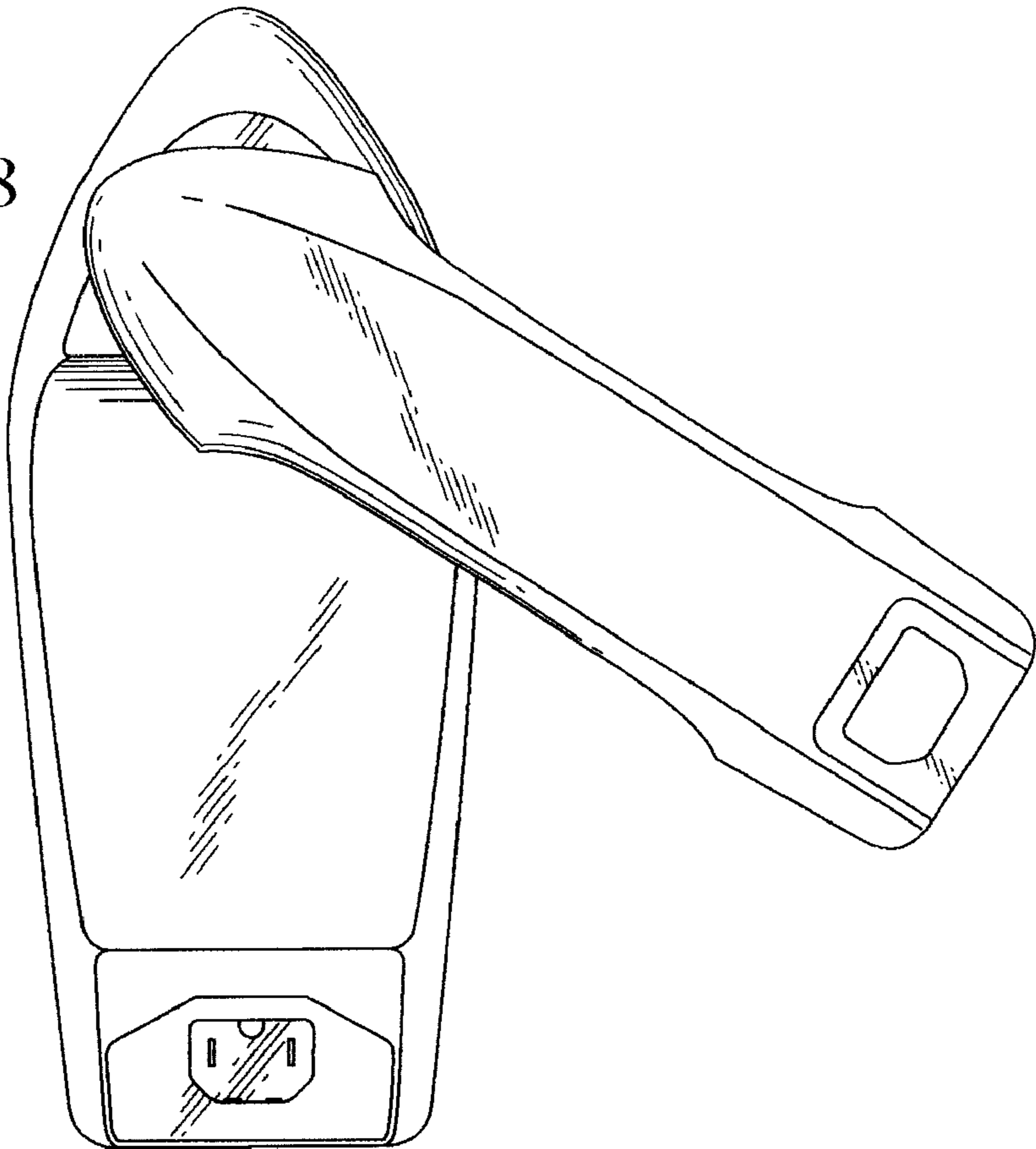

Fig. 9

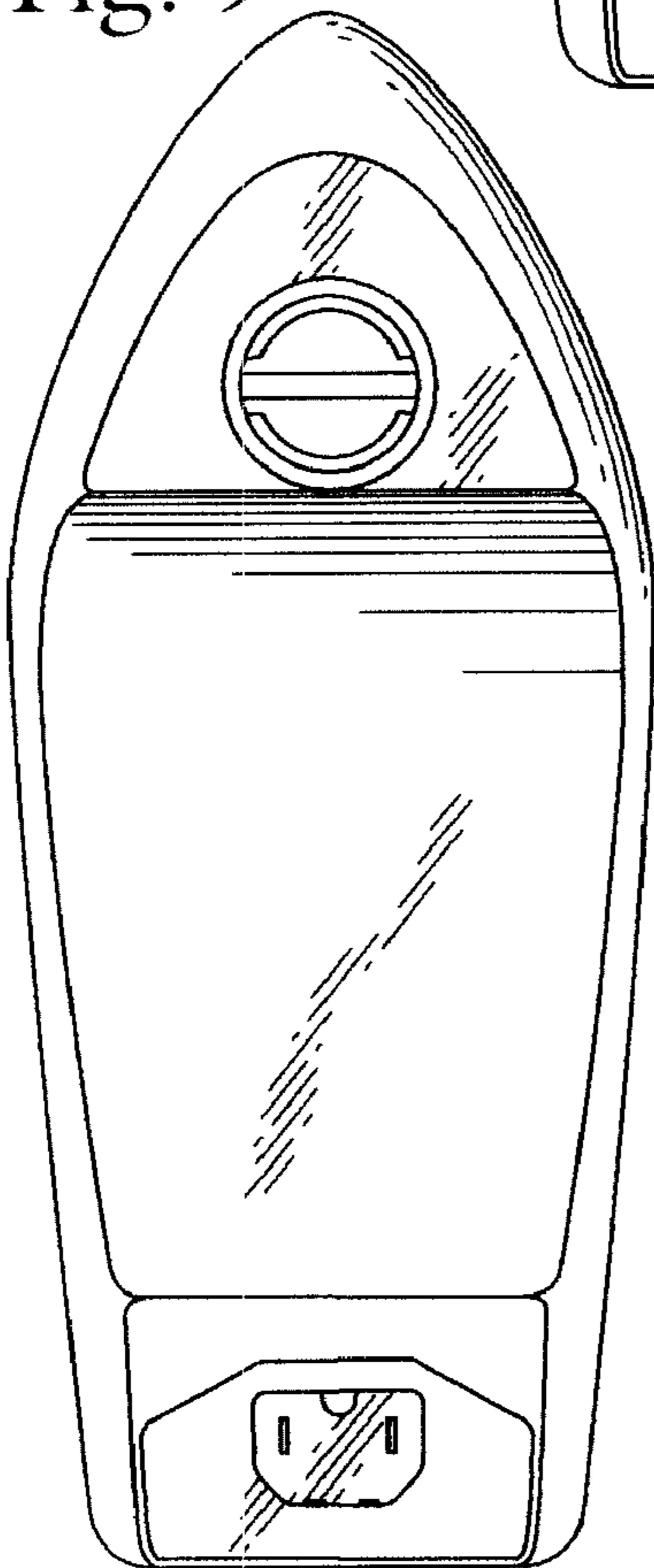
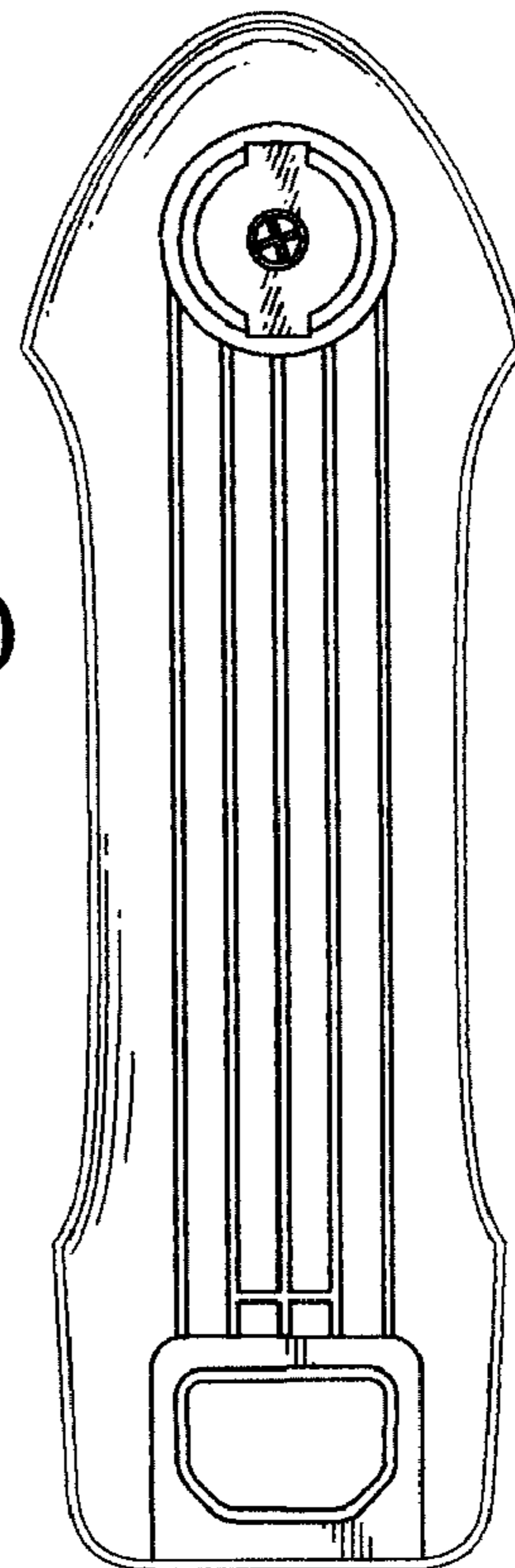

Fig. 10



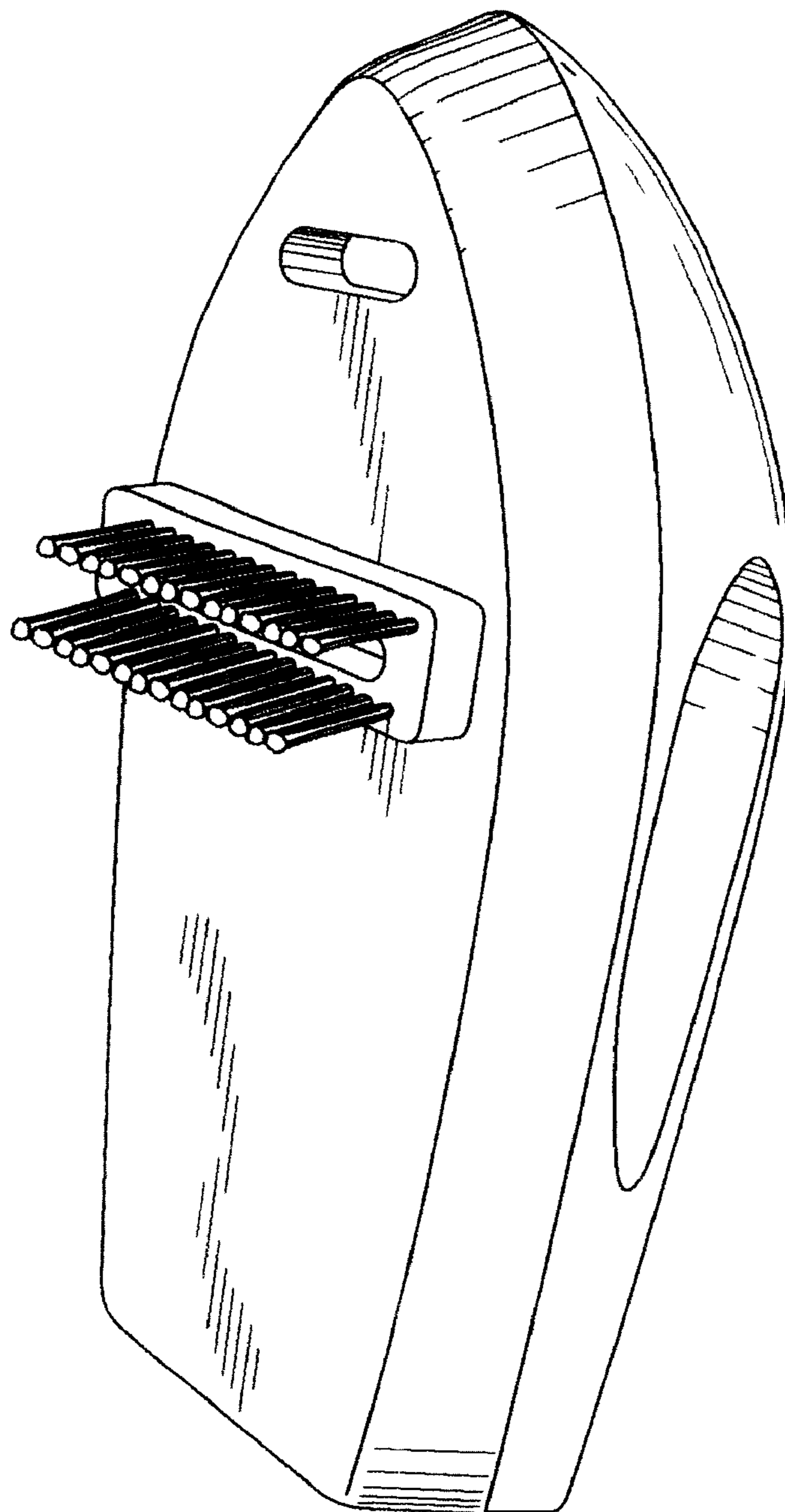

Fig. 11