



US00D531700S

(12) **United States Design Patent**
Svendsen et al.

(10) **Patent No.:** **US D531,700 S**

(45) **Date of Patent:** **** Nov. 7, 2006**

(54) **DUAL HANDLE CENTERSET FAUCET**

(75) Inventors: **Sean W. Svendsen**, Columbus, OH (US); **Christopher P. Marks**, Groveport, OH (US); **Joseph M. Lehman**, New Albany, OH (US); **Michael J. Krull**, Hilliard, OH (US); **Michael J. Painter**, Reynoldsburg, OH (US); **Heather T. Loge**, Westerville, OH (US)

(73) Assignee: **American Standard International Inc.**, New York, NY (US)

(**) Term: **14 Years**

(21) Appl. No.: **29/252,510**

(22) Filed: **Jan. 23, 2006**

(51) **LOC (8) Cl.** **23-01**

(52) **U.S. Cl.** **D23/241; D23/242**

(58) **Field of Classification Search** **D23/238-257; 4/675-678; 137/801**

See application file for complete search history.

(56) **References Cited**

U.S. PATENT DOCUMENTS

D443,031 S * 5/2001 Strader et al. D23/241

D463,010 S * 9/2002 Ouyoung D23/241
D513,789 S * 1/2006 Kosasih D23/241
D516,675 S * 3/2006 Kakihana D23/241
D518,558 S * 4/2006 Soriano D23/255

* cited by examiner

Primary Examiner—Louis S. Zarfes
Assistant Examiner—Gregory Andoll

(57) **CLAIM**

The ornamental design for a dual handle centerset faucet, as shown.

DESCRIPTION

FIG. 1 is a front perspective view of a preferred embodiment of a dual handle centerset faucet showing our new design; FIG. 2 is a top view; FIG. 3 is a front view; FIG. 4 is a left side view; FIG. 5 is a right side view; FIG. 6 is a rear view; and, FIG. 7 is a bottom view.

The broken lines in the figures are for illustrative purposes only and form no part of the claimed design.

1 Claim, 7 Drawing Sheets



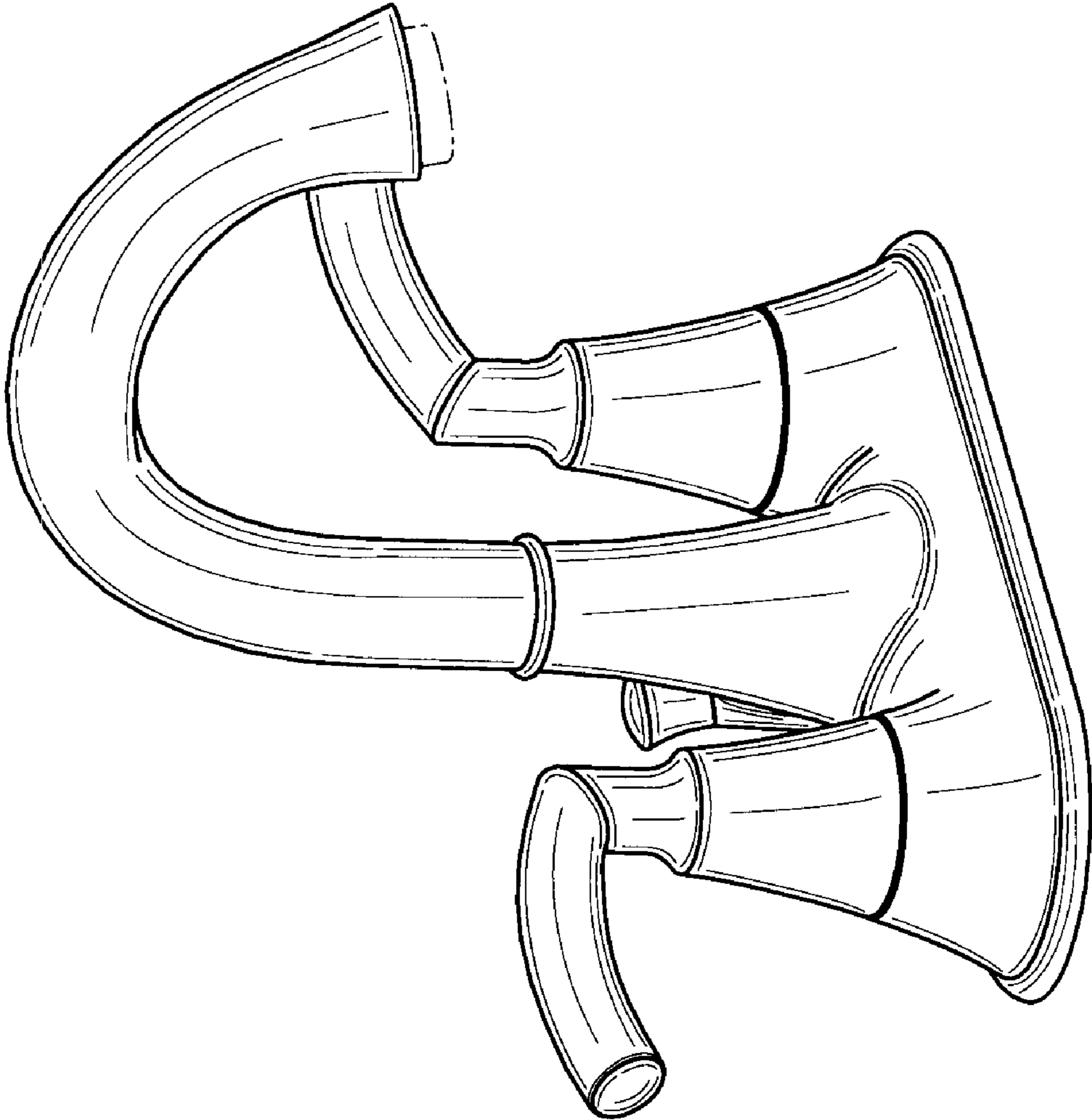

FIG. 1

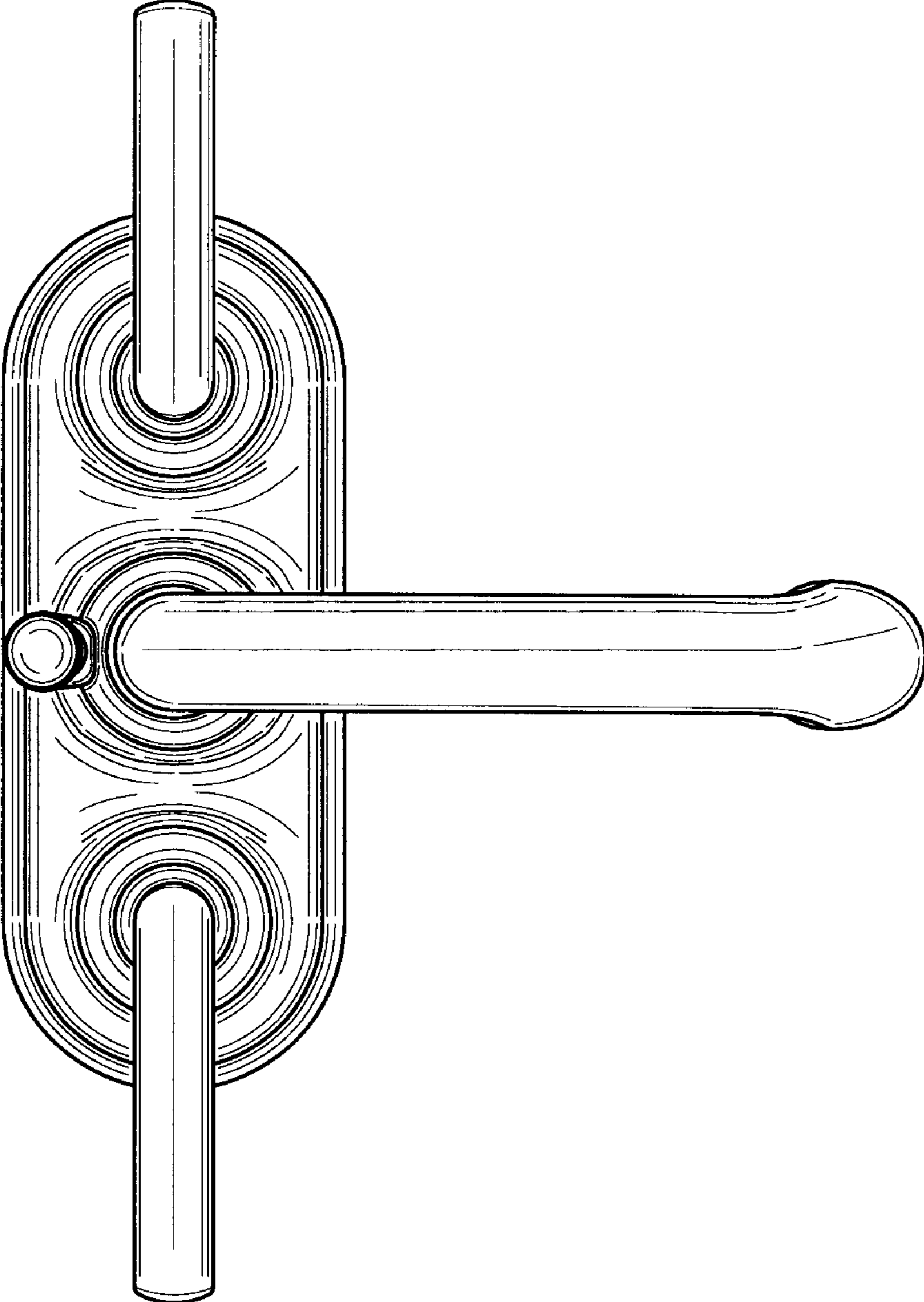

FIG. 2

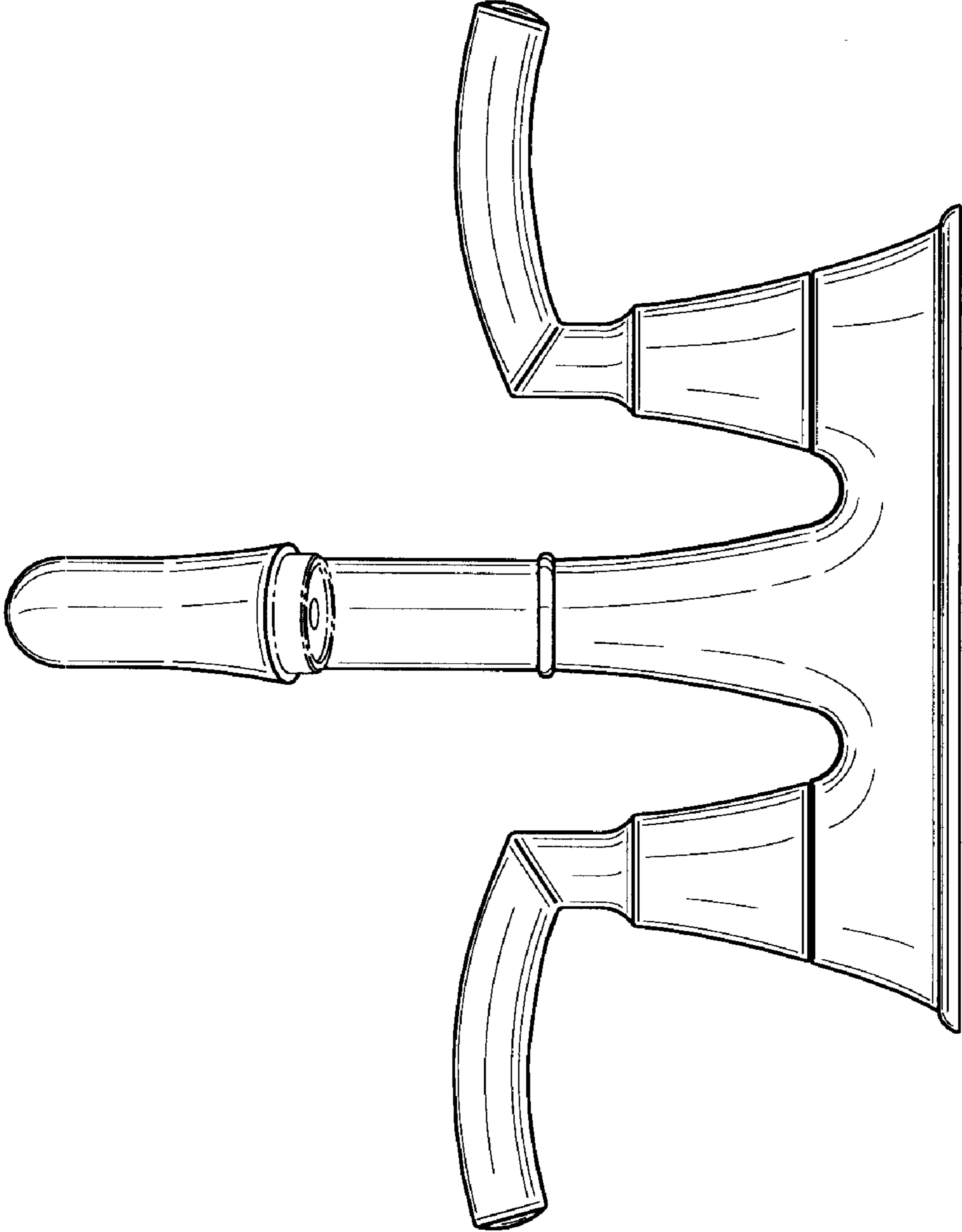

FIG. 3

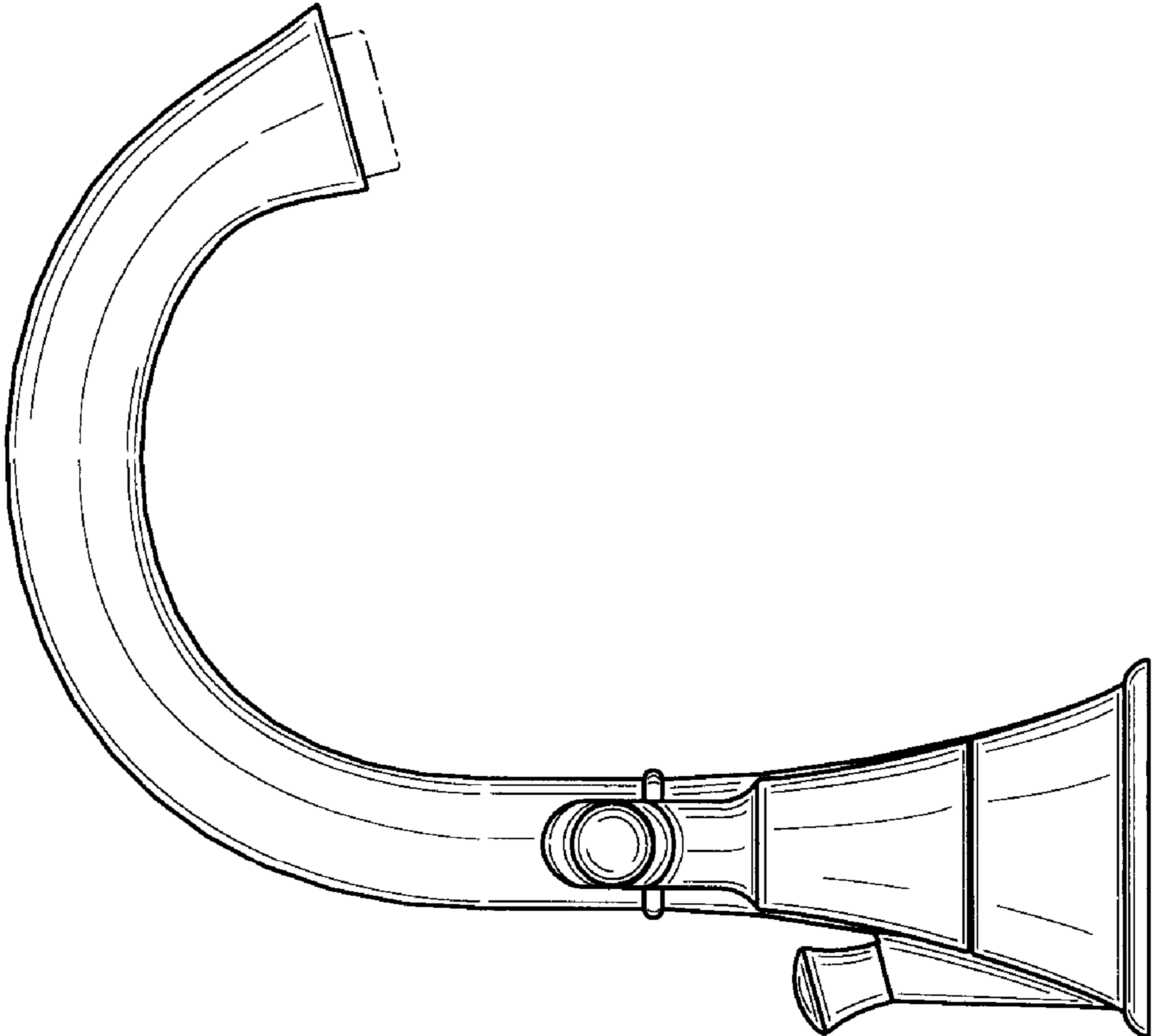

FIG. 4

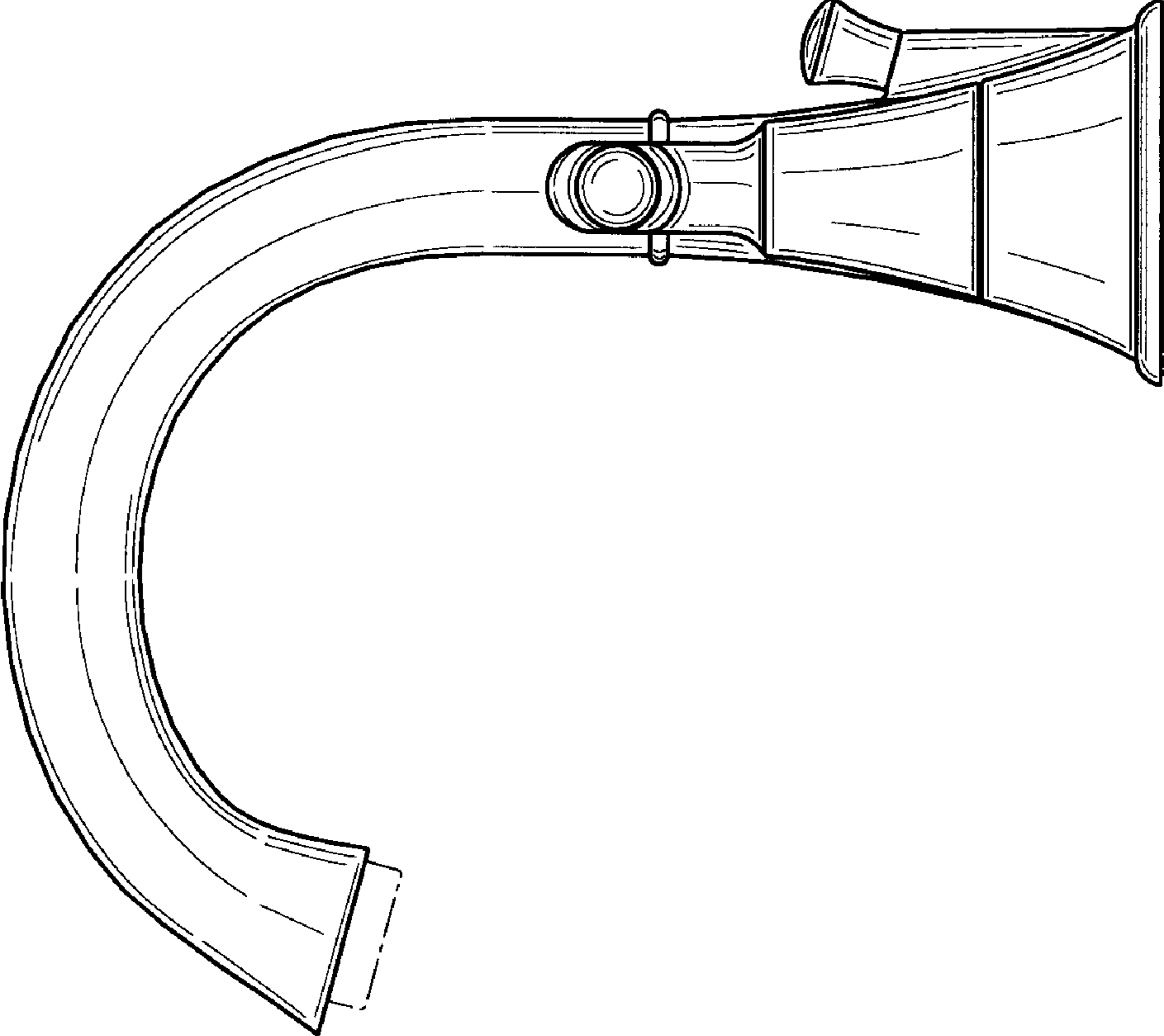

FIG. 5

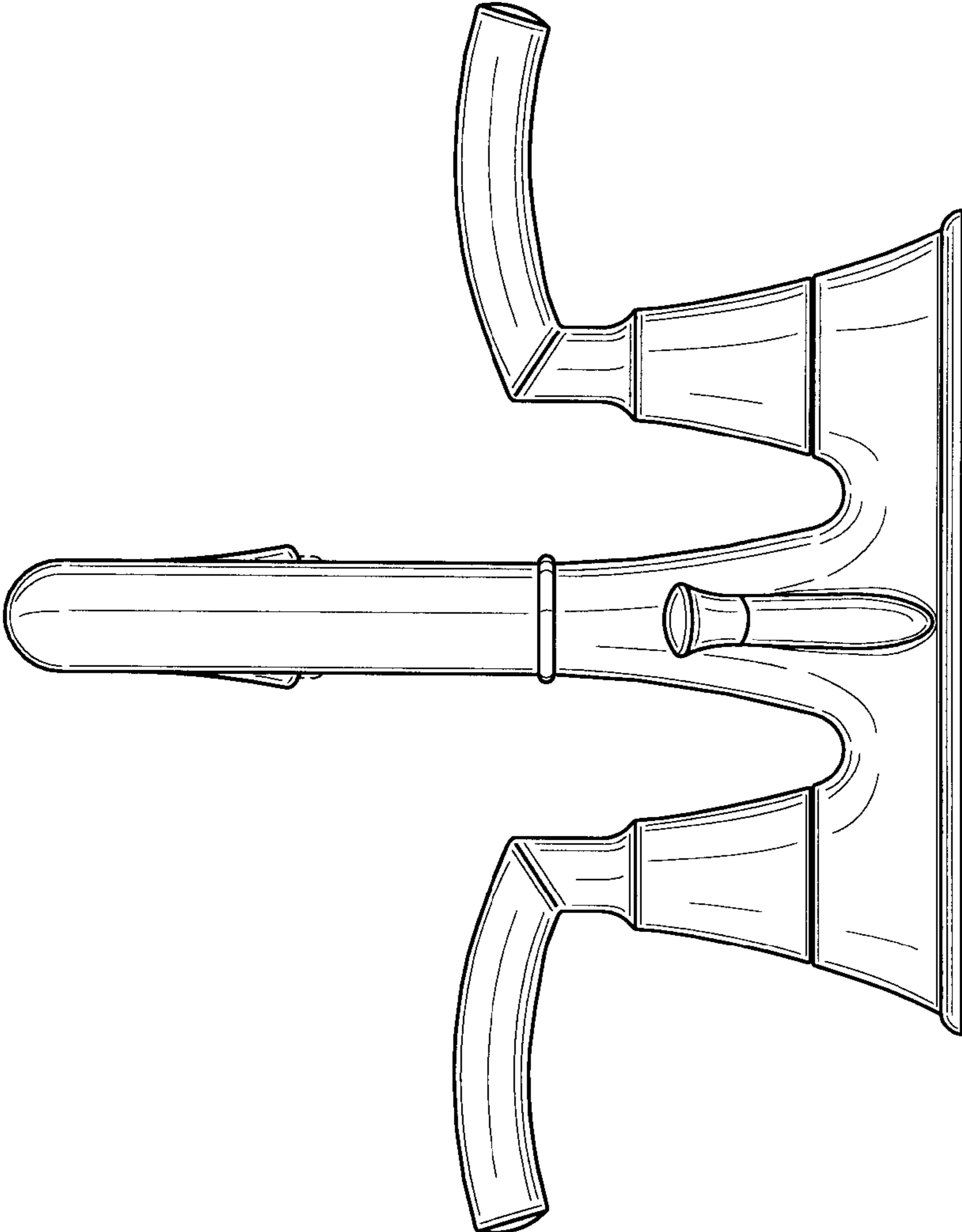

FIG. 6

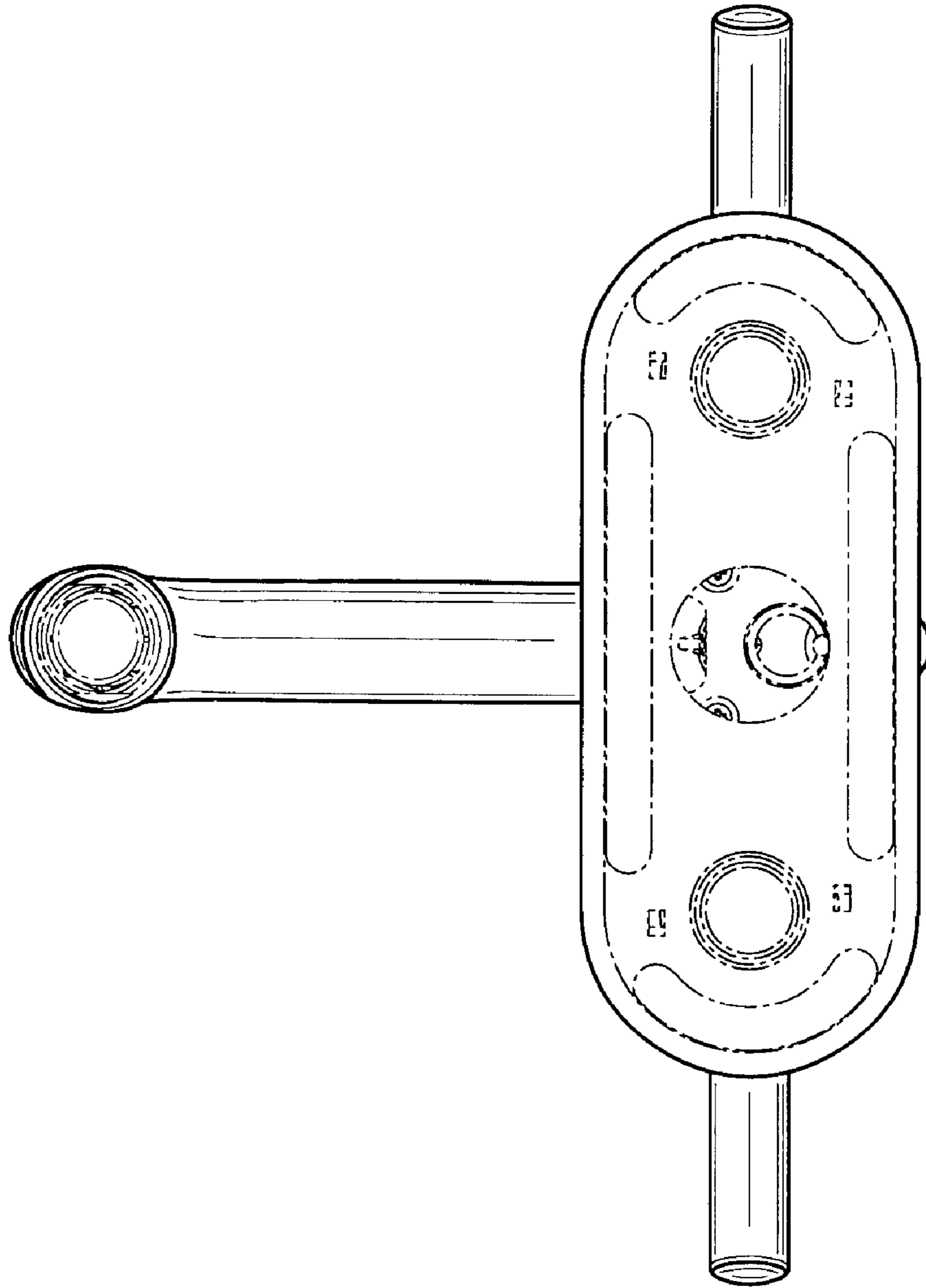

FIG. 7