



US00D531659S

(12) **United States Design Patent** (10) **Patent No.:** **US D531,659 S**  
**Lo** (45) **Date of Patent:** **\*\* Nov. 7, 2006**

(54) **PAPER SHREDDER**

(76) Inventor: **Emily Lo**, No. 18, Lane 20, Hsin Feng Street, Hsin Chuang City, Taipei Shien (TW)

(\*\*) Term: **14 Years**

(21) Appl. No.: **29/230,208**

(22) Filed: **May 18, 2005**

(51) **LOC (8) Cl.** ..... **18-04**

(52) **U.S. Cl.** ..... **D18/34.5**

(58) **Field of Classification Search** ..... D18/34.1-34.9, D18/99, 50; 83/167, 289, 302, 203, 523, 83/633; 241/169.1, 36, 154, 157, 222, 224, 241/168, 284, 295, 37.5, 285.1, 2, 100, 236; D8/99; D7/381, 383  
See application file for complete search history.

(56) **References Cited**

**U.S. PATENT DOCUMENTS**

D410,246 S \* 5/1999 Holderfield ..... D18/34.6  
D410,946 S \* 6/1999 Holderfield ..... D18/34.5  
6,164,573 A \* 12/2000 Li-Ming ..... 241/236  
D454,907 S \* 3/2002 Ho ..... D18/34.6

D498,252 S \* 11/2004 Lo ..... D18/34.6  
D498,253 S \* 11/2004 Lo ..... D18/34.6  
D502,729 S \* 3/2005 Lo ..... D18/34.5  
D502,961 S \* 3/2005 Lo ..... D18/34.6  
7,025,293 B1 \* 4/2006 Matlin et al. .... 241/100  
2005/0072869 A1 \* 4/2005 Ting ..... 241/100  
2005/0121551 A1 \* 6/2005 Ho ..... 241/236

\* cited by examiner

*Primary Examiner*—Charles A. Rademaker

(74) *Attorney, Agent, or Firm*—Pro-Techtor Int’l Services

(57) **CLAIM**

The ornamental design for paper shredder, as shown and described.

**DESCRIPTION**

FIG. 1 is a perspective view of paper shredder showing my new design;  
FIG. 2 is a front elevational view thereof;  
FIG. 3 is a rear elevational view thereof;  
FIG. 4 is a top plan view thereof;  
FIG. 5 is a bottom plan view thereof;  
FIG. 6 is a left side elevational view thereof; and,  
FIG. 7 is a right side elevational view thereof.

**1 Claim, 6 Drawing Sheets**

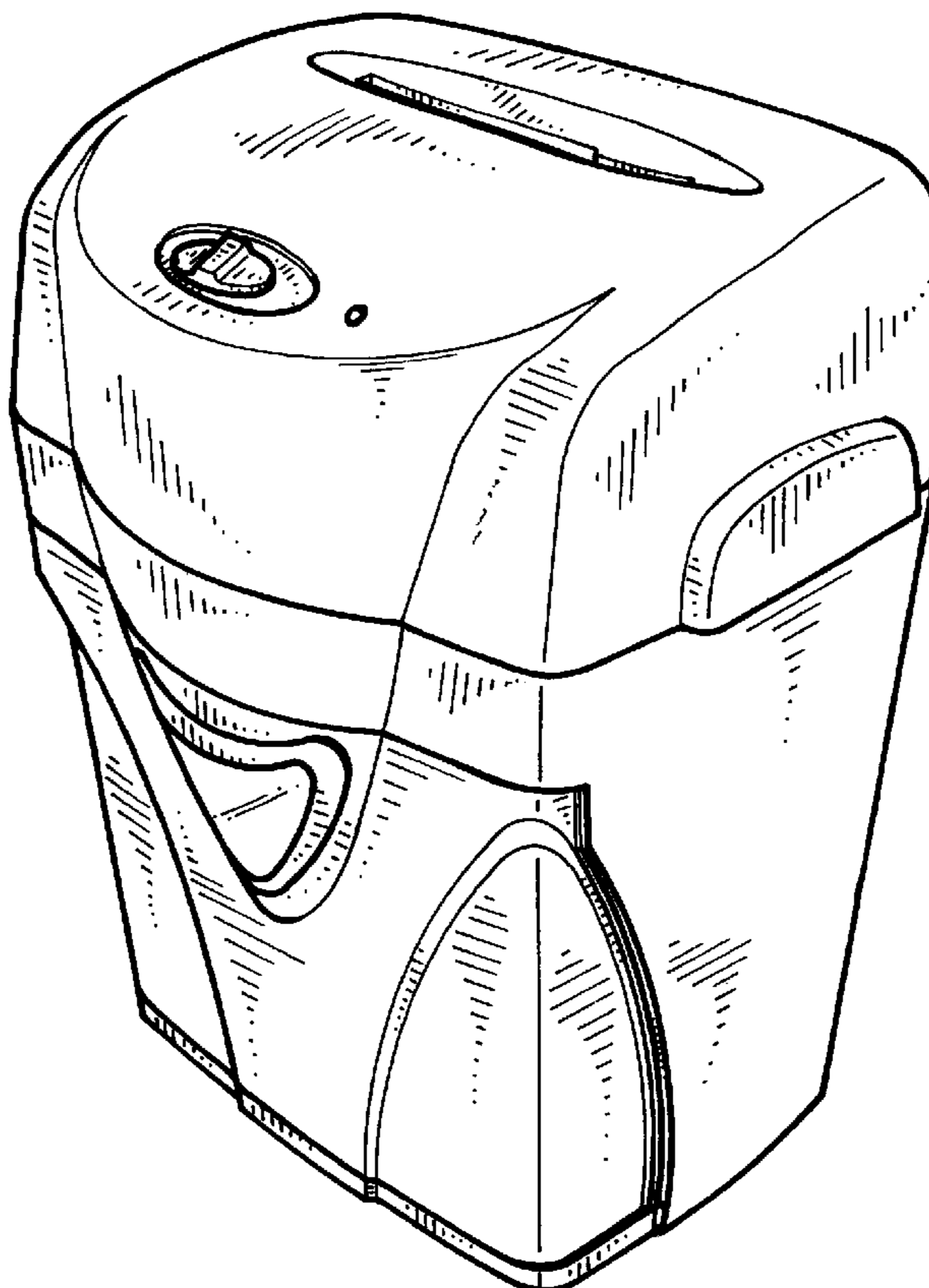

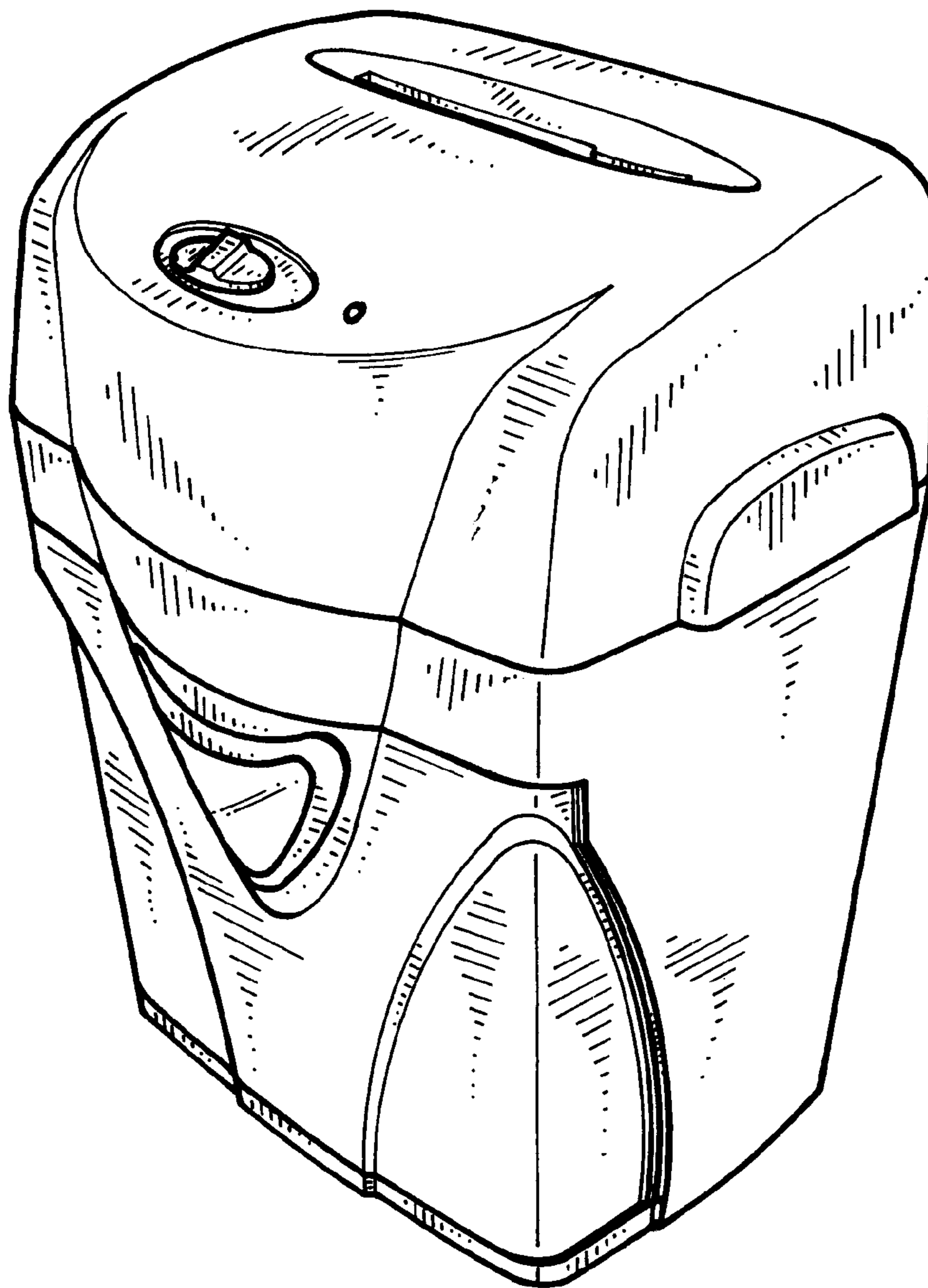

FIG. 1

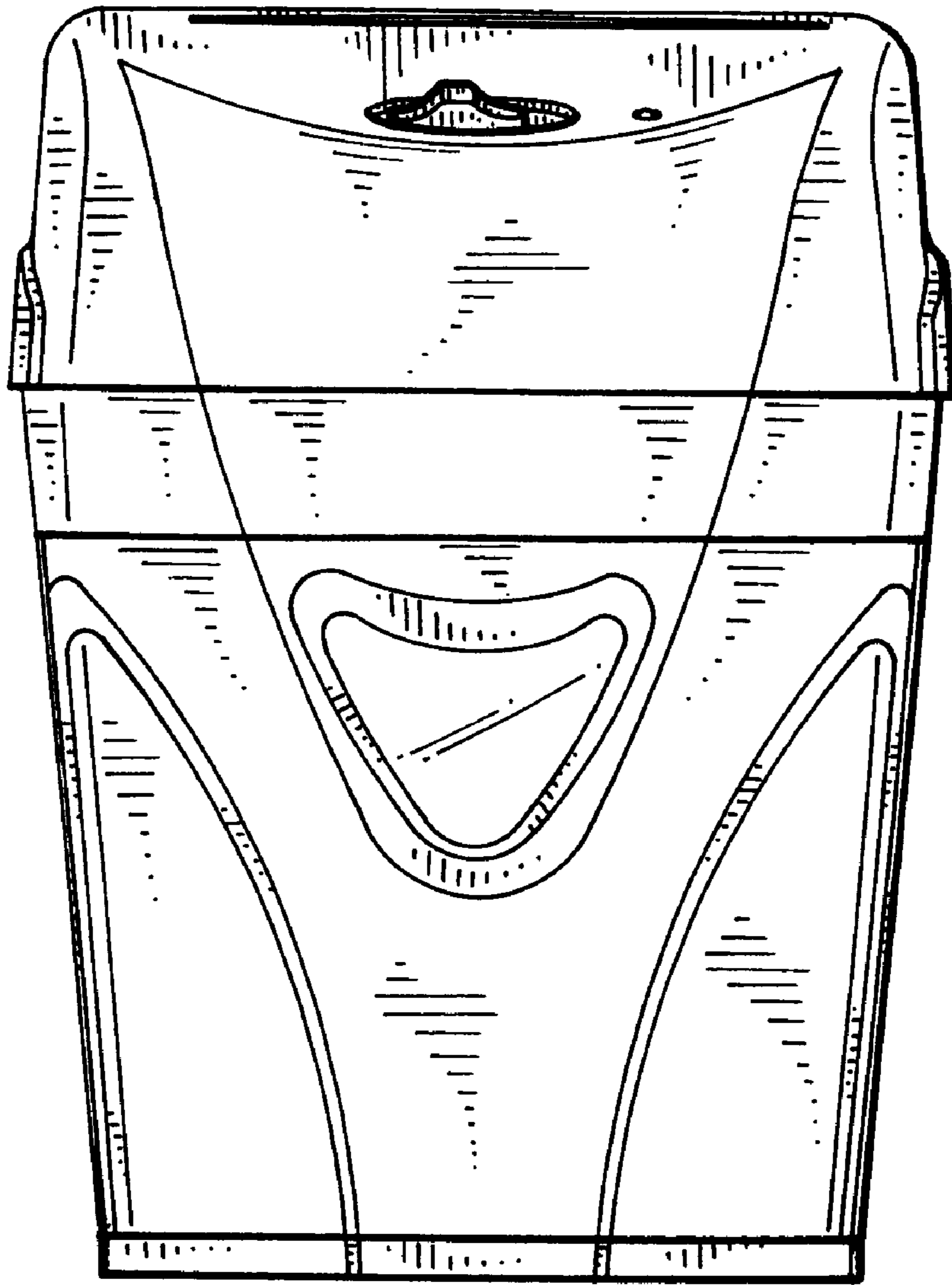

FIG.2

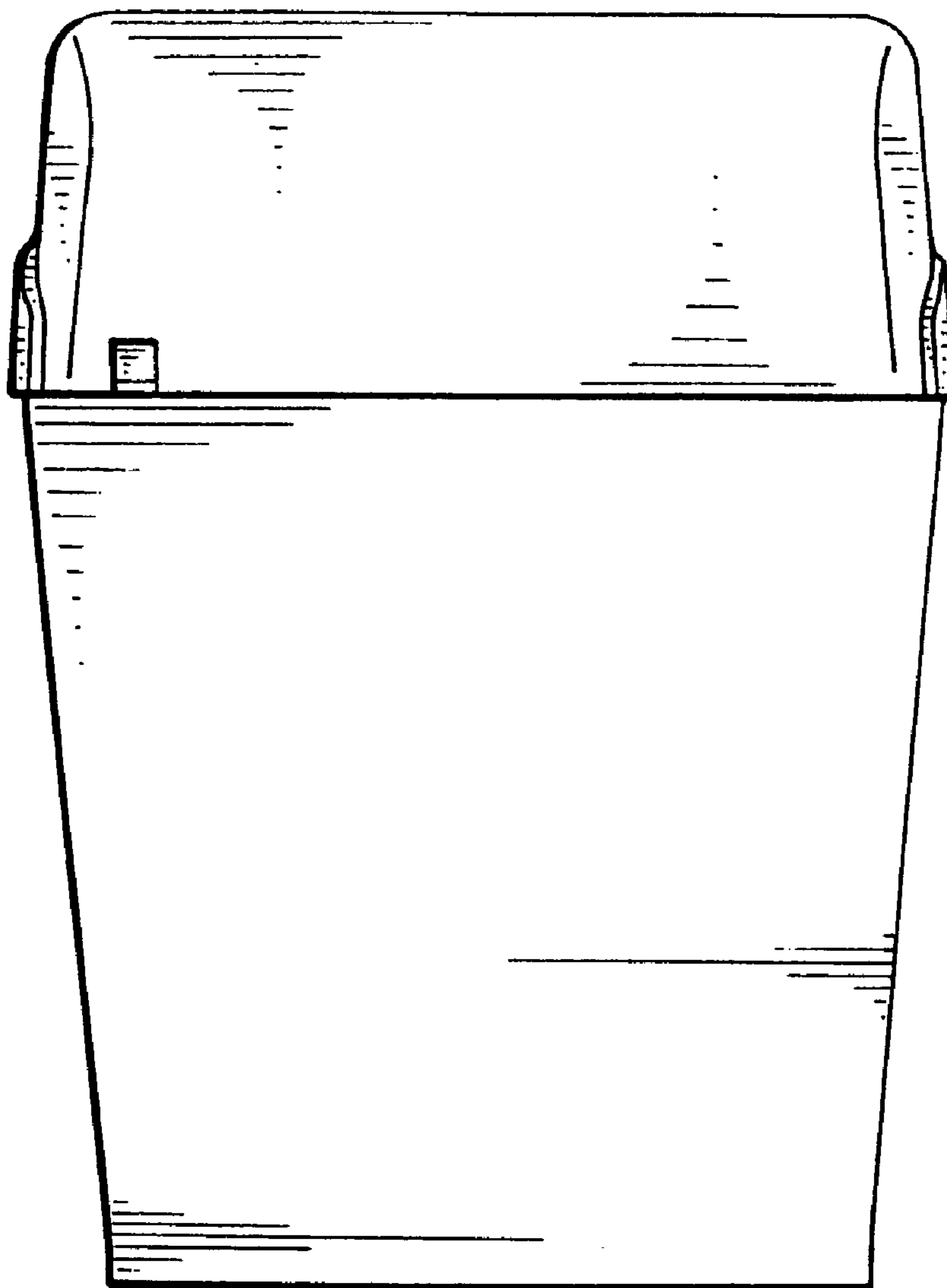

FIG. 3

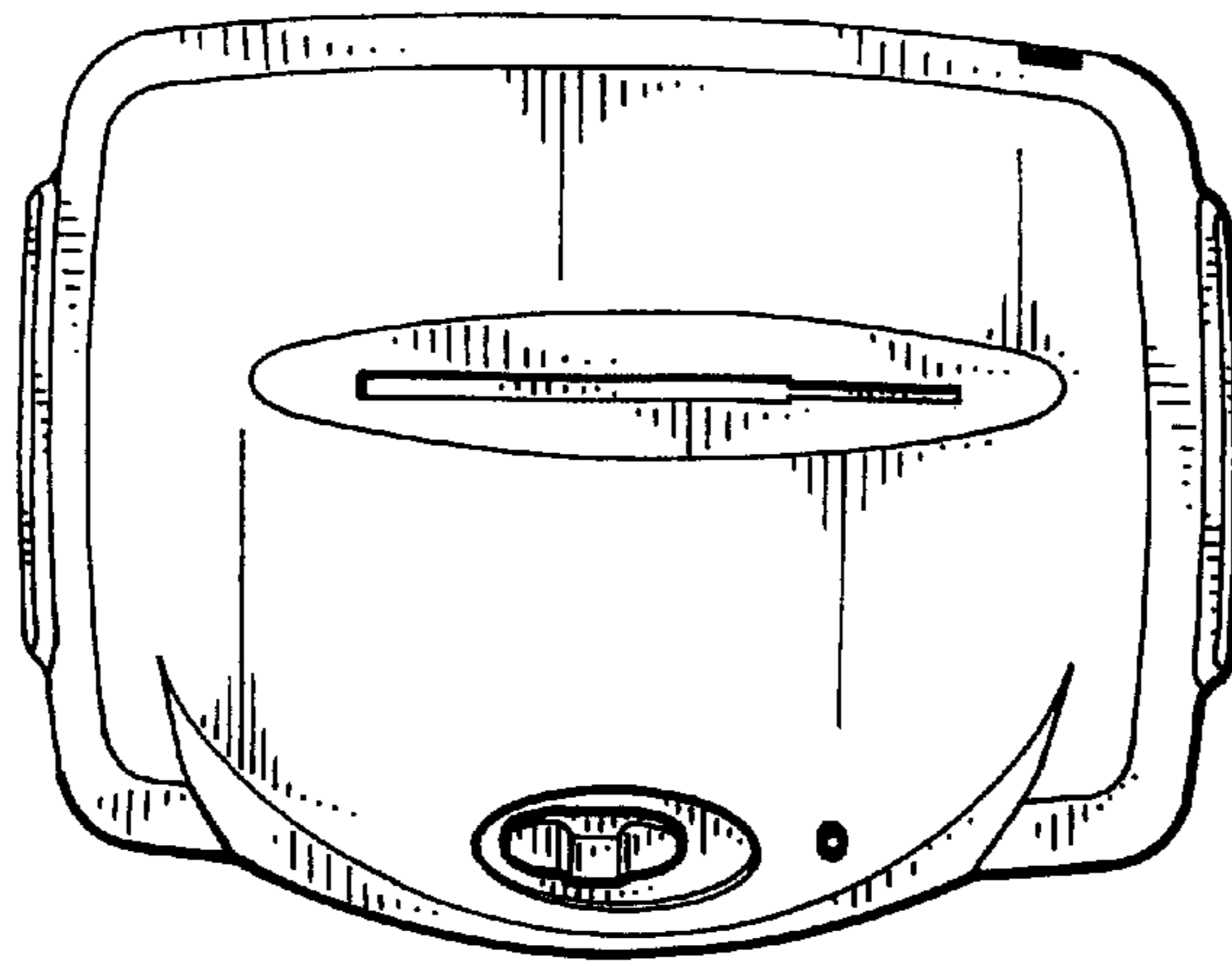

FIG. 4

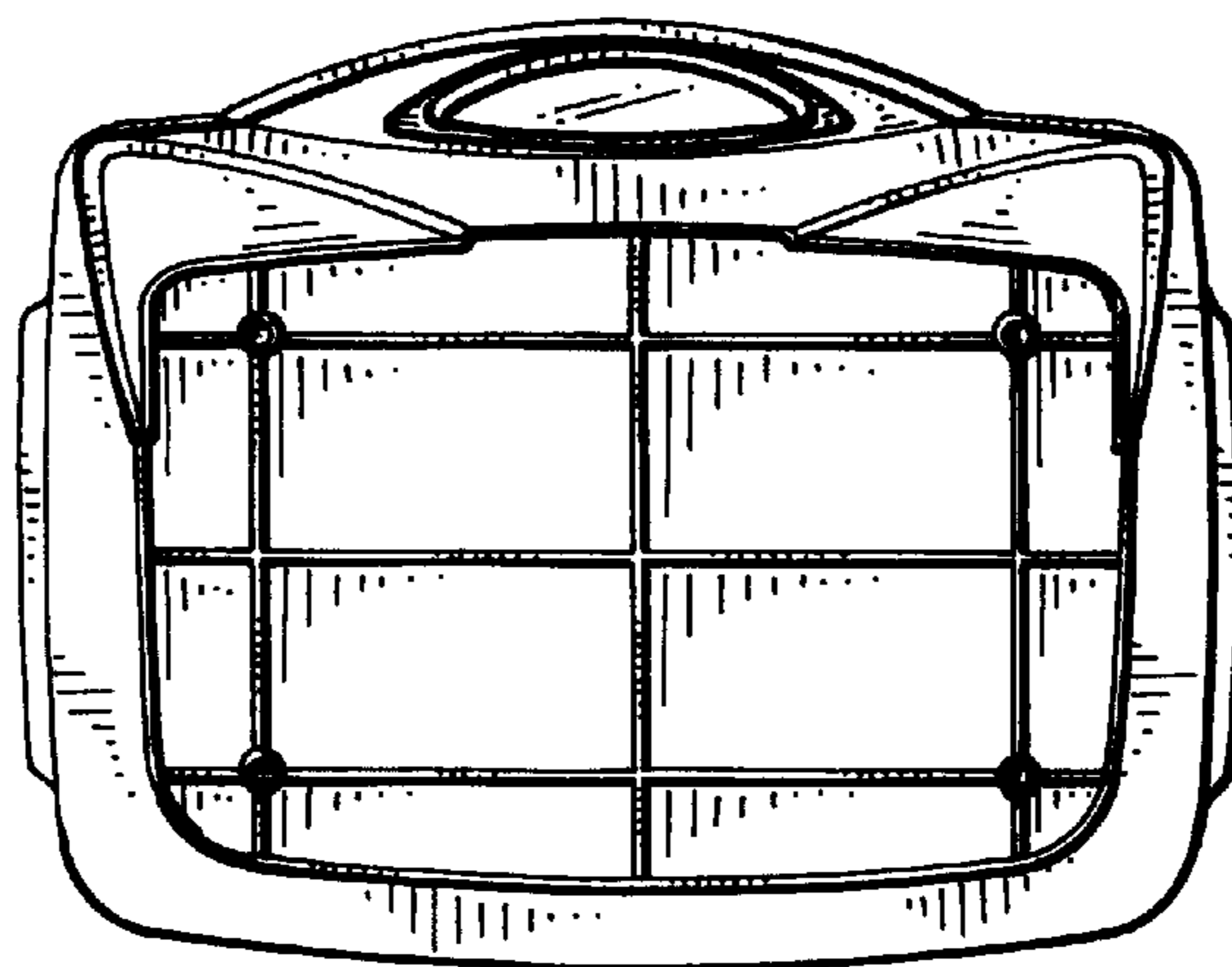

FIG. 5

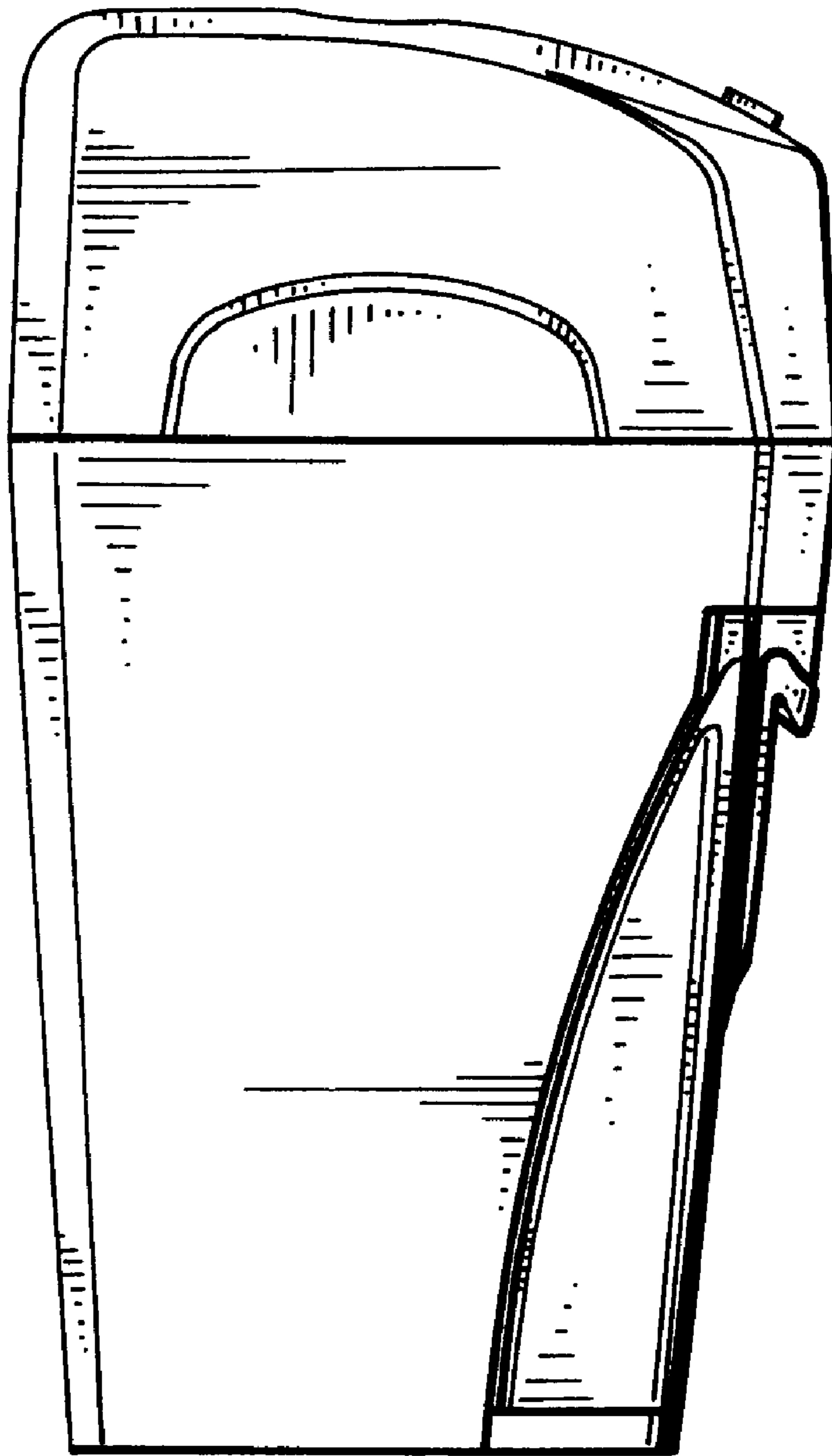

FIG.6

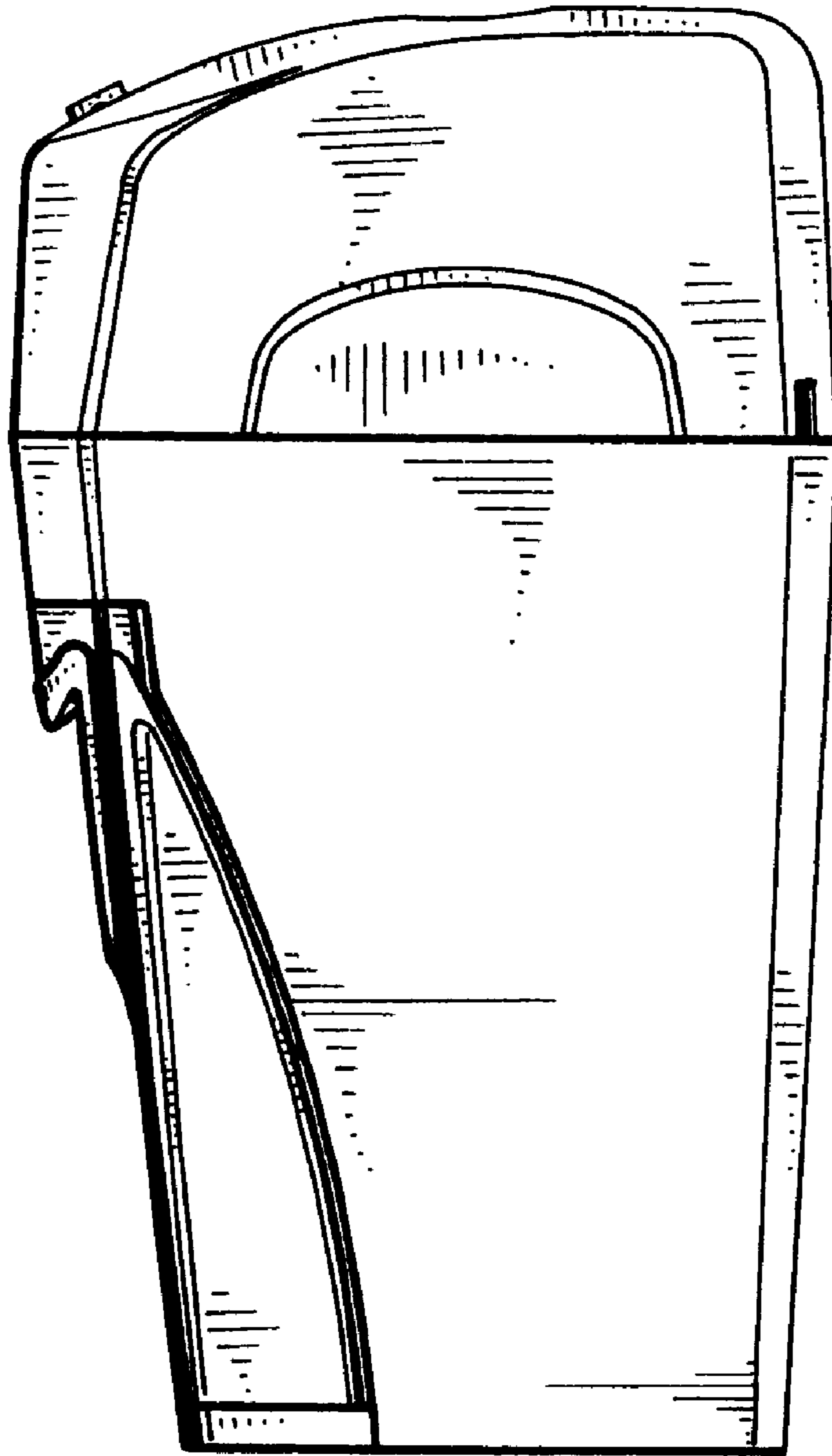

FIG. 7