



US00D531608S

(12) **United States Design Patent**  
**Kim et al.**

(10) **Patent No.:** **US D531,608 S**

(45) **Date of Patent:** **\*\* Nov. 7, 2006**

(54) **PORTABLE PHONE**

(75) Inventors: **Young-Sae Kim**, Palo Alto, CA (US);  
**Chi-Young Ahn**, Seodaemun-Gu (KR);  
**Beom-Ku Han**, Seoul (KR);  
**Chang-Hwan Hwang**, Goyang-Si (KR)

(73) Assignee: **Samsung Electronics Co., Ltd.**,  
Suwon-Si (KR)

(\*\*) Term: **14 Years**

(21) Appl. No.: **29/234,728**

(22) Filed: **Jul. 22, 2005**

(30) **Foreign Application Priority Data**

Jan. 26, 2005 (KR) ..... 30-2005-0002631

(51) **LOC (8) Cl.** ..... **14-03**

(52) **U.S. Cl.** ..... **D14/138**

(58) **Field of Classification Search** ..... D14/137,  
D14/138, 147-148, 247-248, 144, 496, 156,  
D14/341-347; 379/433.01-433.13; 348/14.02,  
348/14.01, 376; 455/575.4, 566, 575.1, 556.1,  
455/556.2, 90.3; D21/329, 331, 333; D16/208  
See application file for complete search history.

(56) **References Cited**

**U.S. PATENT DOCUMENTS**

D387,078 S	*	12/1997	Akita	.....	D16/202
D423,493 S	*	4/2000	Hakoda	.....	D14/138
D457,883 S	*	5/2002	Sugioka et al.	.....	D14/342
D466,096 S	*	11/2002	Takada	.....	D14/138
D495,695 S	*	9/2004	Yugaya	.....	D14/346
D496,645 S	*	9/2004	Yoo et al.	.....	D14/138
D498,736 S	*	11/2004	Lee	.....	D14/138
D501,475 S	*	2/2005	Kim	.....	D14/346
D503,164 S	*	3/2005	Park et al.	.....	D14/138
D508,029 S	*	8/2005	Lee	.....	D14/138
D508,473 S	*	8/2005	Lee et al.	.....	D14/138
D517,038 S	*	3/2006	Lee et al.	.....	D14/138
D521,480 S	*	5/2006	Ou et al.	.....	D14/138
2003/0064688 A1	*	4/2003	Mizuta et al.	.....	455/90

2004/0259592 A1	*	12/2004	Taneya et al.	.....	455/556.1
2005/0009581 A1	*	1/2005	Im et al.	.....	455/575.4
2005/0090298 A1	*	4/2005	Park et al.	.....	455/575.4
2005/0124381 A1	*	6/2005	Kim et al.	.....	455/556.1
2005/0124398 A1	*	6/2005	Lee et al.	.....	455/575.4
2005/0190291 A1	*	9/2005	Kota et al.	.....	348/376
2005/0233708 A1	*	10/2005	Im et al.	.....	455/90.3
2005/0255897 A1	*	11/2005	Lee et al.	.....	455/575.4
2005/0266897 A1	*	12/2005	Ahn et al.	.....	455/575.1
2006/0025184 A1	*	2/2006	Cho et al.	.....	455/575.4

**OTHER PUBLICATIONS**

Samsung D720 telephone, announced 1st quarter 2005, [online], [retrieved on May 29, 2006]. Retrieved from Internet ,URL:http://www.gsmarena.com>.\*

Samsung D820 telephone, announced 4th quarter 2005, [online], [retrieved on Apr. 29, 2006]. Retrieved from Internet ,URL:http://www.gsmarena.com>.\*

Samsung D800 telephone, announced 4th quarter 2005, [online], [retrieved on Apr. 1, 2006]. Retrieved from Internet ,URL:http://www.gsmarena.com>.\*

\* cited by examiner

*Primary Examiner*—Jeffrey Asch

(74) *Attorney, Agent, or Firm*—Staas & Halsey LLP

(57) **CLAIM**

The ornamental design for the portable phone, as shown and described.

**DESCRIPTION**

FIG. 1 is a perspective view of the portable phone showing our design;

FIG. 2 is a front view thereof;

FIG. 3 is a rear view thereof;

FIG. 4 is a left side view thereof;

FIG. 5 is a right side view thereof;

FIG. 6 is a top plan view thereof;

FIG. 7 is a bottom plan view thereof; and,

FIG. 8 is an open view thereof.

**1 Claim, 5 Drawing Sheets**

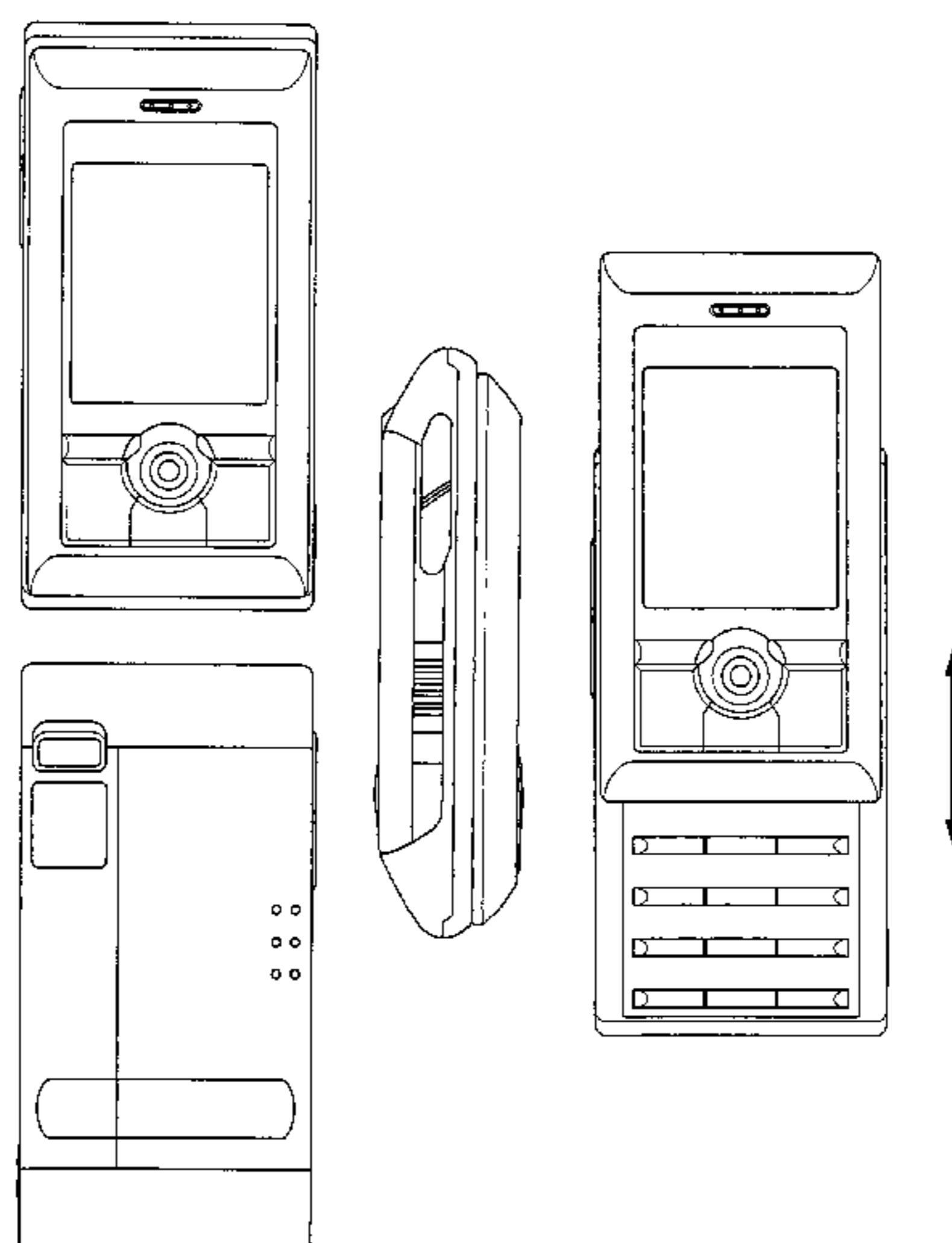

**FIG. 1**

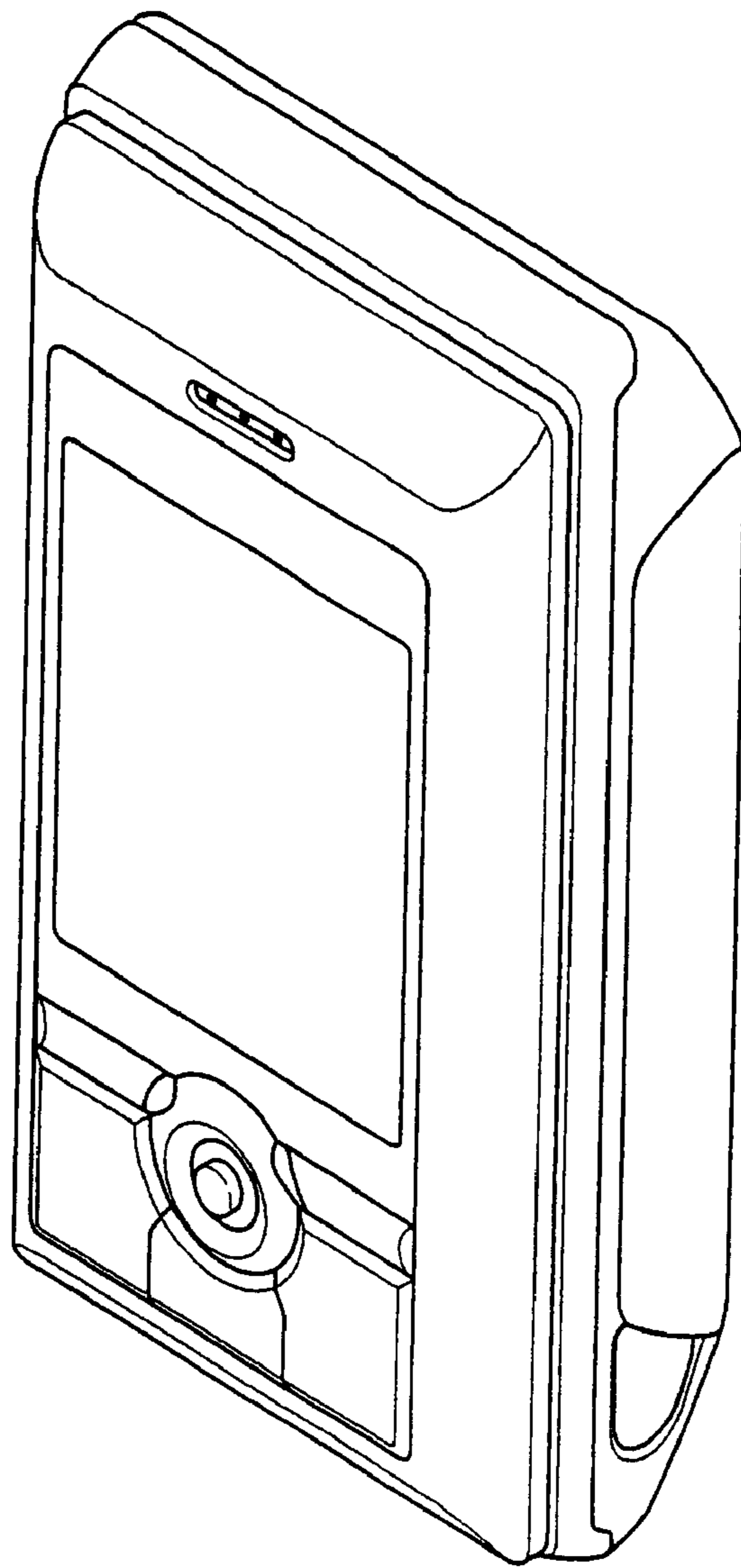

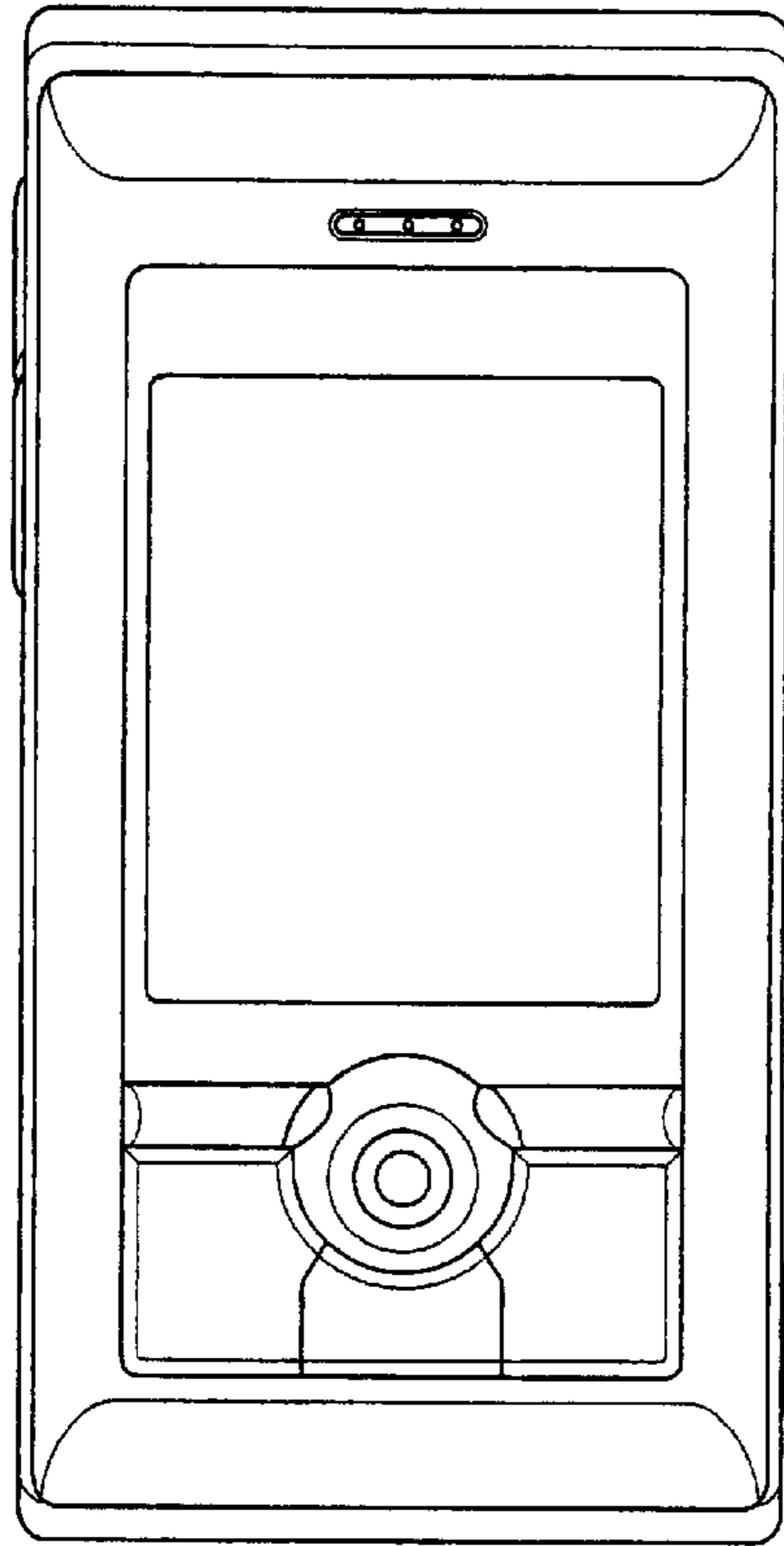

FIG. 2

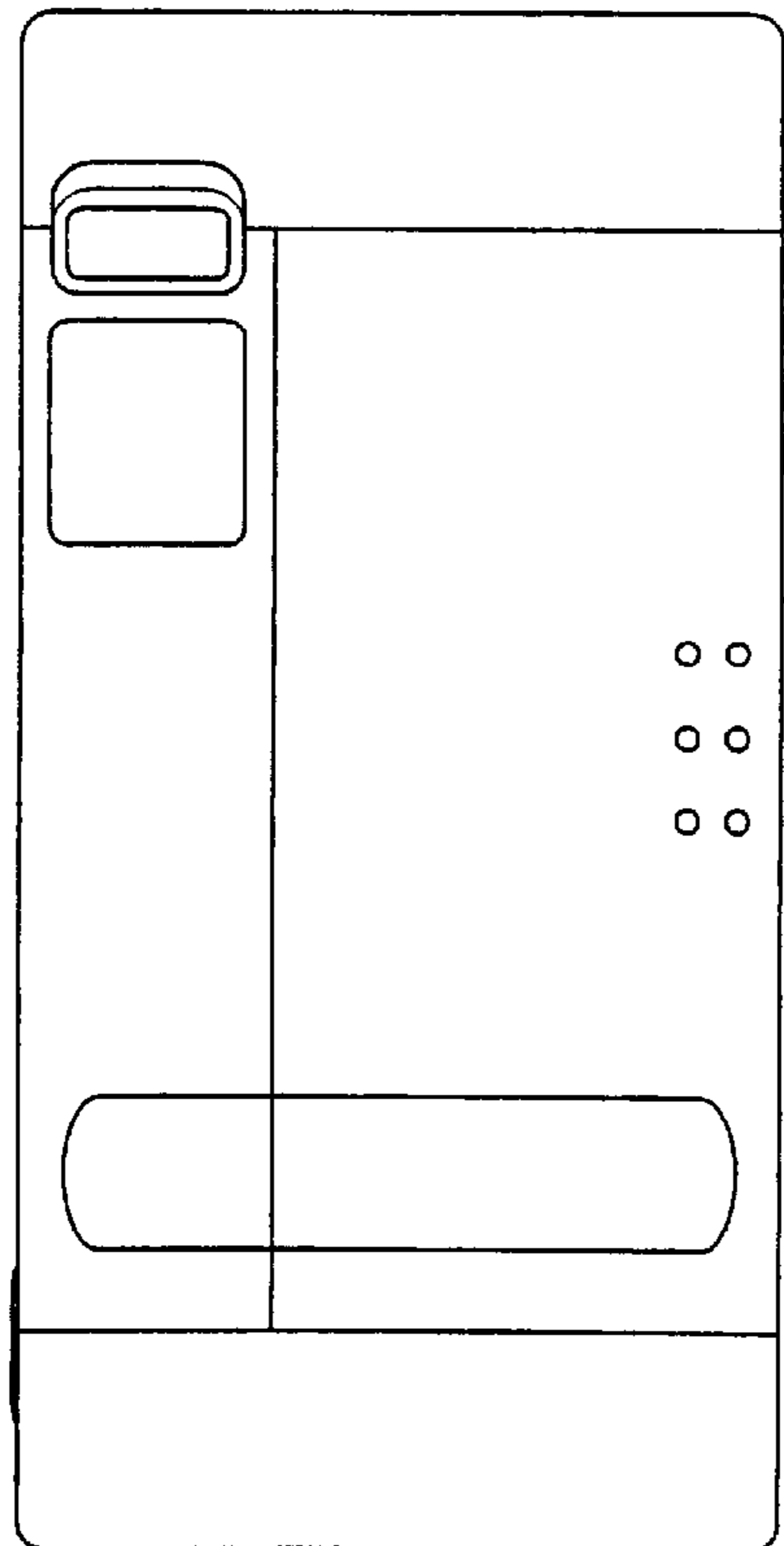
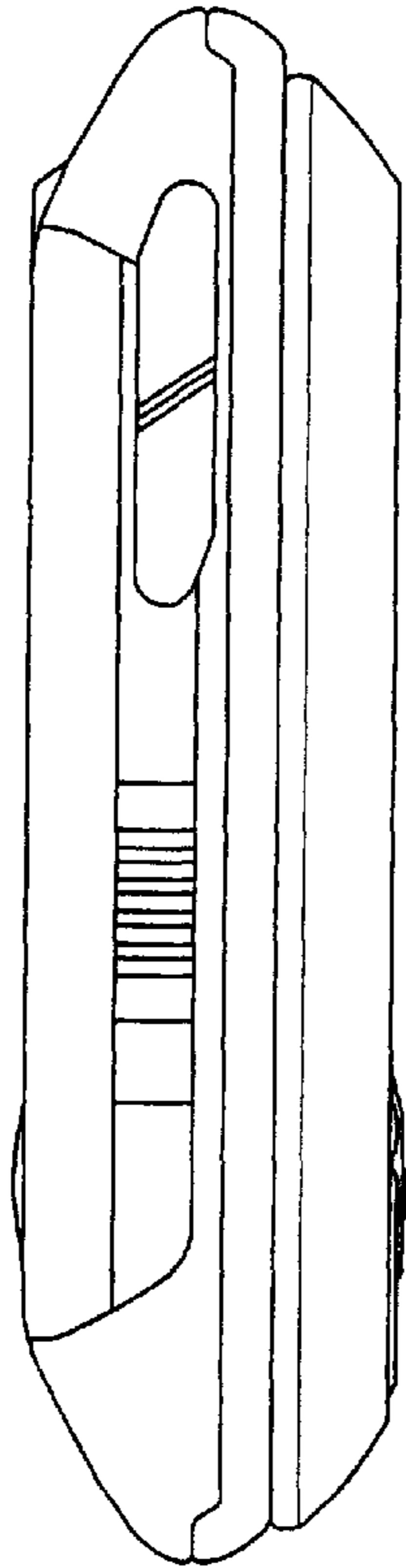
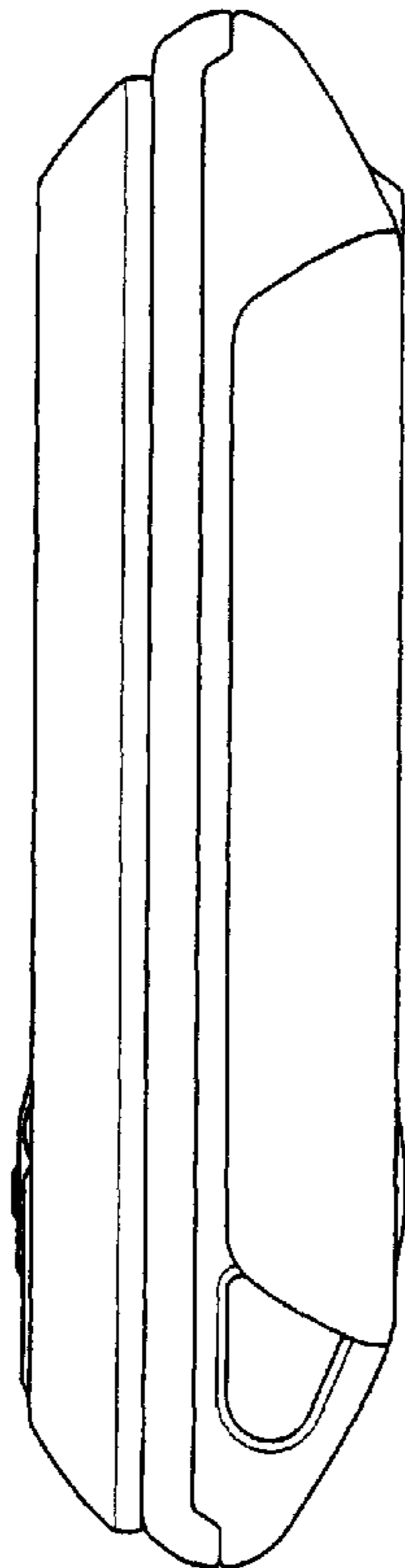

FIG. 3



**FIG. 4**



**FIG. 5**

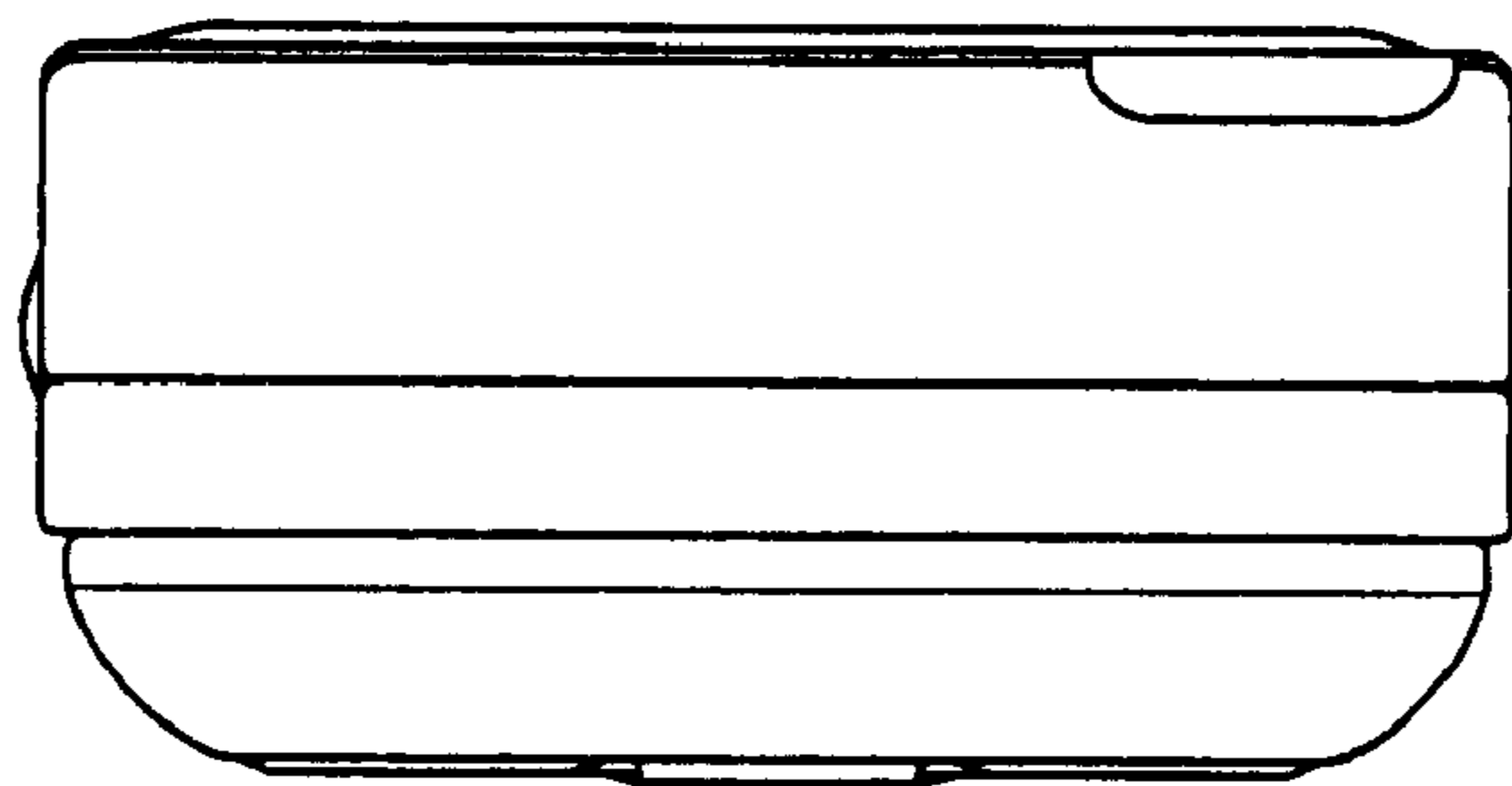

**FIG. 6**

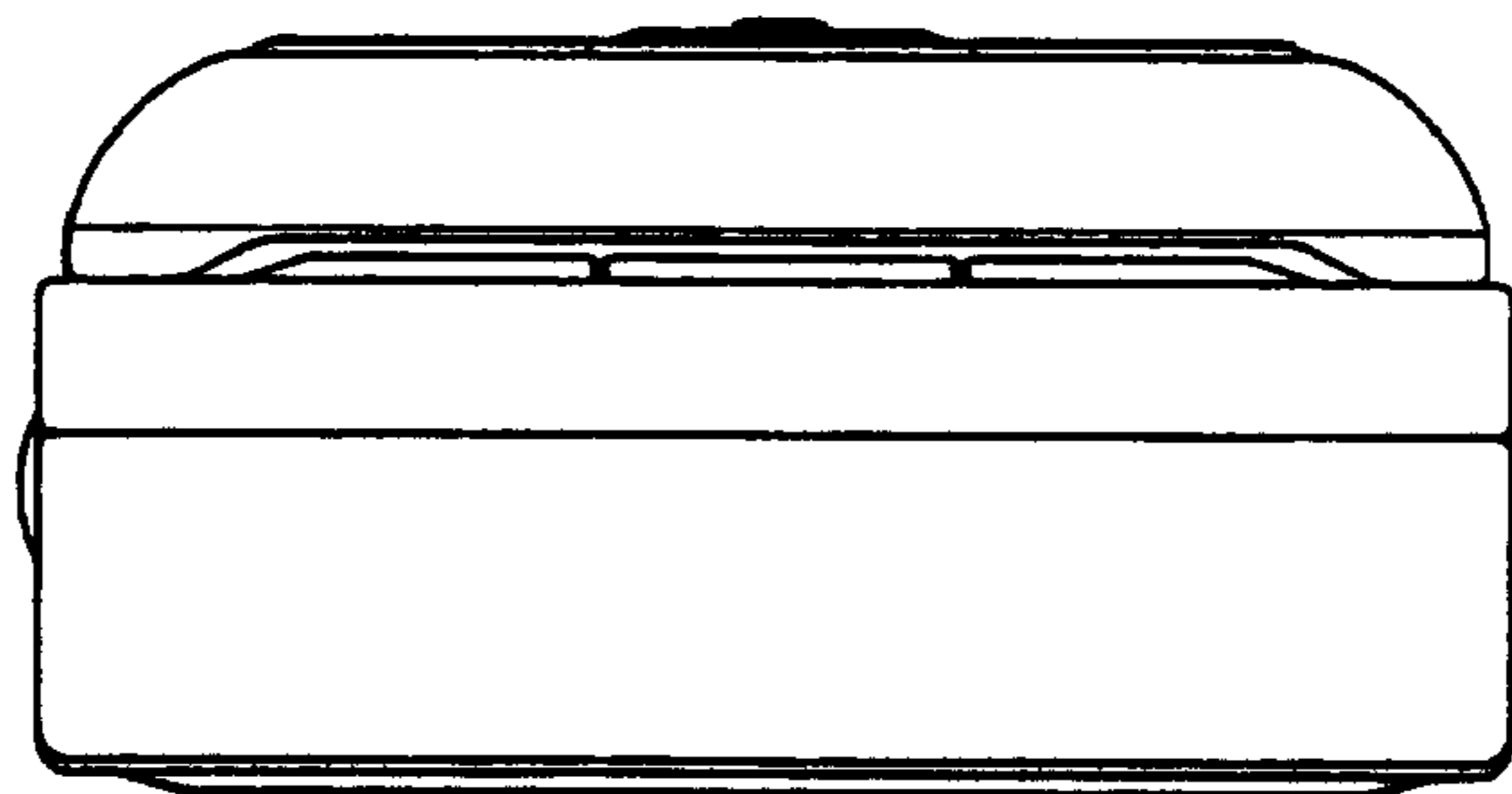

**FIG. 7**

**FIG. 8**

