



US00D531583S

(12) **United States Design Patent**
Suzuki

(10) **Patent No.:** **US D531,583 S**

(45) **Date of Patent:** **** Nov. 7, 2006**

(54) **PHOTOELECTRIC SWITCH**

(75) Inventor: **Nobuaki Suzuki**, Funai-gun (JP)

(73) Assignee: **Rohm Co., Ltd.**, Kyoto (JP)

(**) Term: **14 Years**

(21) Appl. No.: **29/238,667**

(22) Filed: **Sep. 19, 2005**

(30) **Foreign Application Priority Data**

Mar. 22, 2005 (JP) 2005-008388

(51) **LOC (8) Cl.** **13-03**

(52) **U.S. Cl.** **D13/165**

(58) **Field of Classification Search** D13/165;
250/221, 221.1, 239, 551; 257/82, 98, 99,
257/433, 678, 690; 313/500
See application file for complete search history.

(56) **References Cited**

U.S. PATENT DOCUMENTS

5,291,038	A	*	3/1994	Hanamoto et al.	257/82
5,672,884	A	*	9/1997	Muhleck et al.	250/551
5,814,837	A	*	9/1998	Okazaki	257/91
5,942,770	A	*	8/1999	Ishinaga et al.	257/89
5,966,052	A	*	10/1999	Sakai	331/68
RE36,614	E	*	3/2000	Lumbard et al.	313/500
6,097,084	A	*	8/2000	Sano et al.	257/678
6,383,835	B1	*	5/2002	Hata et al.	438/65

6,399,943	B1	*	6/2002	Sano	250/239
6,459,099	B1	*	10/2002	Sano	257/82
6,476,410	B1	*	11/2002	Ishinaga	257/13
6,509,584	B1	*	1/2003	Suzuki	257/98
6,734,750	B1	*	5/2004	Ostergaard	333/1
D510,912	S	*	10/2005	Asakawa	D13/180
2004/0099874	A1	*	5/2004	Chang et al.	257/98

* cited by examiner

Primary Examiner—Selina Sikder

(74) *Attorney, Agent, or Firm*—Hambre, Schumann, Mueller & Larson, P.C.

(57) **CLAIM**

I claim the ornamental design for a photoelectric switch, as shown and described.

DESCRIPTION

FIG. 1 is a front view of a photoelectric switch showing my new design, the rear view being a mirror image thereof; FIG. 2 is a right side view of the same photoelectric switch, a left side view being identical to the right side view; FIG. 3 is a top plan view of the same photoelectric switch; FIG. 4 is a bottom view of the same photoelectric switch; FIG. 5 is a sectional view of the same photoelectric switch taken along 5—5 lines in FIG. 1; FIG. 6 is a sectional view of the same photoelectric switch taken along 6—6 in FIG. 3; and, FIG. 7 is a perspective view of the same photoelectric switch.

1 Claim, 2 Drawing Sheets

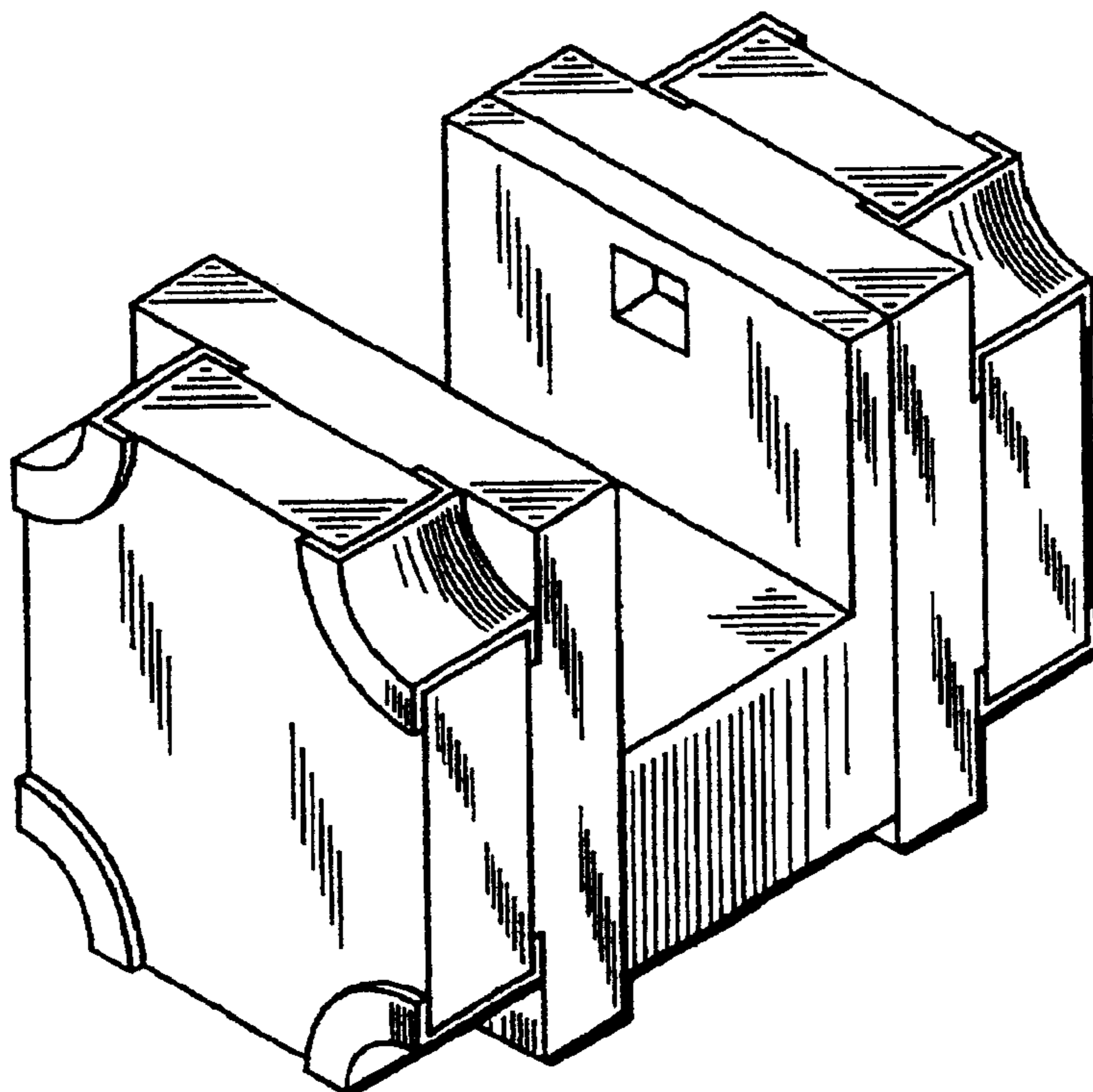

FIG. 1

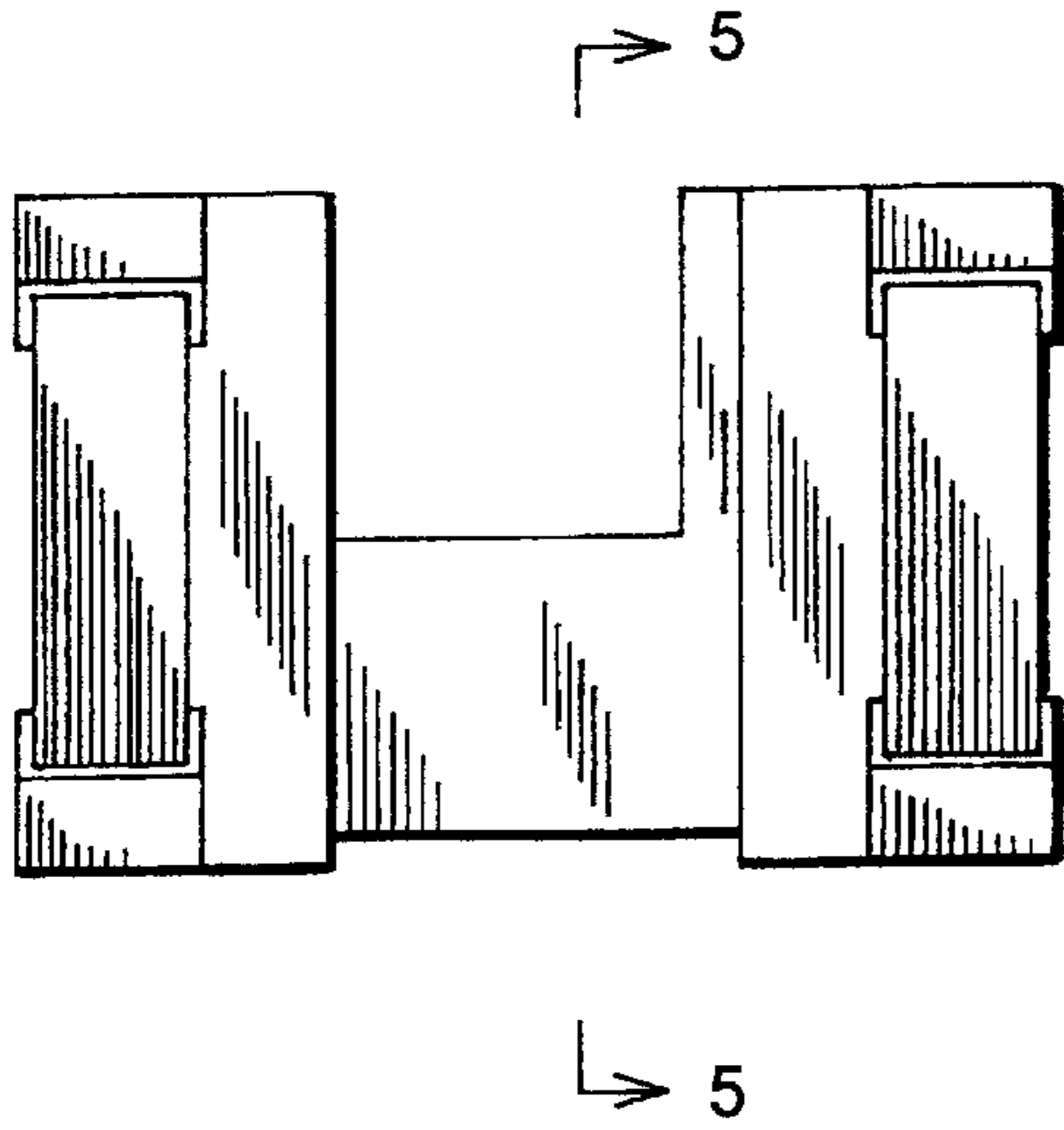

FIG. 2

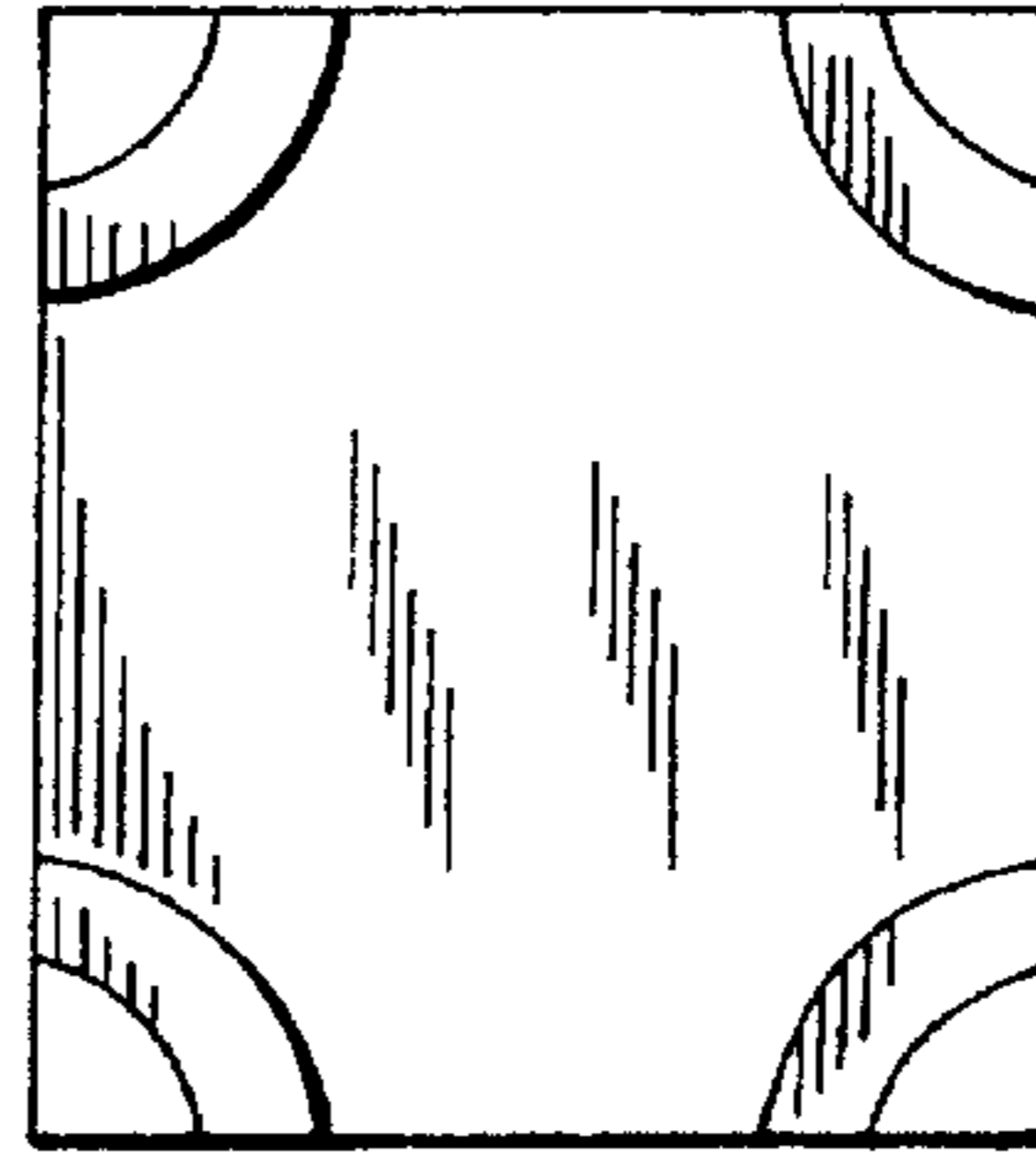

FIG. 3

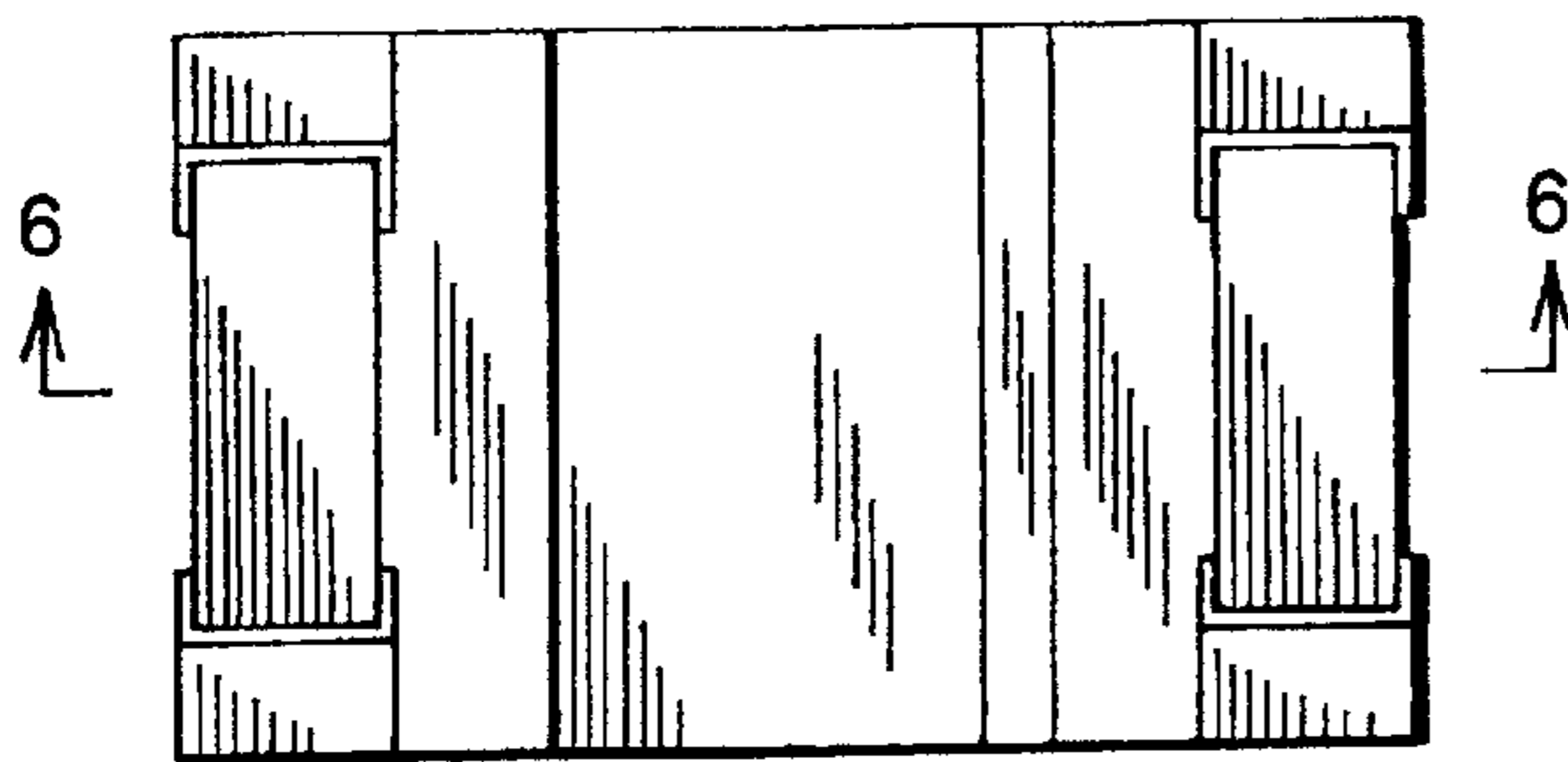

FIG. 4

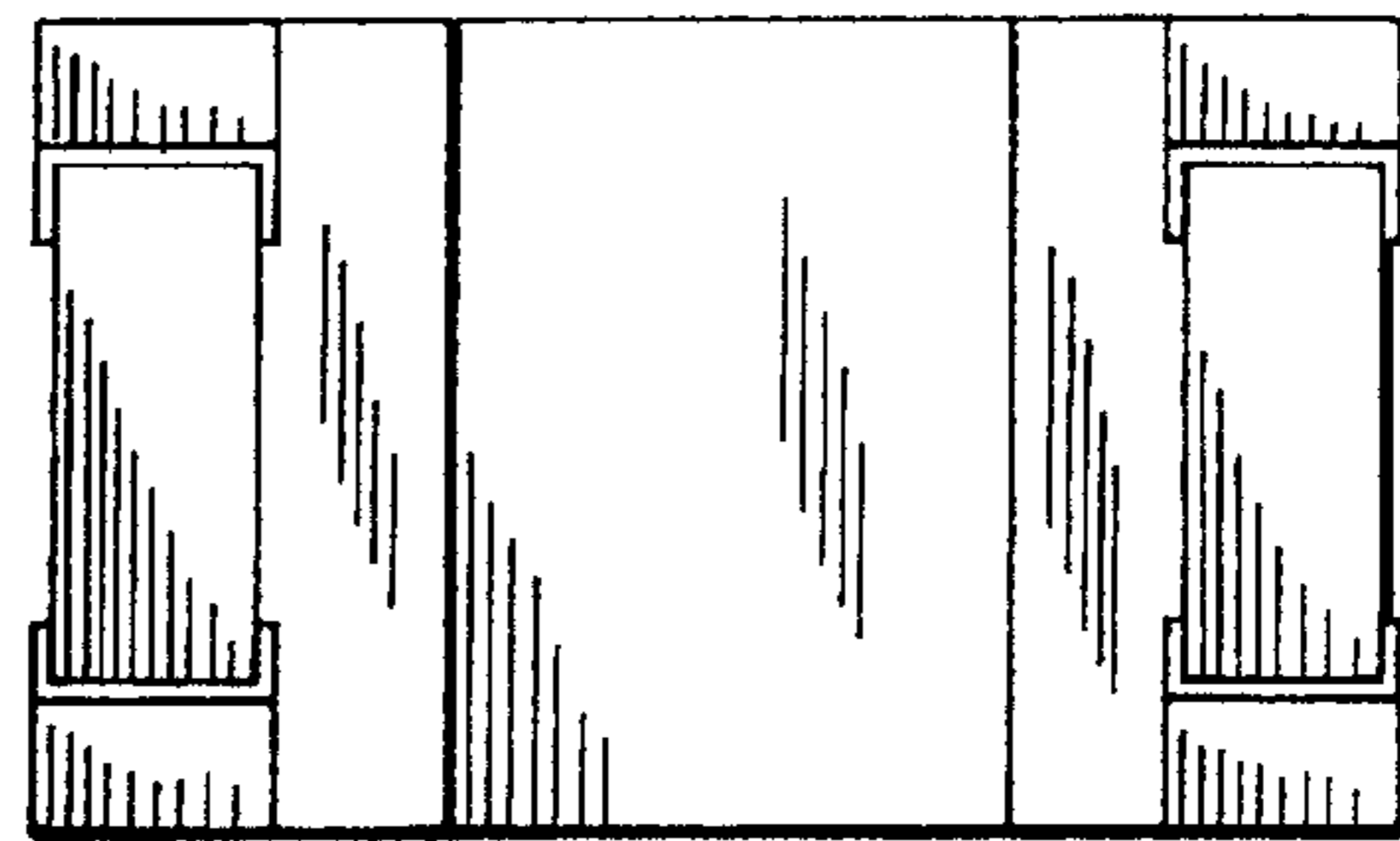

FIG. 5

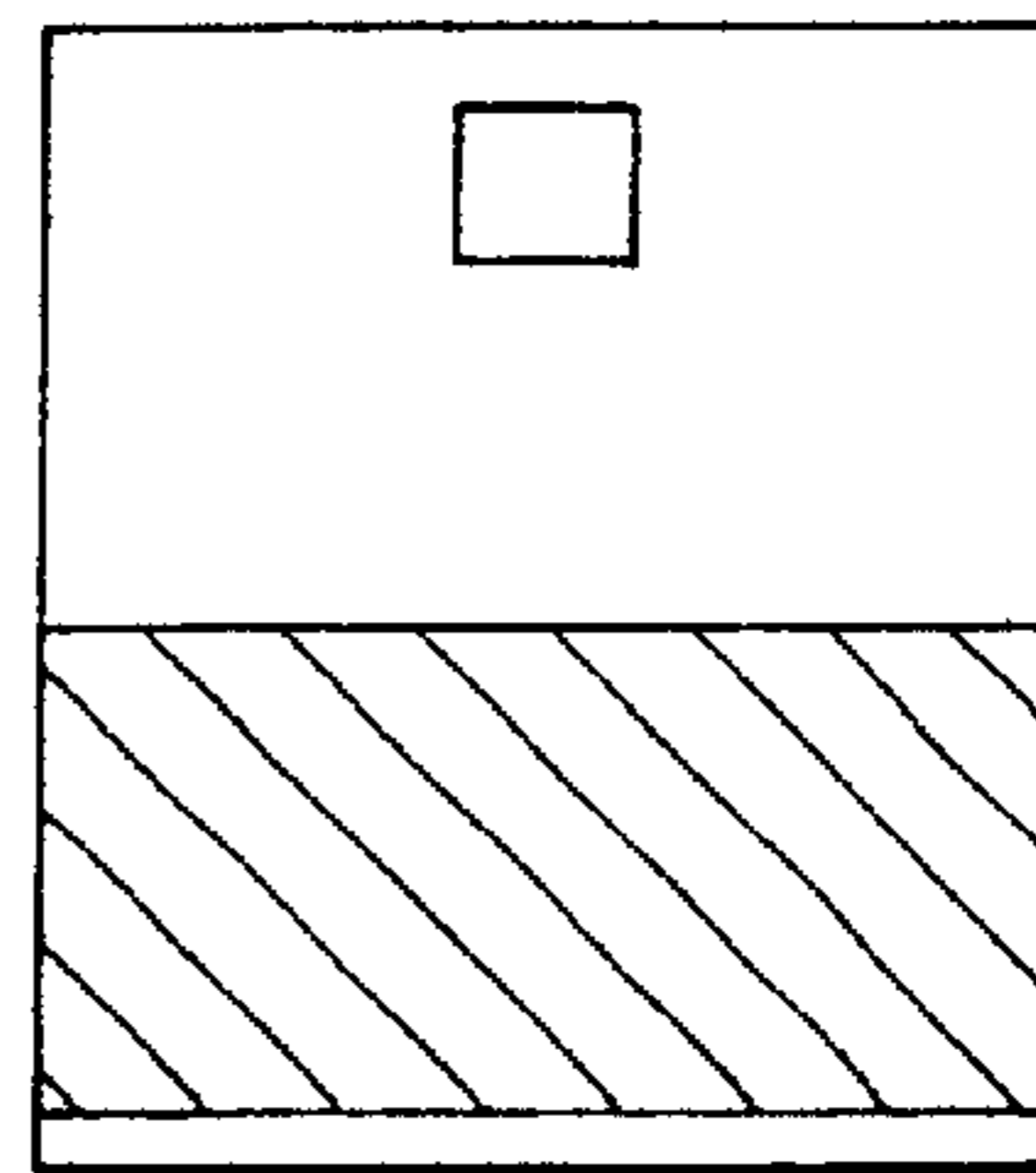

FIG. 6

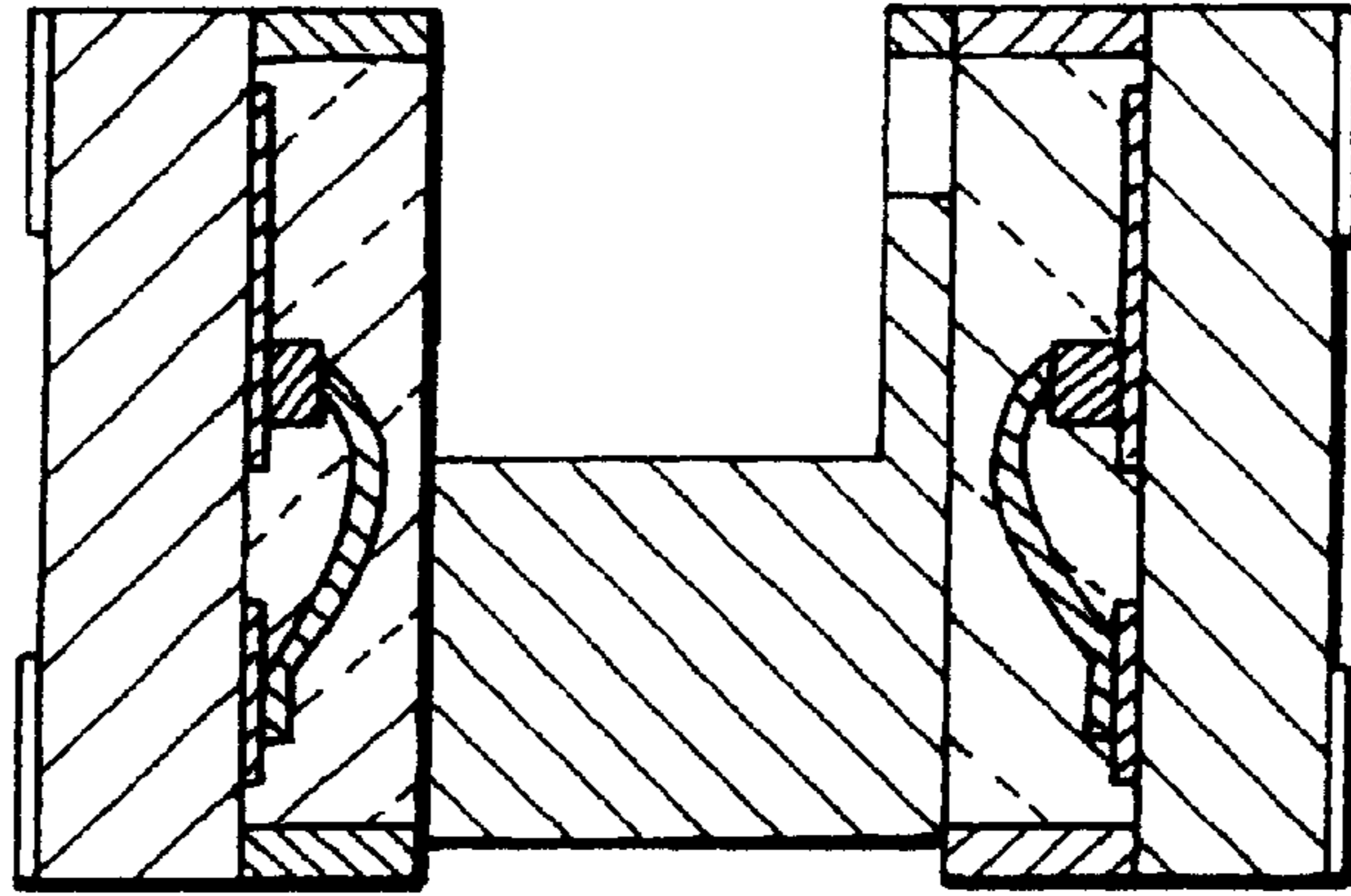

FIG. 7

