



US00D531338S

(12) **United States Design Patent**  
**Chen**

(10) **Patent No.:** **US D531,338 S**

(45) **Date of Patent:** **\*\* Oct. 31, 2006**

(54) **CEILING FAN LIGHT KIT**

D485,344 S \* 1/2004 Tai ..... D23/377  
D505,722 S \* 5/2005 Burns ..... D23/411

(75) Inventor: **Ken-Tuan Chen**, Tai-ping (TW)

\* cited by examiner

(73) Assignee: **Air Cool Industrial Co., Ltd.**,  
Taichung County (TW)

*Primary Examiner*—Lisa Lichtenstein

(74) *Attorney, Agent, or Firm*—Troxell Law Office, PLLC

(\*\*) Term: **14 Years**

(57) **CLAIM**

(21) Appl. No.: **29/229,854**

The ornamental design for a ceiling fan light kit, as shown and described.

(22) Filed: **May 13, 2005**

**DESCRIPTION**

(51) **LOC (8) Cl.** ..... **26-05**

(52) **U.S. Cl.** ..... **D26/59**

(58) **Field of Classification Search** ..... D26/59,  
D26/51, 72, 80-86; D23/411, 377, 379, 385;  
416/5; 362/96

FIG. 1 is a perspective view of a ceiling fan light kit showing my new design;

FIG. 2 is a front end elevation view thereof;

FIG. 3 is a rear end elevation view thereof;

FIG. 4 is a left side elevation view thereof;

FIG. 5 is a right side elevation view thereof;

FIG. 6 is a top plan view thereof; and,

FIG. 7 is a bottom plan view thereof.

See application file for complete search history.

(56) **References Cited**

**U.S. PATENT DOCUMENTS**

D418,914 S \* 1/2000 Zuege ..... D23/411

**1 Claim, 7 Drawing Sheets**

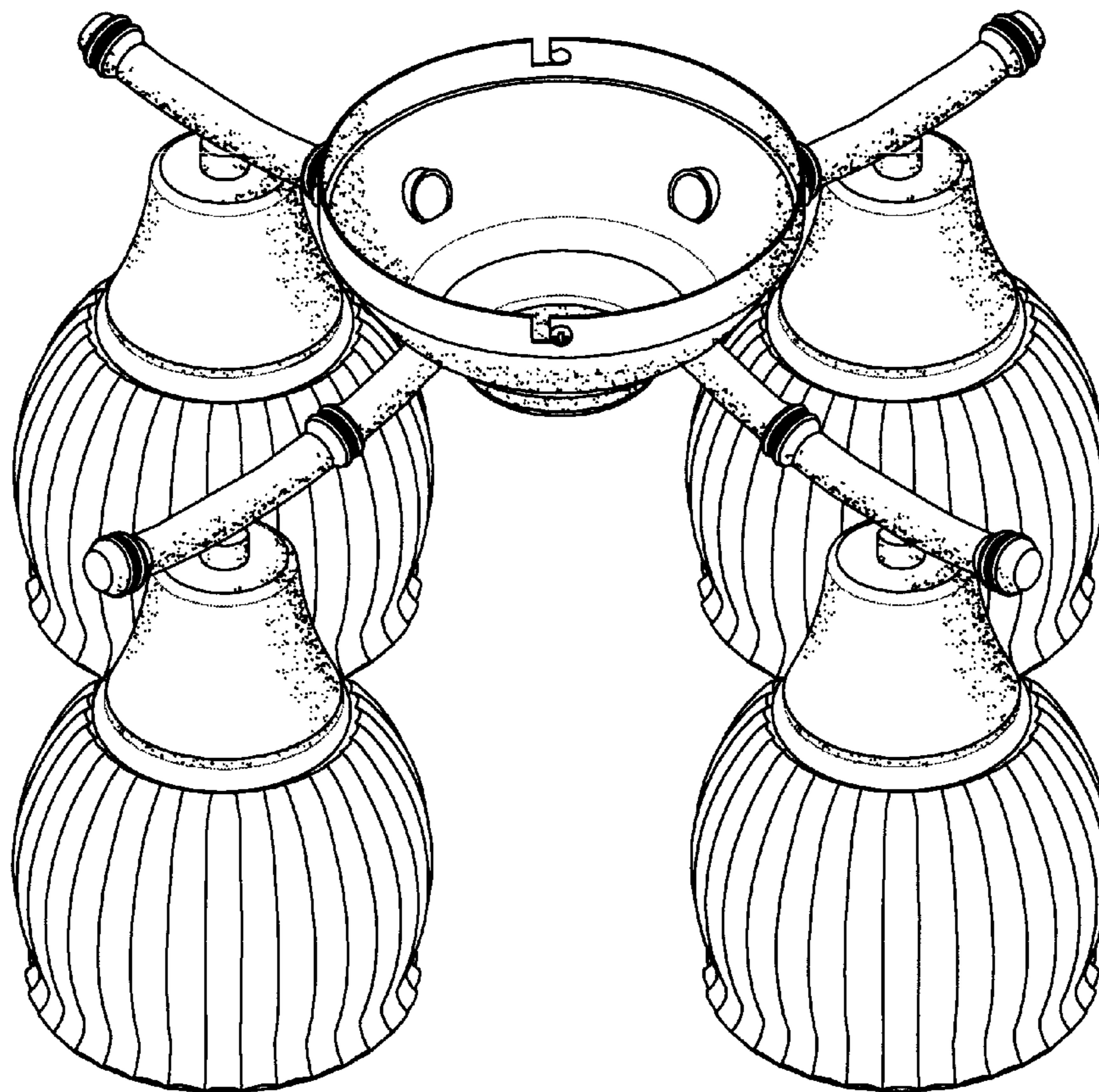

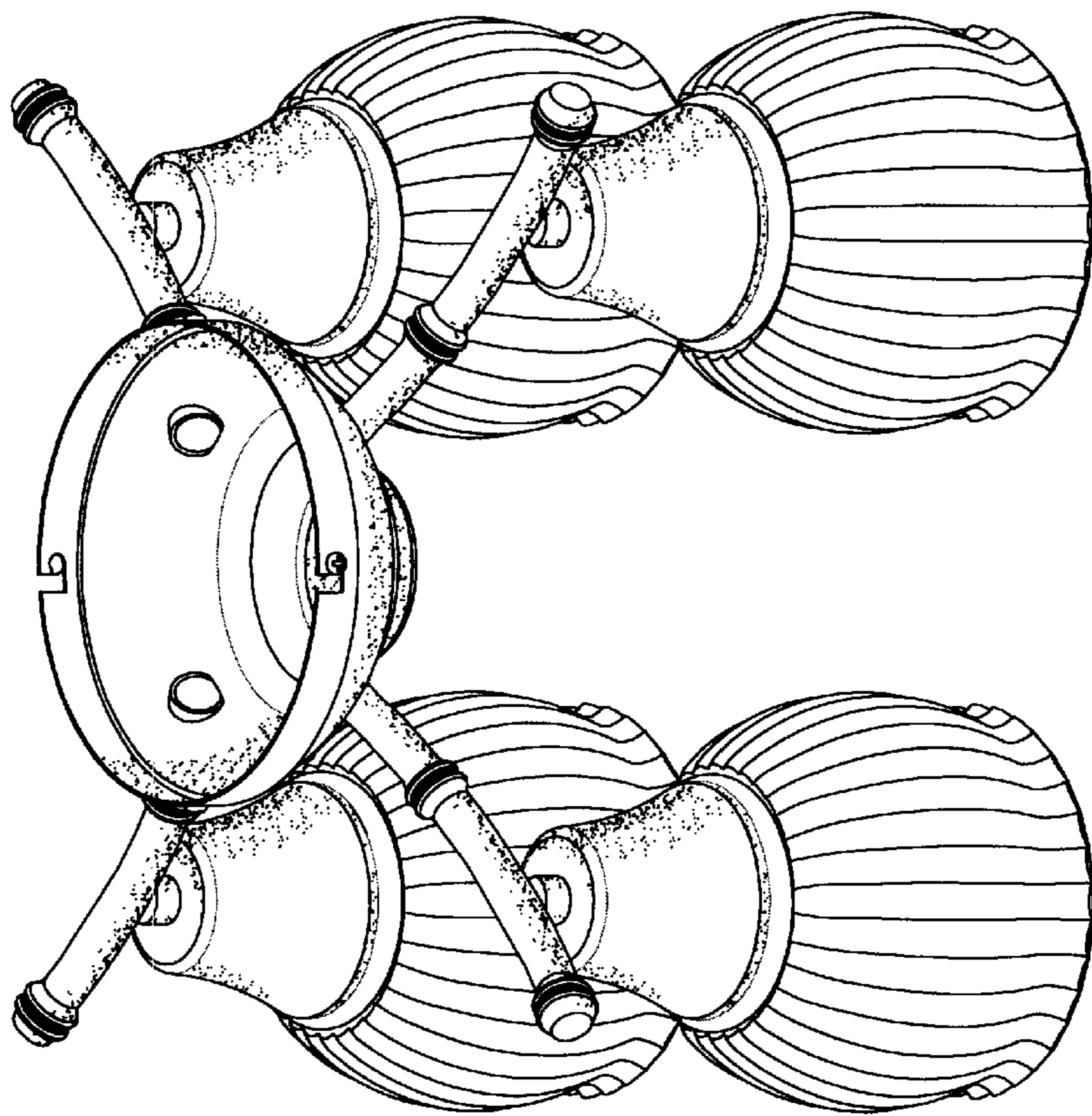

FIG. 1

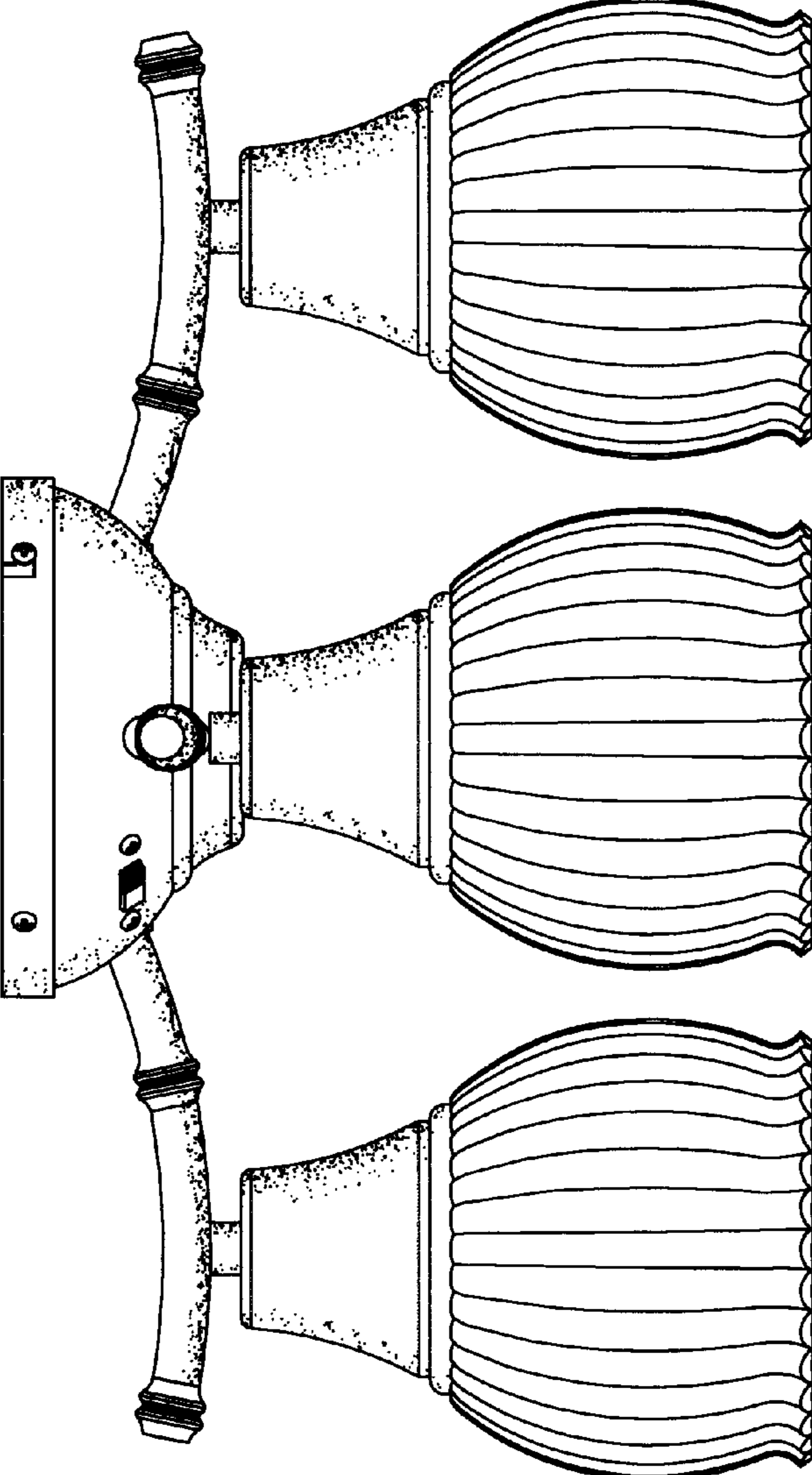

FIG. 2

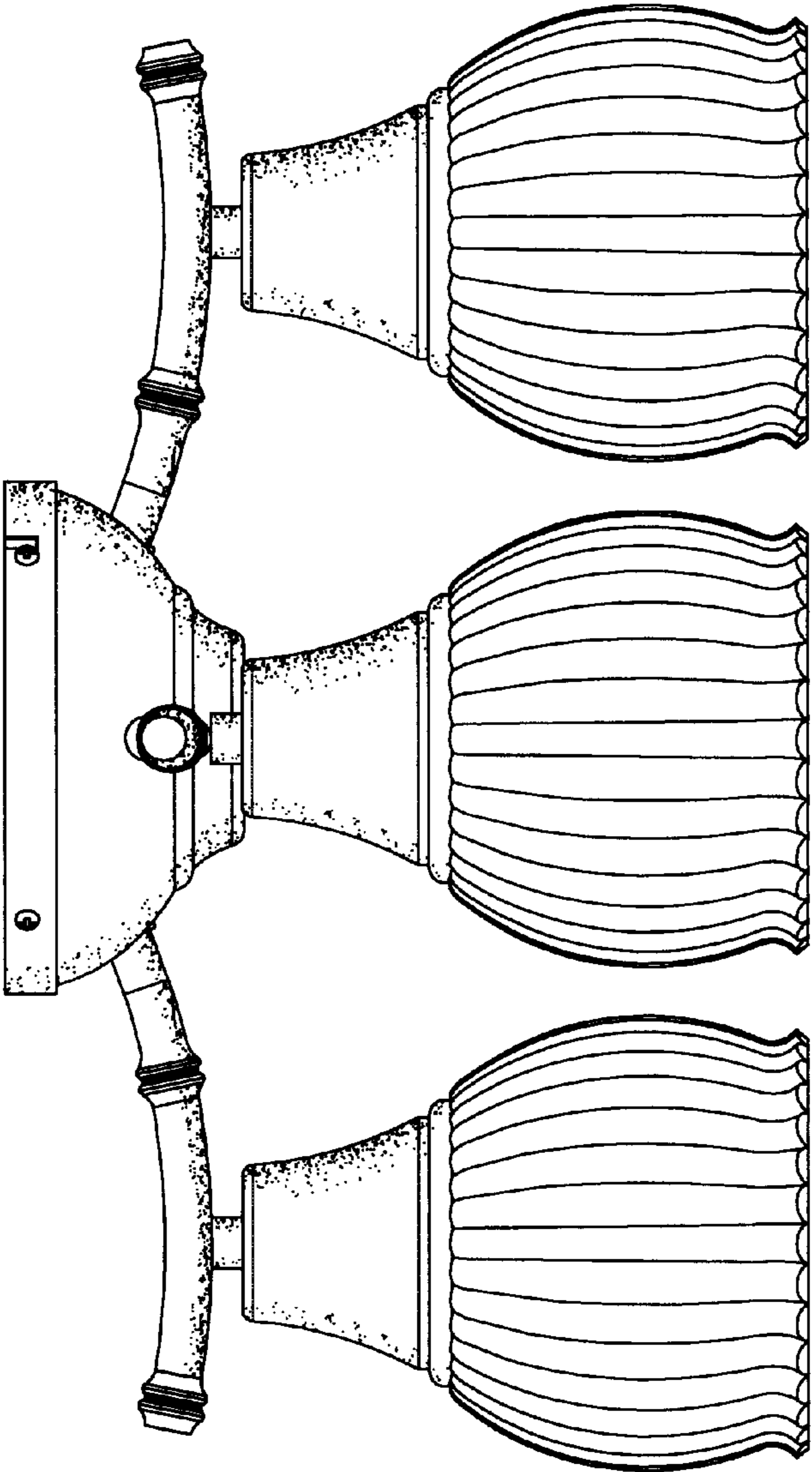

FIG. 3

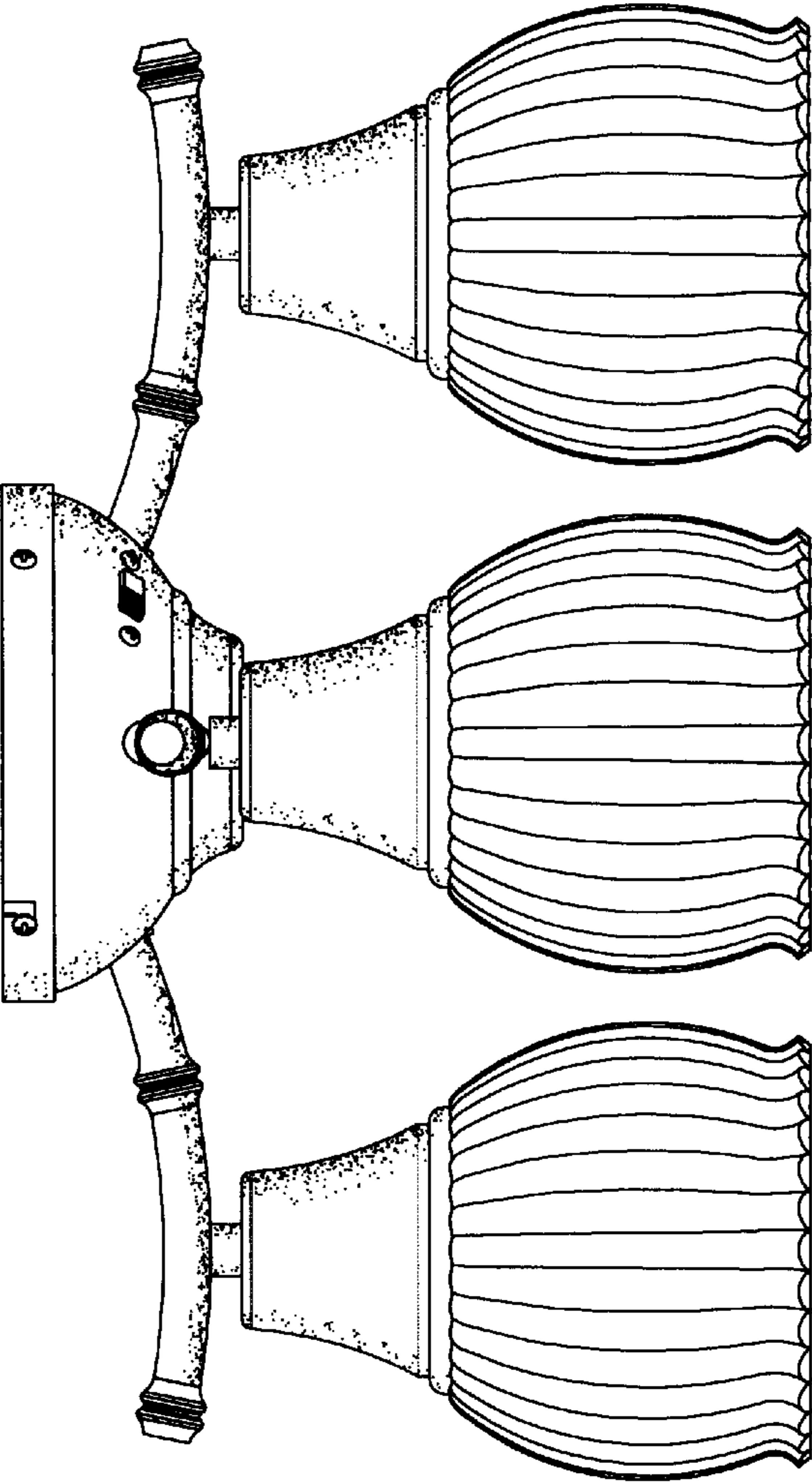

FIG. 4

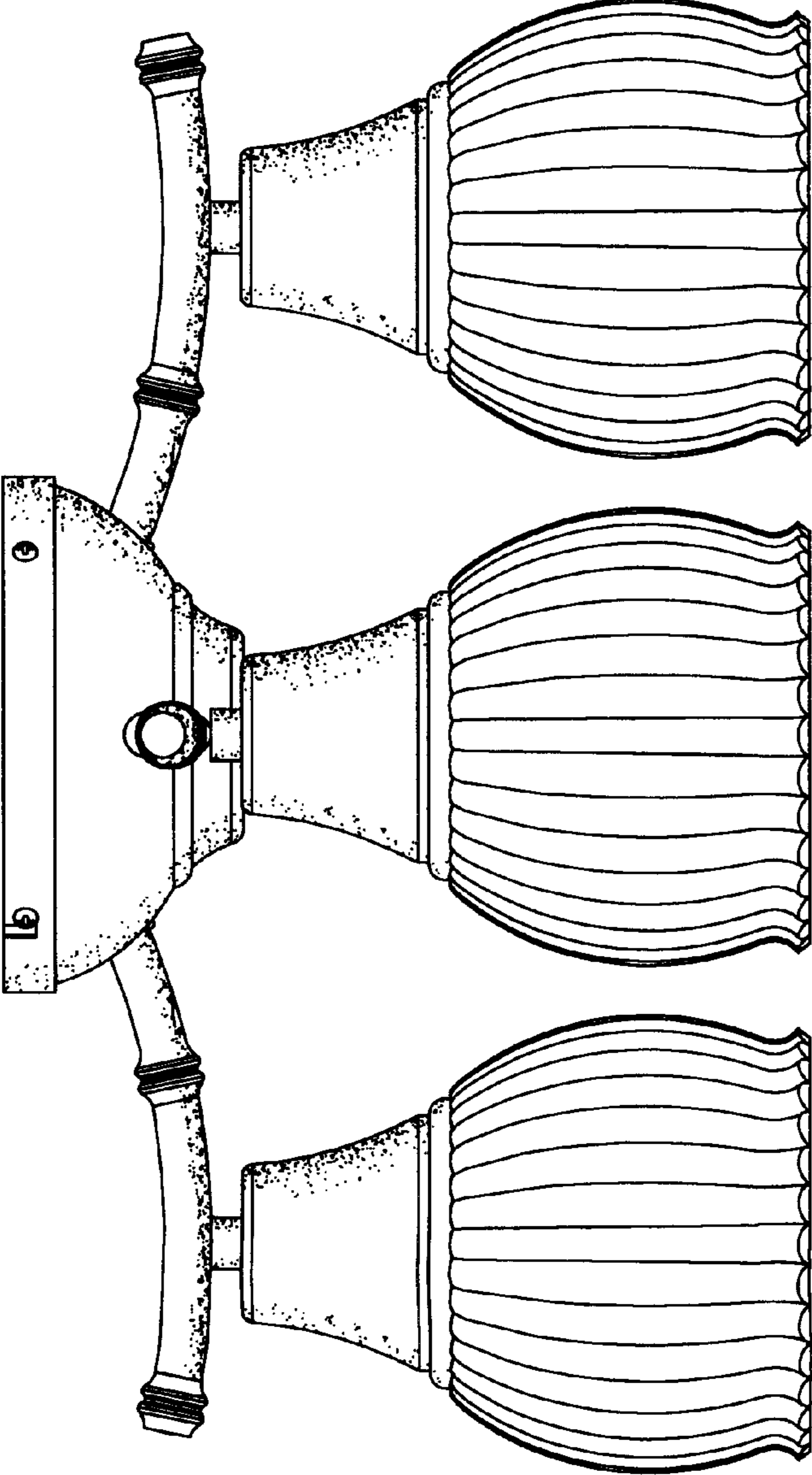

FIG. 5

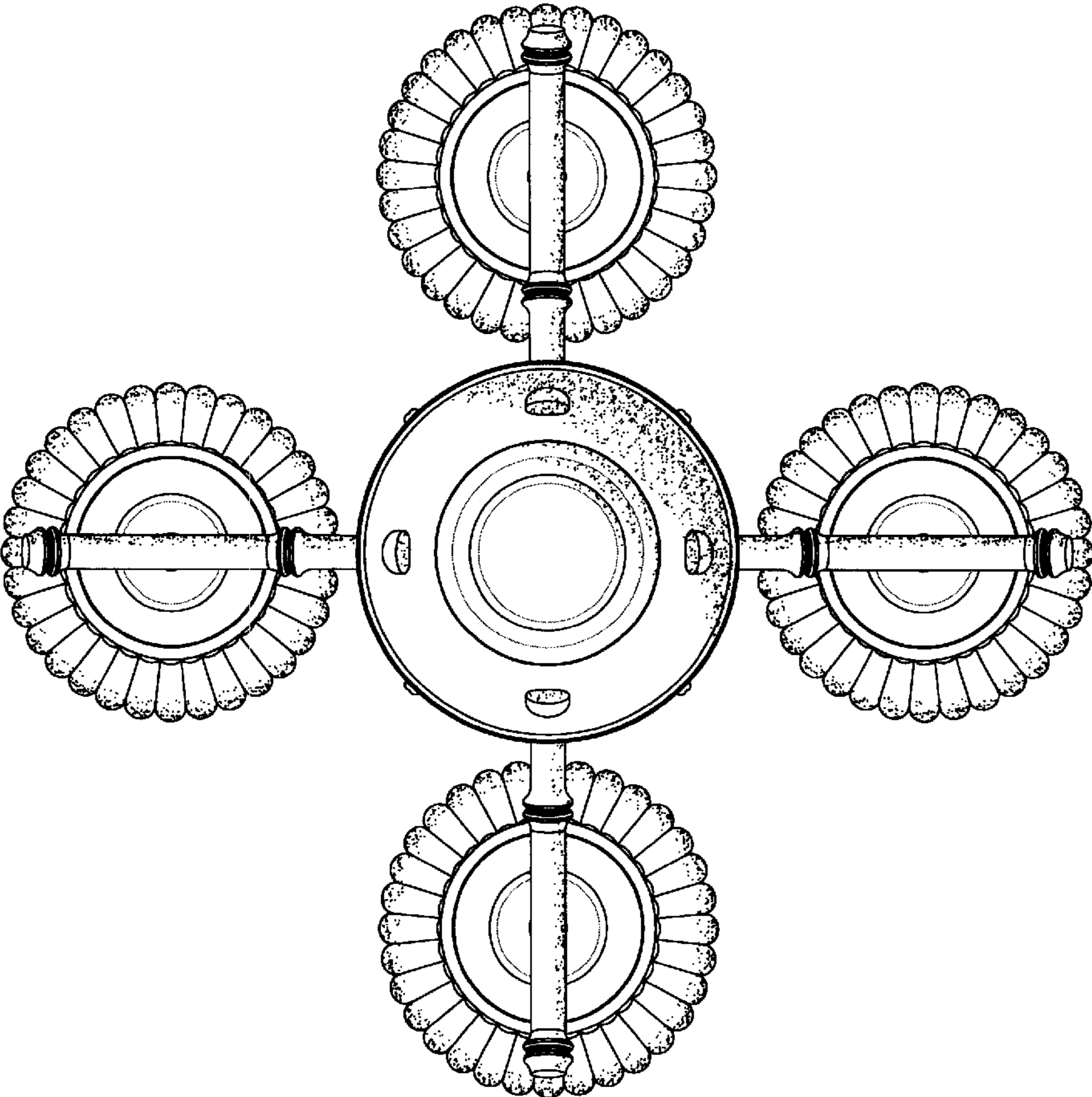

FIG. 6

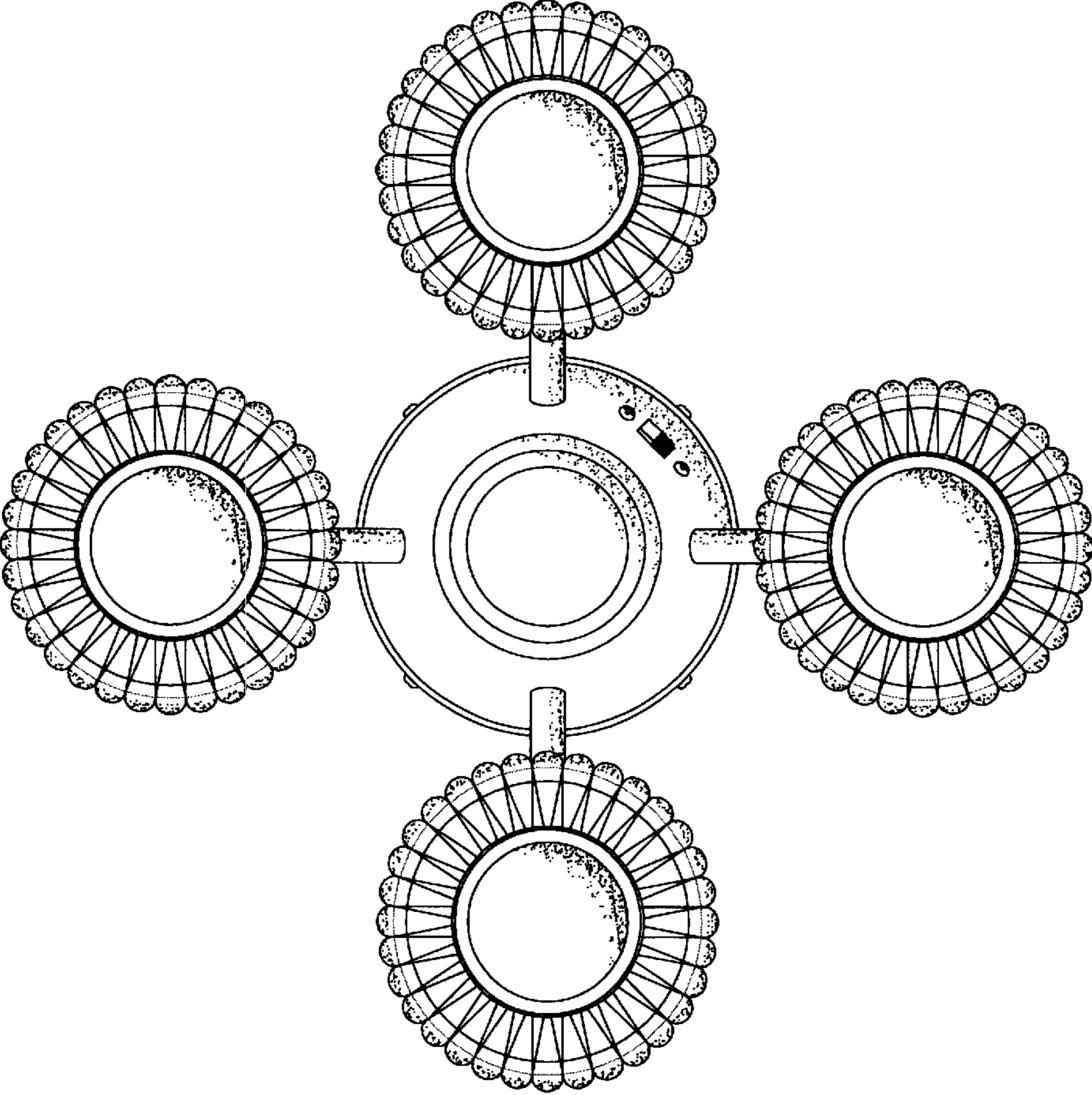

FIG. 7