



US00D531328S

(12) **United States Design Patent** (10) **Patent No.:** **US D531,328 S**
Okamura et al. (45) **Date of Patent:** **** Oct. 31, 2006**

(54) **REAR COMBINATION LAMP FOR AN AUTOMOBILE**

(75) Inventors: **Kenichi Okamura**, Nagoya (JP); **Naoki Kazaoka**, Shizuoka (JP)

(73) Assignee: **Toyota Jidosha Kabushiki Kaisha**, Aichi-ken (JP)

(**) Term: **14 Years**

(21) Appl. No.: **29/239,557**

(22) Filed: **Oct. 3, 2005**

(51) **LOC (8) Cl.** **26-06**

(52) **U.S. Cl.** **D26/28**

(58) **Field of Classification Search** D26/28-36;
362/459-468, 475-478, 485-487
See application file for complete search history.

(56) **References Cited**

U.S. PATENT DOCUMENTS

D502,780 S	*	3/2005	Tamura	D26/28
D519,223 S	*	4/2006	Hosoda et al.	D26/28
D519,229 S	*	4/2006	Hirokawa et al.	D26/28
D521,662 S	*	5/2006	Chu	D26/28

OTHER PUBLICATIONS

Brochure for Toyota Crown, issued by Toyota Jidosha Kabushiki Kaisha, Aug. 2000.

Mercedes Benz E Class in "Nihonban Sekai no Jidosha Catalog," issued by Seibido Shuppan Kabushiki Kaisha, Jan. 10, 2000.

* cited by examiner

Primary Examiner—Marcus A. Jackson

(74) *Attorney, Agent, or Firm*—Finnegan, Henderson, Farabow, Garrett & Dunner, L.L.P.

(57) **CLAIM**

The ornamental design for a rear combination lamp for an automobile, as shown and described.

DESCRIPTION

FIG. 1 is a perspective view of a rear combination lamp for an automobile of our new design;
FIG. 2 is a front view thereof;
FIG. 3 is a rear view thereof;
FIG. 4 is a top plan view thereof;
FIG. 5 is a bottom plan view thereof;
FIG. 6 is a left side view thereof; and,
FIG. 7 is a right side view thereof.

Our design includes the mirror image of the embodiment depicted. As used herein right and left refer to the orientation of the design depicted in the figures above, not the right and left sides of the device when it is included as a component of an automobile.

1 Claim, 4 Drawing Sheets

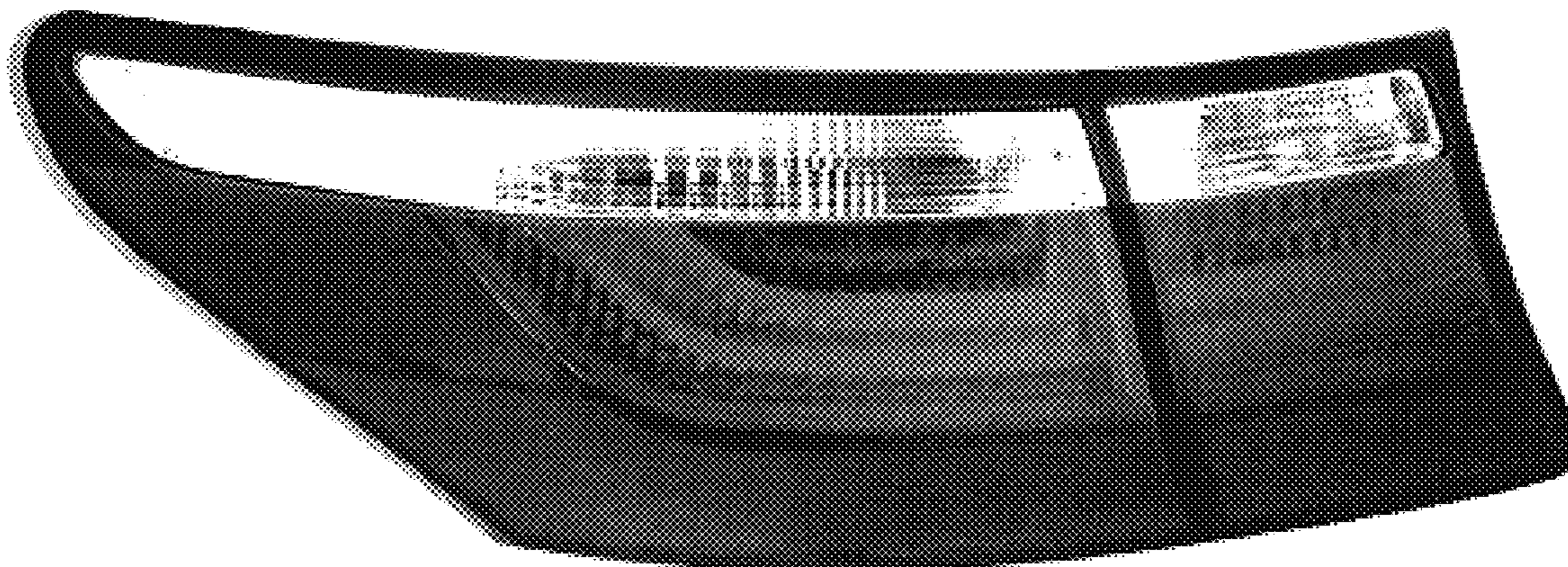

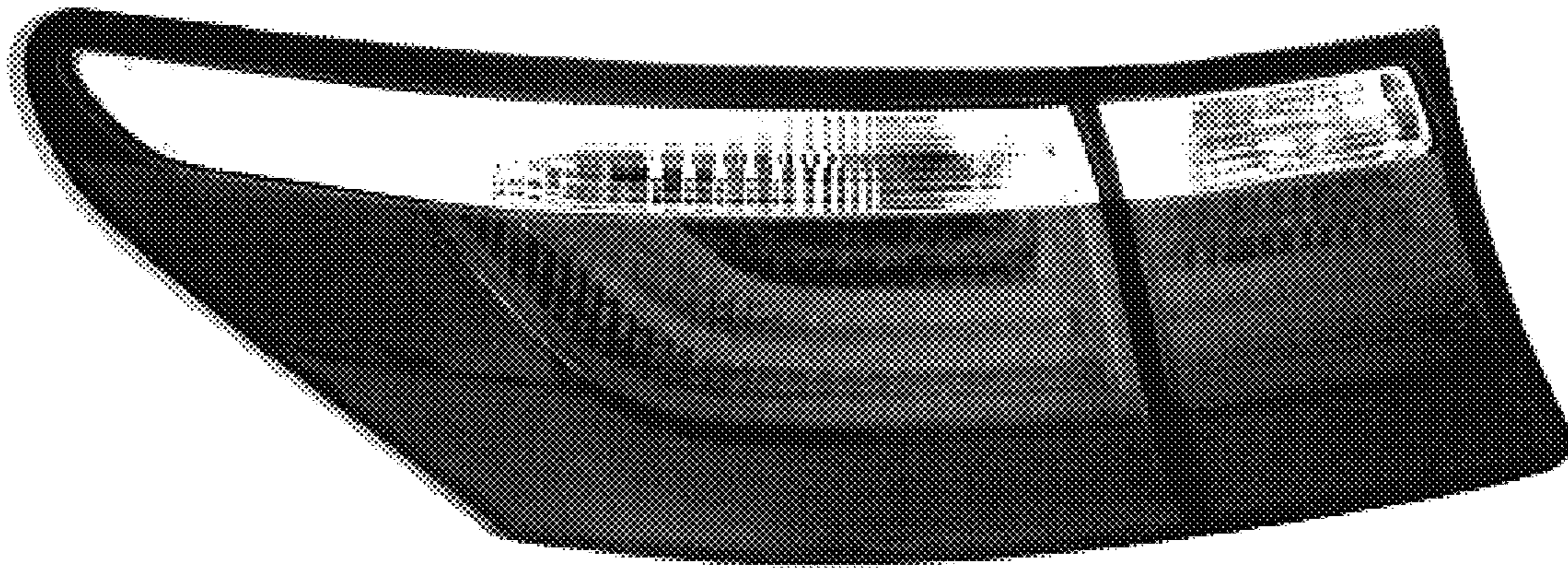

FIG. 1

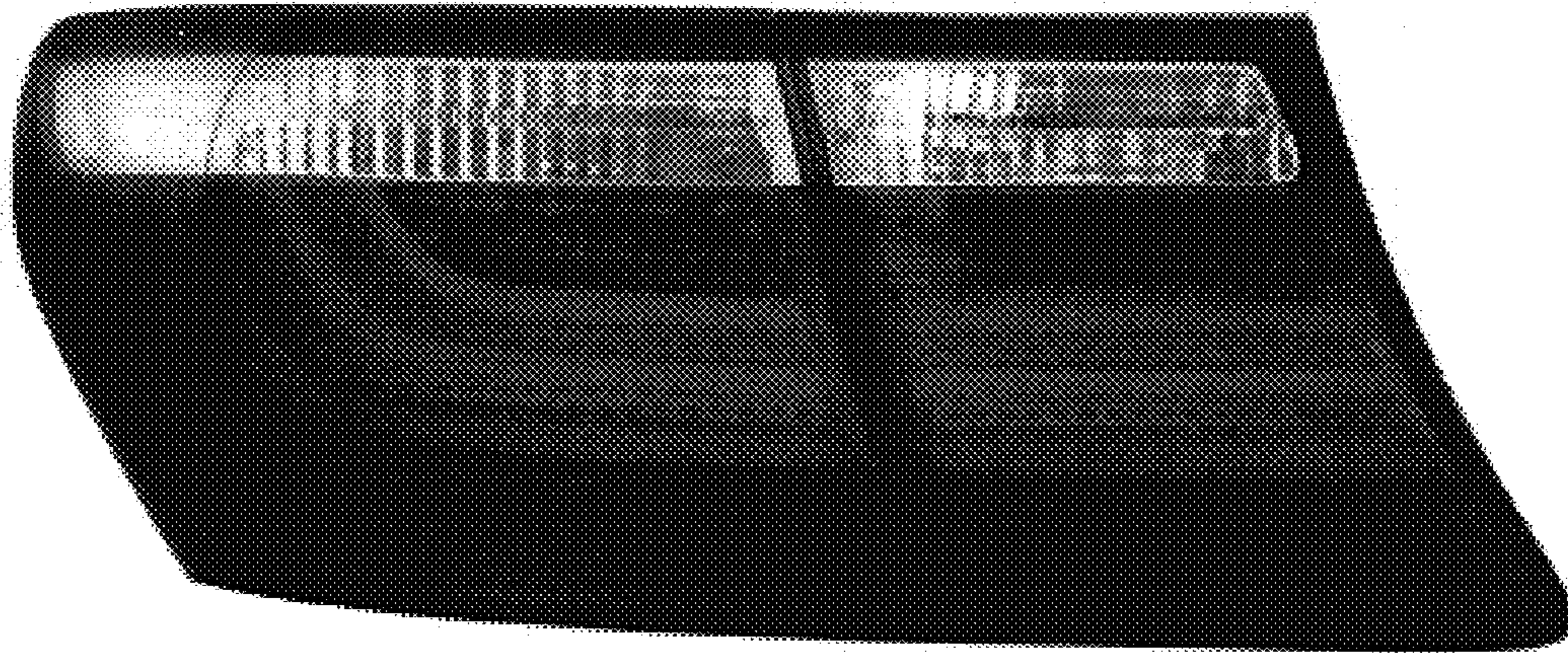

FIG. 2

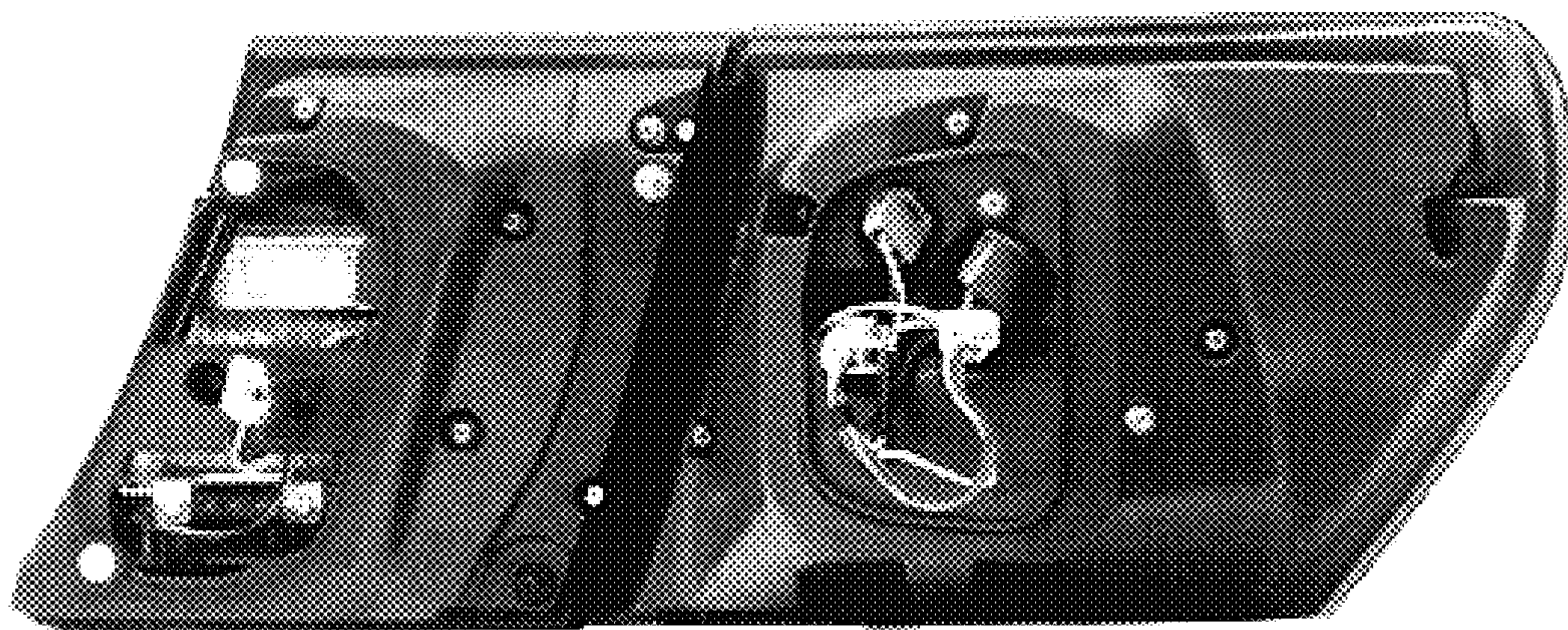

FIG. 3

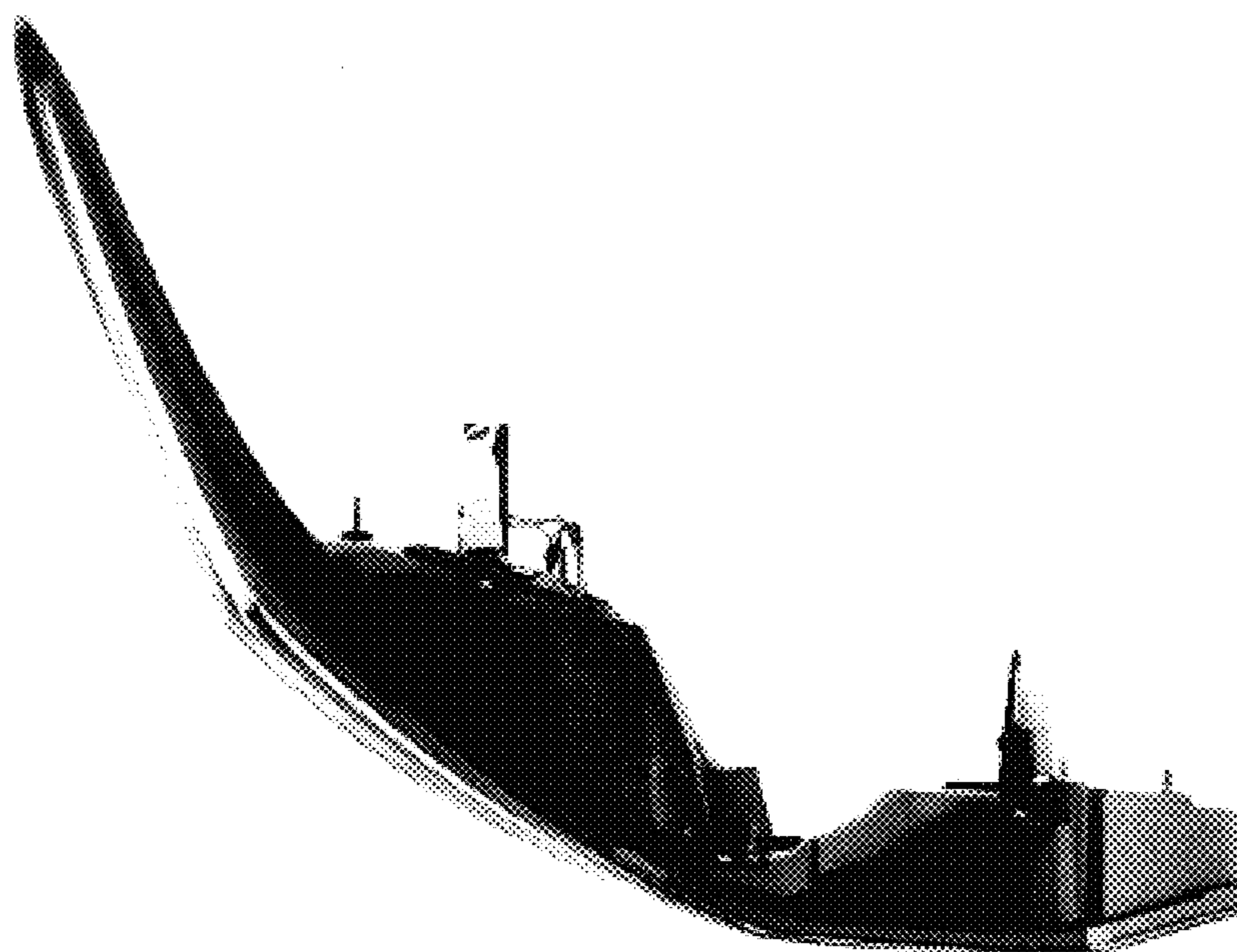

FIG. 4

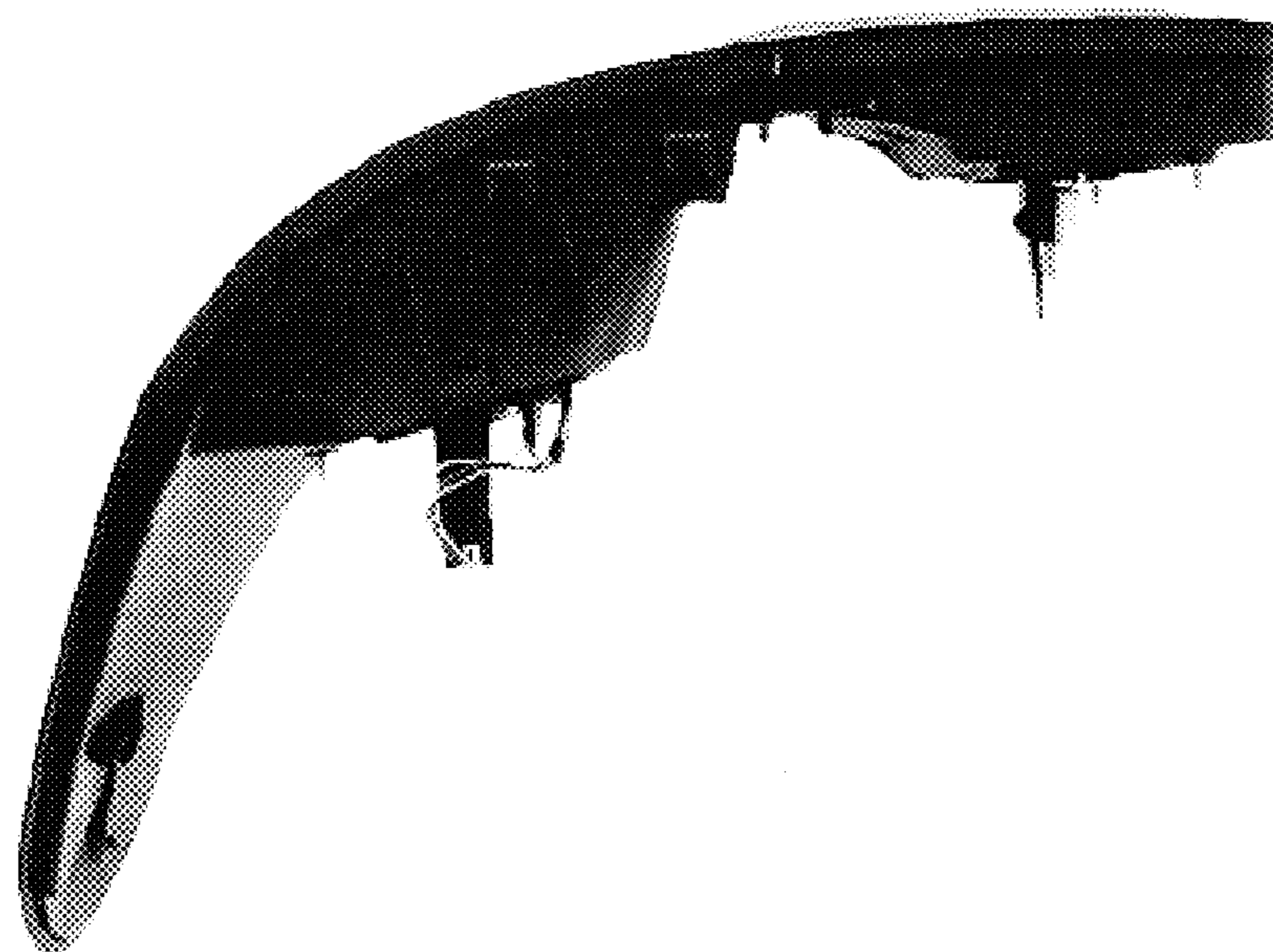

FIG. 5

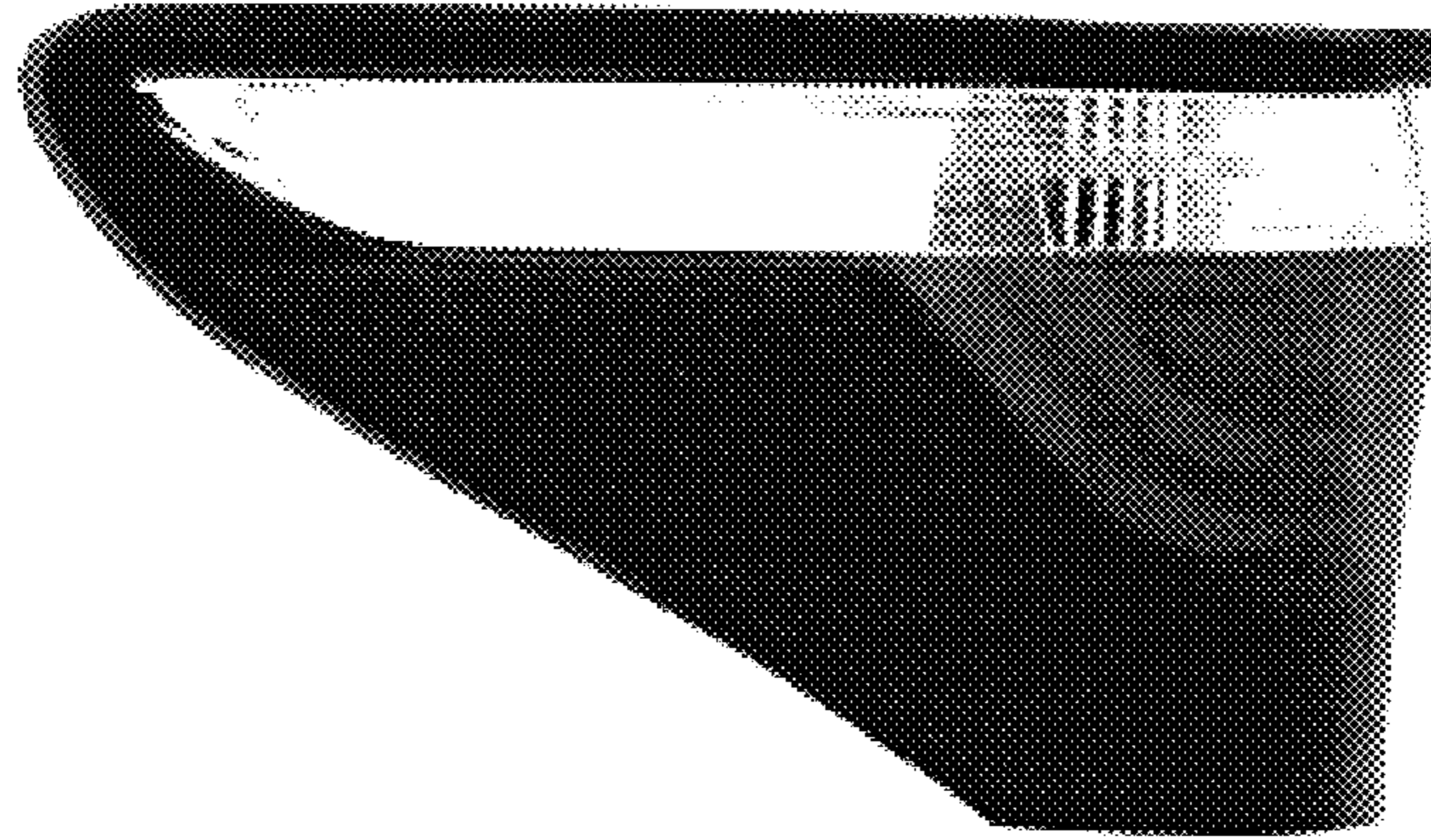

FIG. 6

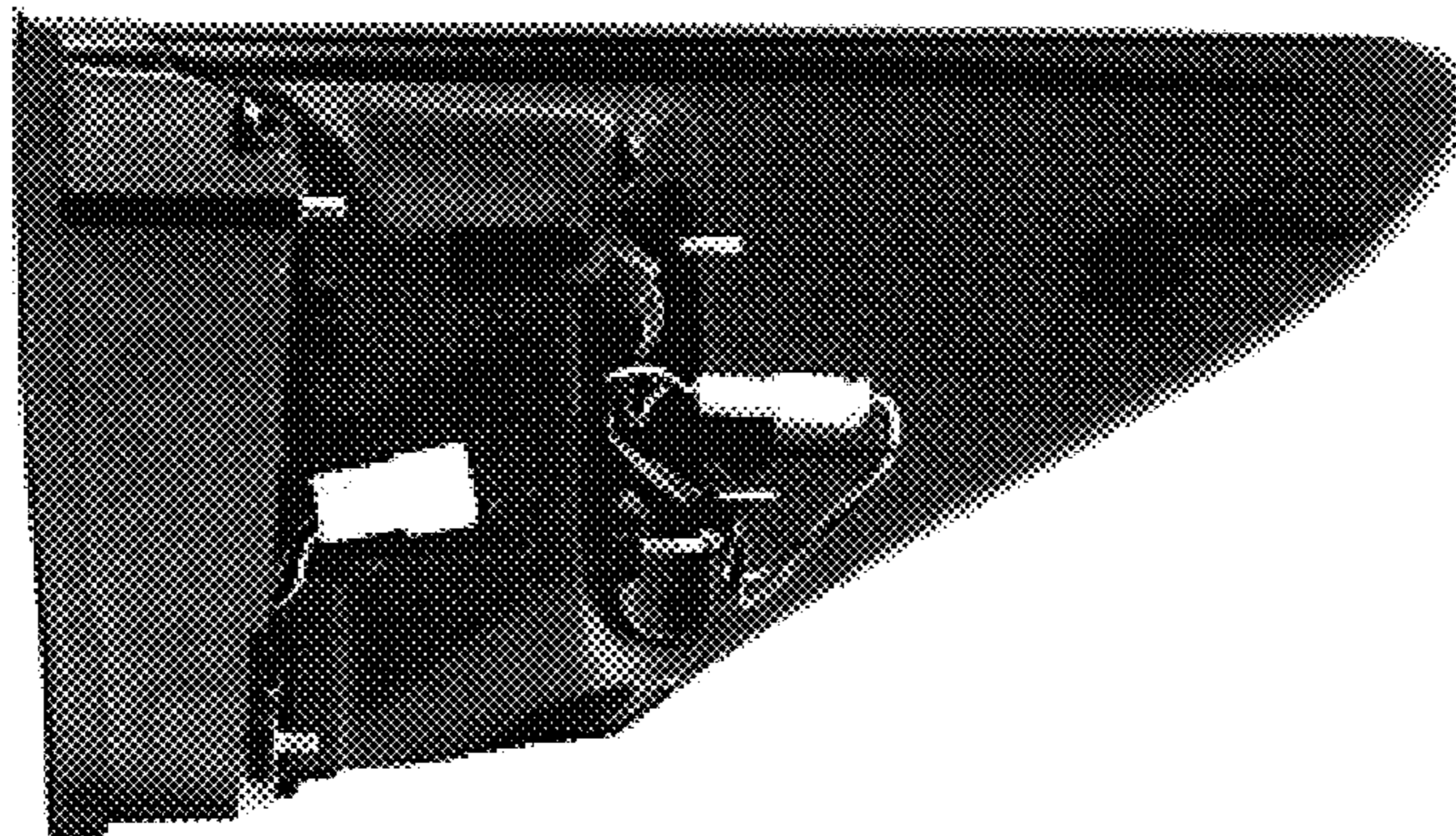

FIG. 7