



US00D531319S

(12) **United States Design Patent** (10) **Patent No.:** **US D531,319 S**
Schein et al. (45) **Date of Patent:** **** Oct. 31, 2006**

(54) **TUBE FRAME FOR ORGAN TRANSPORTER**

(75) Inventors: **Douglas A. Schein**, Des Plaines, IL
(US); **Lee W. Travis**, Littleton, CO
(US)

(73) Assignee: **Organ Recovery Systems**, Des Plaines,
IL (US)

(**) Term: **14 Years**

(21) Appl. No.: **29/179,034**

(22) Filed: **Apr. 4, 2003**

(51) **LOC (8) Cl.** **24-02**

(52) **U.S. Cl.** **D24/216; D24/107**

(58) **Field of Classification Search** D24/111,
D24/216, 108, 133, 107, 121, 128; 435/1.2,
435/284.1, 307.1, 303.1; 62/306, 78, 371;
128/DIG. 26; 604/19

See application file for complete search history.

(56) **References Cited**

U.S. PATENT DOCUMENTS

| | | | |
|-----------|---|---------|----------------|
| 3,406,531 | A | 10/1968 | Swenson et al. |
| 3,545,221 | A | 12/1970 | Swenson et al. |
| 3,607,646 | A | 9/1971 | de Roissart |
| 3,654,085 | A | 4/1972 | Norr et al. |
| 3,660,241 | A | 5/1972 | Michielsen |
| 3,777,507 | A | 12/1973 | Burton et al. |

(Continued)

FOREIGN PATENT DOCUMENTS

| | | |
|----|--------------|---------|
| DE | 38 08 942 | 1/1989 |
| EP | 0 096 997 | 12/1983 |
| EP | 0 376 763 A2 | 7/1990 |
| GB | 1442356 A | 7/1976 |
| JP | 2-258701 | 10/1990 |
| SU | 760972 | 9/1980 |
| WO | WO 91/03934 | 4/1991 |
| WO | WO 91/14364 | 10/1991 |
| WO | 93/00808 | 1/1993 |
| WO | 96/05727 | 2/1996 |
| WO | WO 96/13288 | 5/1996 |

| | | |
|----|-------------|---------|
| WO | WO 96/29865 | 10/1996 |
| WO | WO 96/30111 | 10/1996 |
| WO | WO 97/43899 | 11/1997 |
| WO | WO 97/45527 | 12/1997 |
| WO | WO 99/15011 | 4/1999 |
| WO | WO 00/18226 | 4/2000 |

OTHER PUBLICATIONS

“Organ Preservation”, J.H. Southard, Ph.D. and F.O. Belzer, M.D., *Principles of Organ Transplantation*, Chapter 10, pp. 194–215, 1989.

“Organko Servierungsmachine OKM 82”, Von Dietmer Scholz et al., East German Article, 1983.

(Continued)

Primary Examiner—Ian Simmons

Assistant Examiner—Christopher Lee

(74) *Attorney, Agent, or Firm*—Oliff & Berridge, PLC

(57) **CLAIM**

The ornamental design for a tube frame for organ transporter, as shown and described.

DESCRIPTION

FIG. 1 is a perspective view of a tube frame for organ transporter made of an opaque material;

FIG. 2 is a top view thereof;

FIG. 3 is a bottom view thereof;

FIG. 4 is a front view thereof;

FIG. 5 is a rear view thereof;

FIG. 6 is a left-side view thereof; and

FIG. 7 is a right-side view thereof.

FIG. 8 is a perspective view of the tube frame for organ transporter made of a transparent material;

FIG. 9 is a top view thereof;

FIG. 10 is a bottom view thereof;

FIG. 11 is a front view thereof;

FIG. 12 is a rear view thereof;

FIG. 13 is a left-side view thereof; and,

FIG. 14 is a right-side view thereof.

The broken line showing is for illustrative purposes only and does not form part of the claimed design.

1 Claim, 10 Drawing Sheets

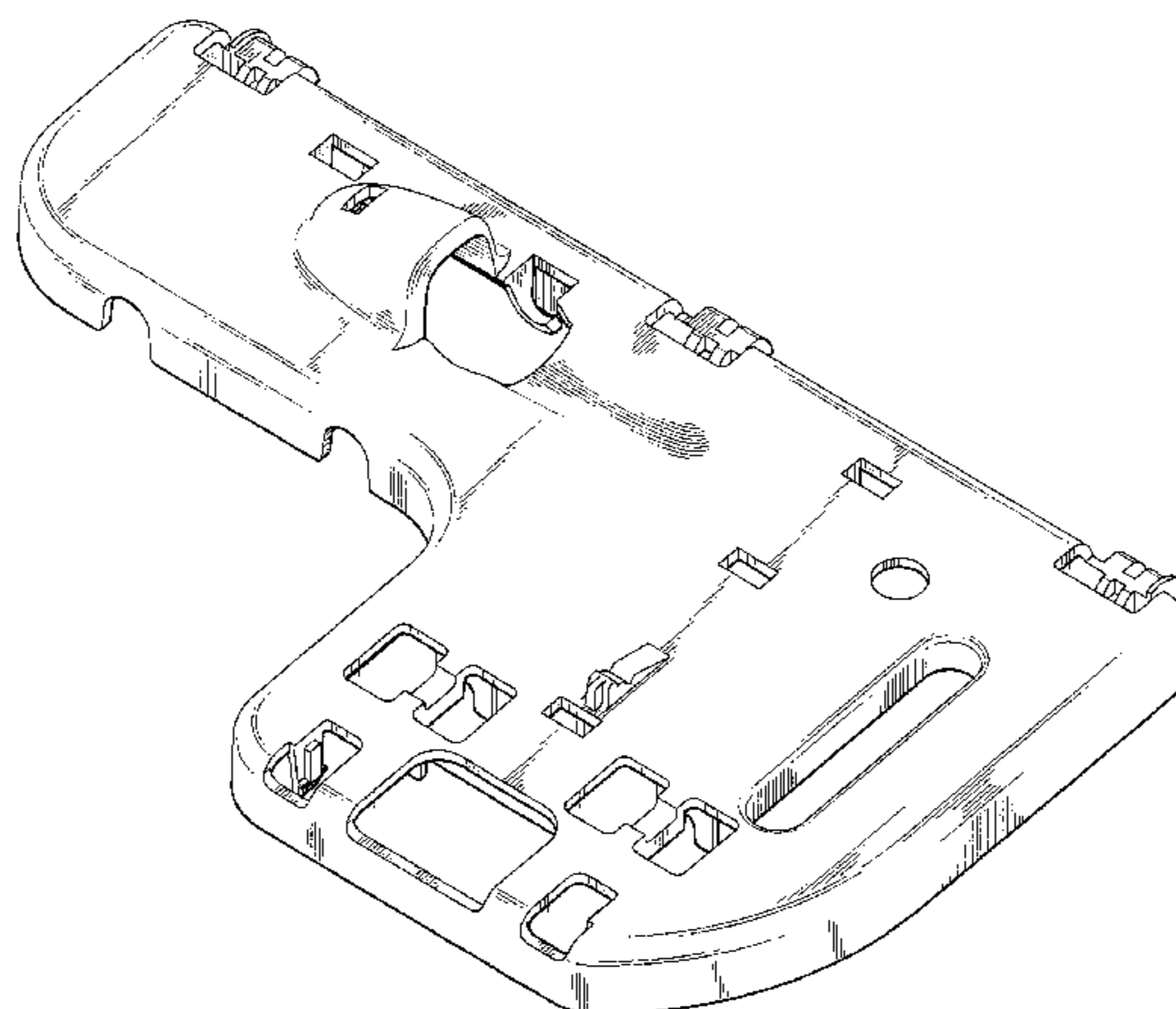

U.S. PATENT DOCUMENTS

3,810,367 A 5/1974 Peterson
 3,843,455 A 10/1974 Bier
 3,877,843 A 4/1975 Fischel
 3,881,990 A 5/1975 Burton et al.
 3,914,954 A 10/1975 Doerig
 3,935,065 A 1/1976 Doerig
 3,995,444 A 12/1976 Clark et al.
 4,186,565 A 2/1980 Toledo-Pereyra
 4,242,883 A 1/1981 Toledo-Pereyra
 4,462,215 A 7/1984 Kuraoka et al.
 4,471,629 A 9/1984 Toledo-Pereyra
 4,473,637 A 9/1984 Guibert
 4,474,016 A 10/1984 Winchell
 4,494,385 A 1/1985 Kuraoka et al.
 4,502,295 A 3/1985 Toledo-Pereyra
 4,723,974 A 2/1988 Ammerman
 4,745,759 A 5/1988 Bauer et al.
 4,766,740 A 8/1988 Bradley et al.
 4,837,390 A 6/1989 Reneau
 4,951,482 A 8/1990 Gilbert
 4,958,506 A 9/1990 Guilhem et al.
 5,141,847 A 8/1992 Sugimachi et al.
 5,157,930 A 10/1992 McGhee et al.
 5,217,860 A 6/1993 Fahy et al.
 5,285,657 A 2/1994 Bacchi et al.
 5,326,706 A 7/1994 Yland et al.
 D350,823 S * 9/1994 Lanigan D24/111
 5,356,771 A 10/1994 O'Dell
 5,362,622 A 11/1994 O'Dell et al.
 5,383,854 A 1/1995 Safar et al.
 5,385,821 A 1/1995 O'Dell et al.
 D357,312 S * 4/1995 Riquier et al. D24/111
 5,434,045 A 7/1995 Jost

5,472,876 A 12/1995 Fahy
 D367,323 S * 2/1996 Carr et al. D24/111
 5,586,438 A 12/1996 Fahy
 5,681,740 A 10/1997 Messier et al.
 5,723,282 A 3/1998 Fahy et al.
 5,821,045 A 10/1998 Fahy et al.
 5,856,081 A 1/1999 Fahy
 5,965,433 A 10/1999 Gardetto et al.
 6,046,046 A 4/2000 Hassanein
 D477,867 S * 7/2003 O'Mahony et al. D24/108
 6,673,594 B1 * 1/2004 Owen et al. 435/284.1
 2004/0235142 A1 * 11/2004 Schein et al. 435/284.1

OTHER PUBLICATIONS

“Preservation of Cerebral Function During Circulatory Arrest and Resuscitation: Hypothermic Protective Considerations”, Robert J. White, *Resuscitation*, vol. I, pp. 107–115, 1972.
 “Storage and Transport of Heart and Heart–Lung Donor Organs With Inflatable Cushions and Eutectoid Cooling”, D.R. Wheeldon et al., *The Journal of Heart Transplantation*, vol. 7, pp. 265–268, 1988.
 “MOX®–100 Renal Preservation System”, Waters Instruments Medical Group, pp. 2–7, 1992.
 “Organ Perfusion Systems: An Evaluation Criteria”, Fereydoon Sadri, Ph.D., *T.O.P.S. Medical Corporation*, pp. 1–8, 1987.
 Gauke Kootstra et al, “A New Device Towards Intermediate Term Kidney Preservation—An Experimental Study,” 1980, pp. 86–89.

* cited by examiner

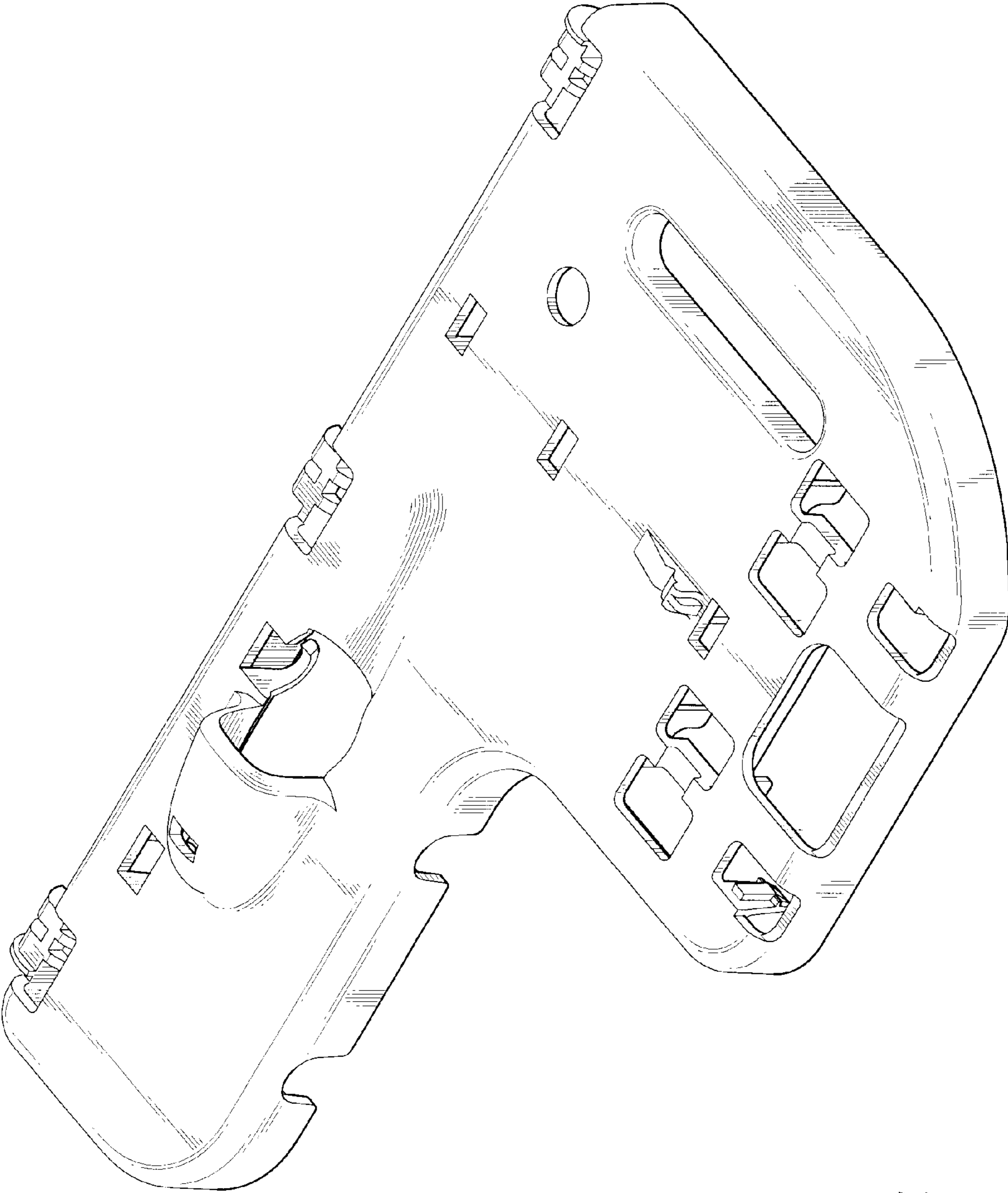

Fig. 1

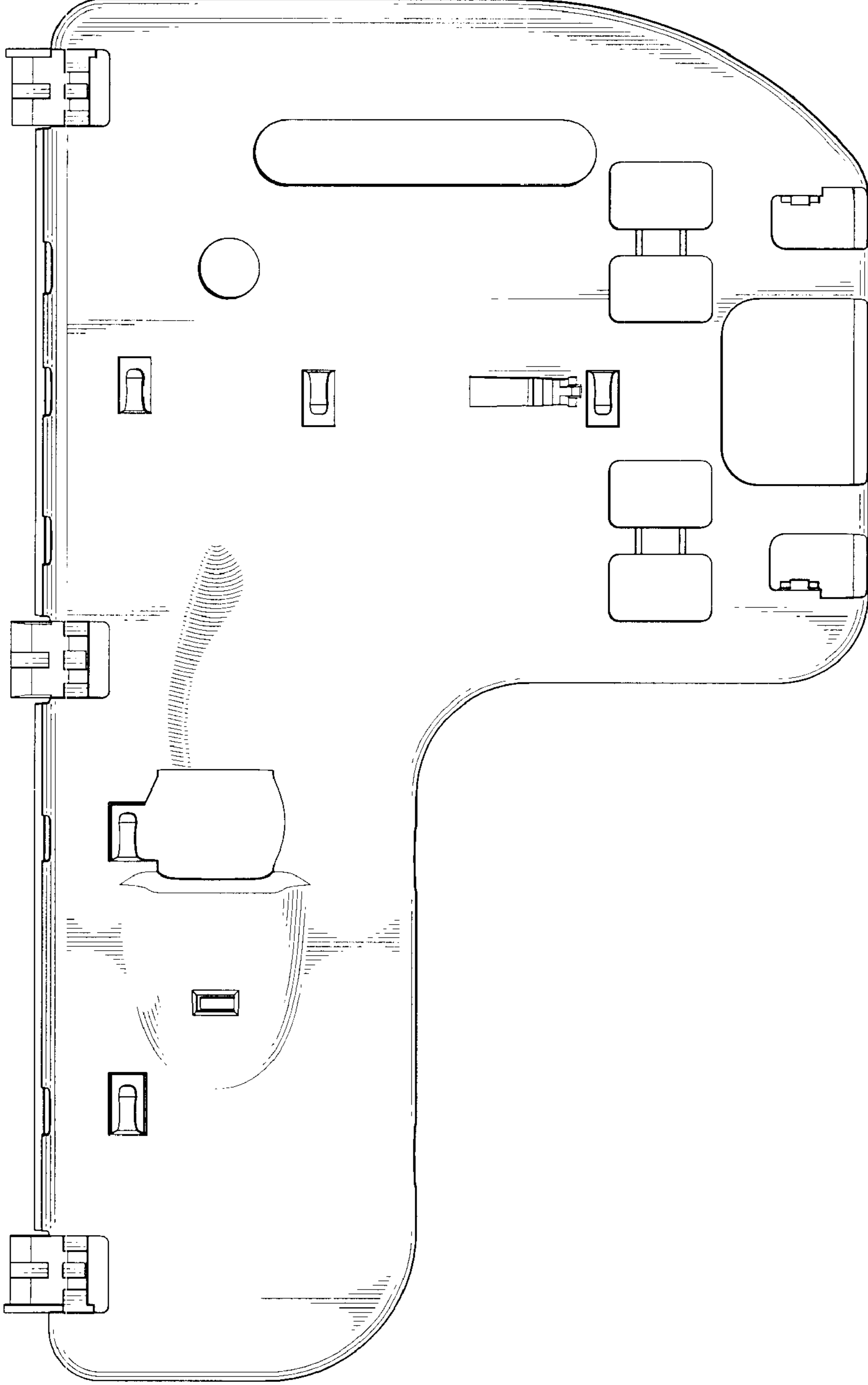

Fig. 2

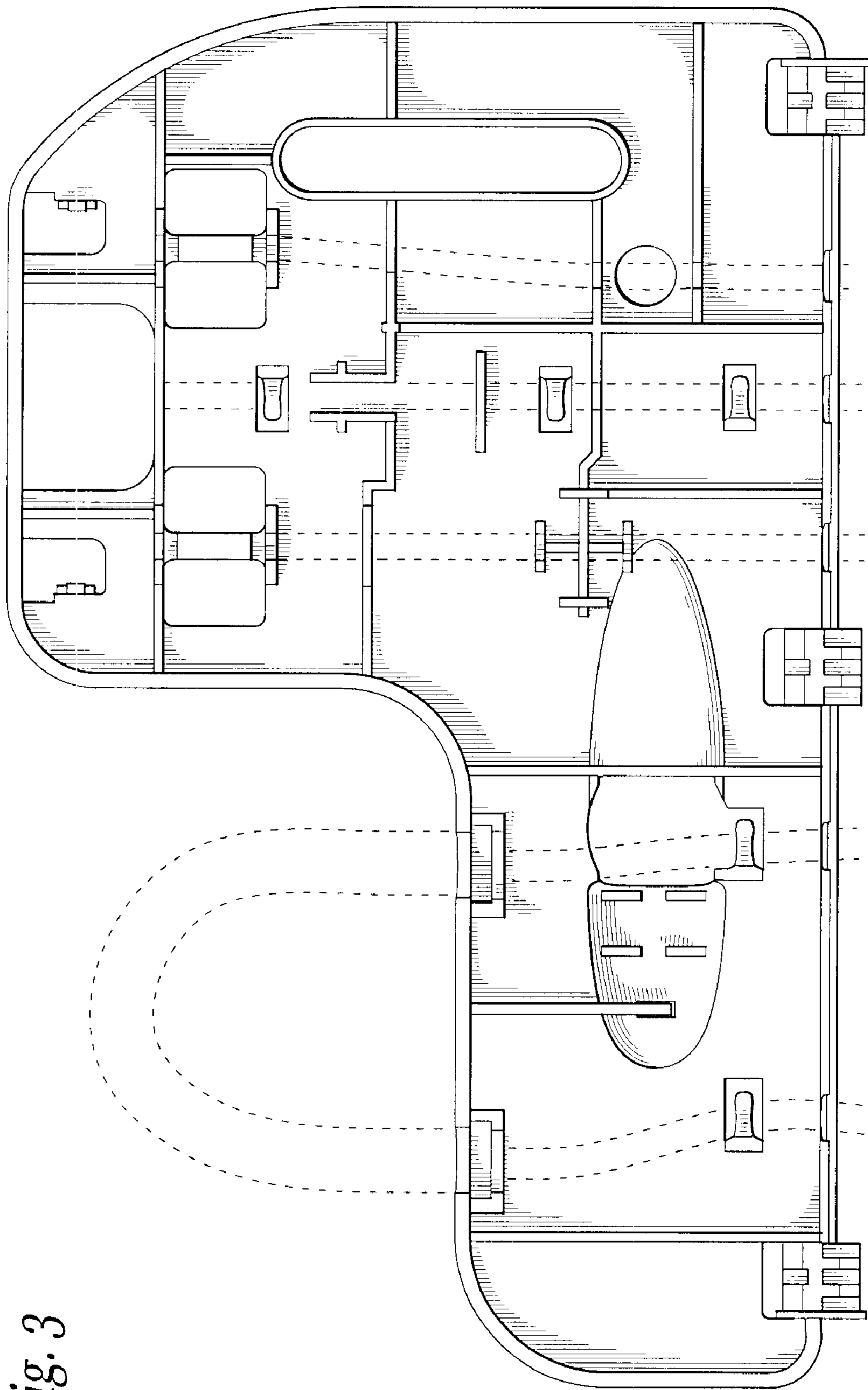

Fig. 3

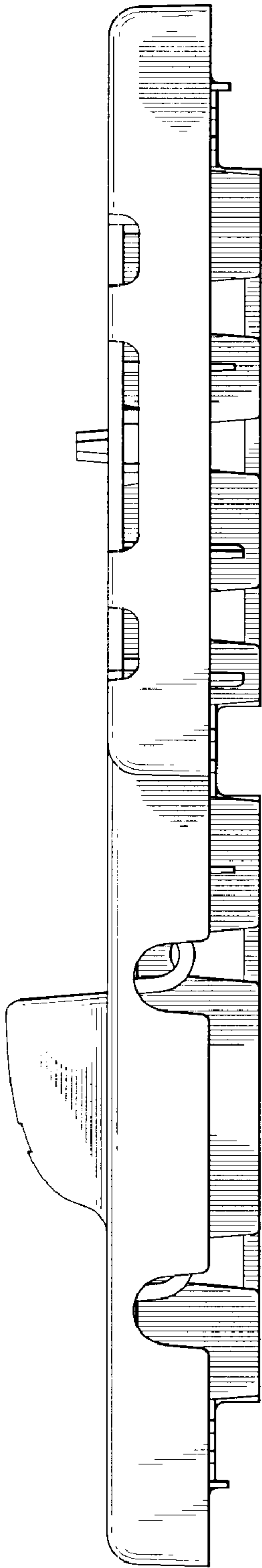

Fig. 4

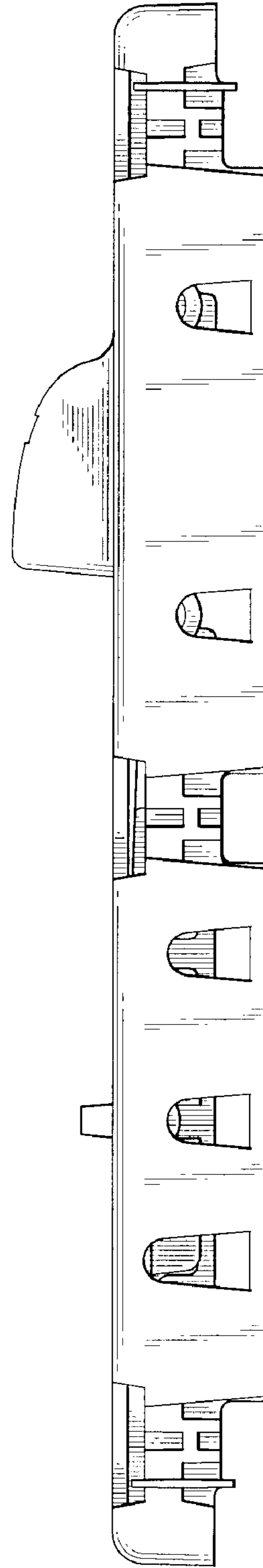

Fig. 5

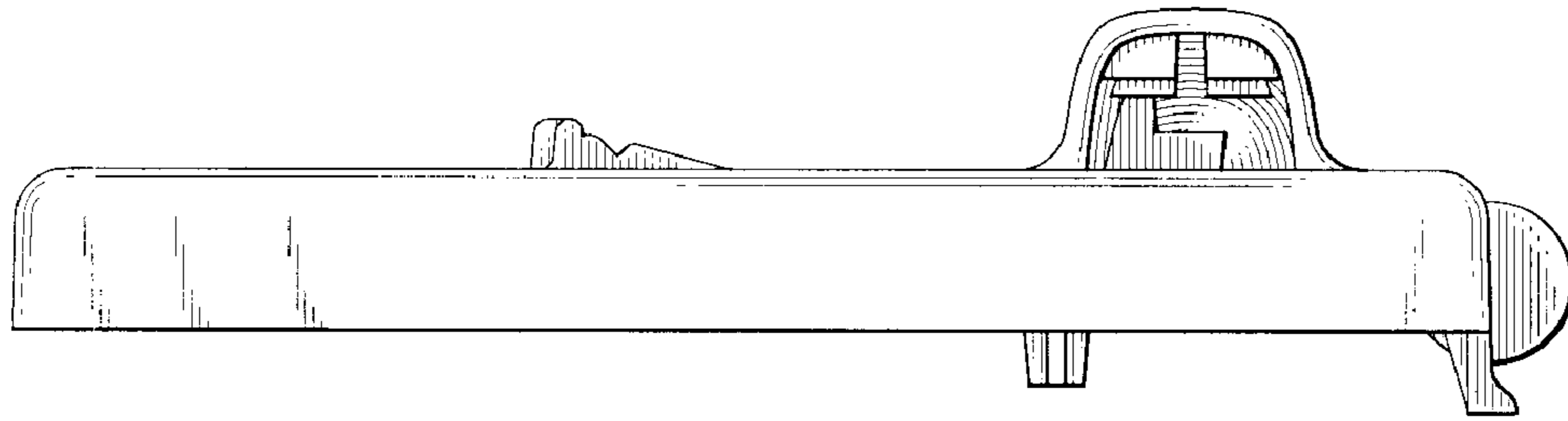

Fig. 6

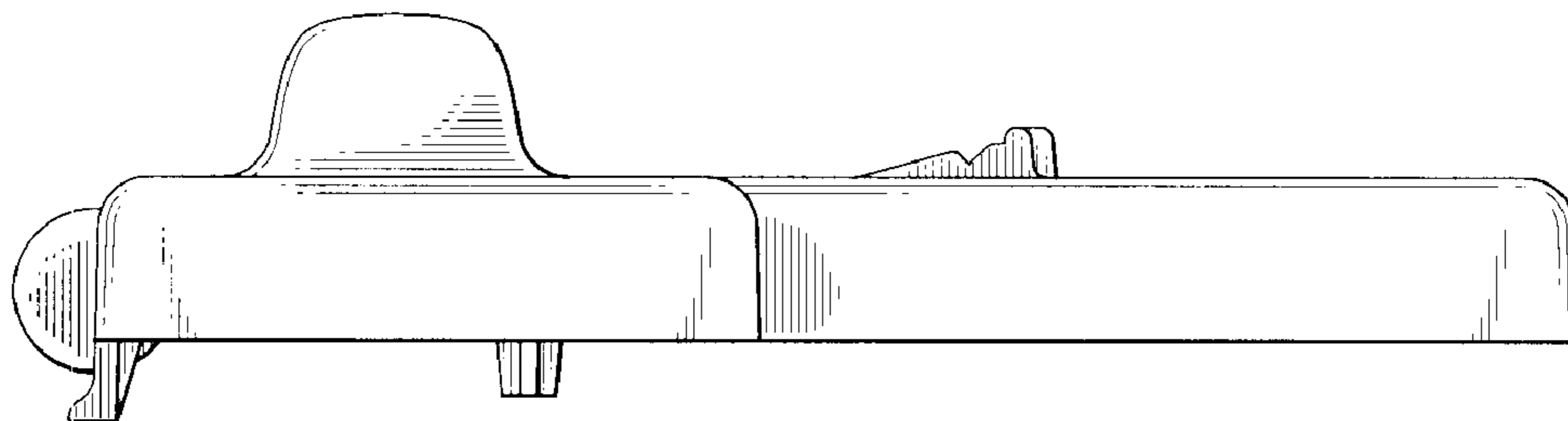

Fig. 7

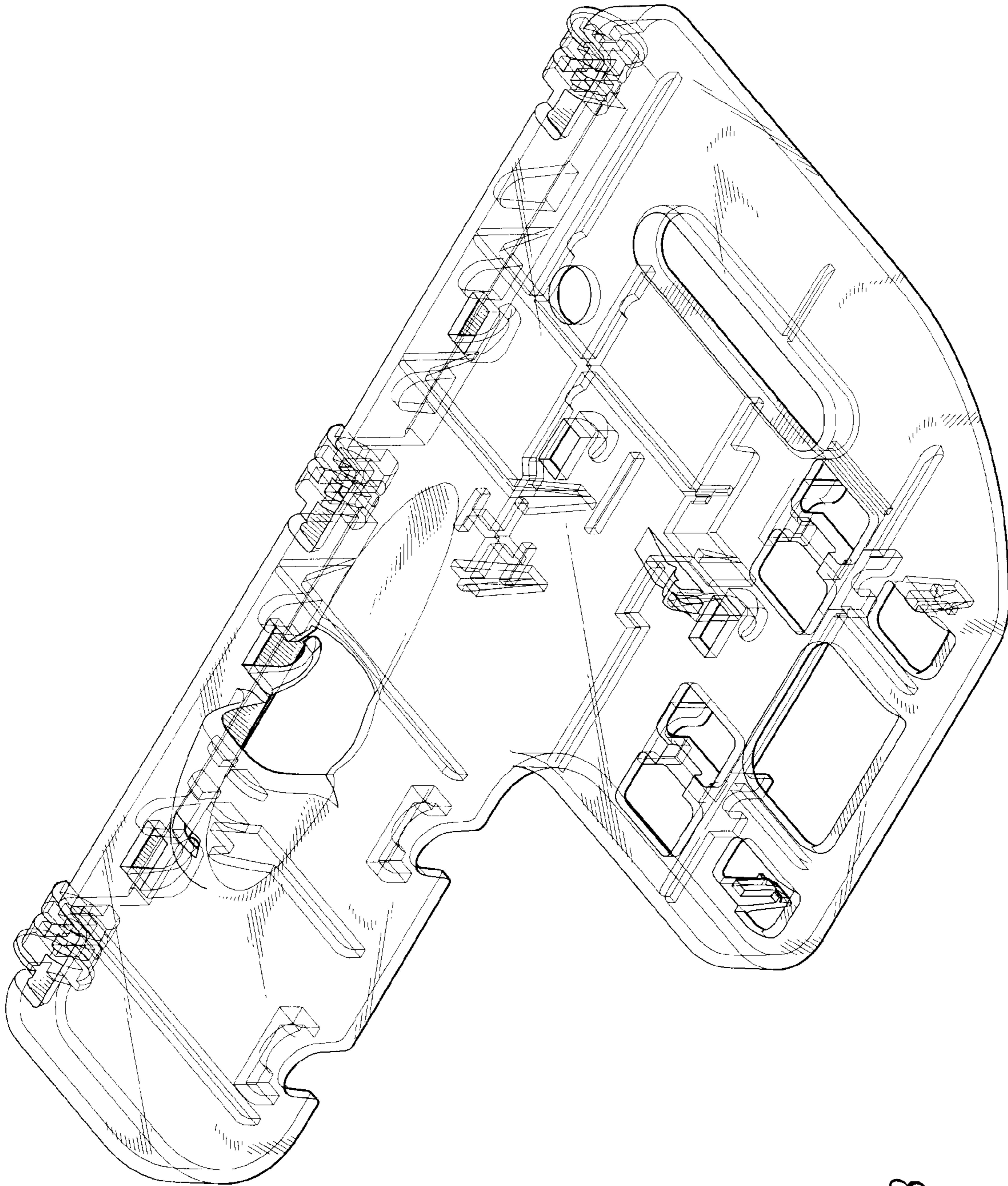

Fig. 8

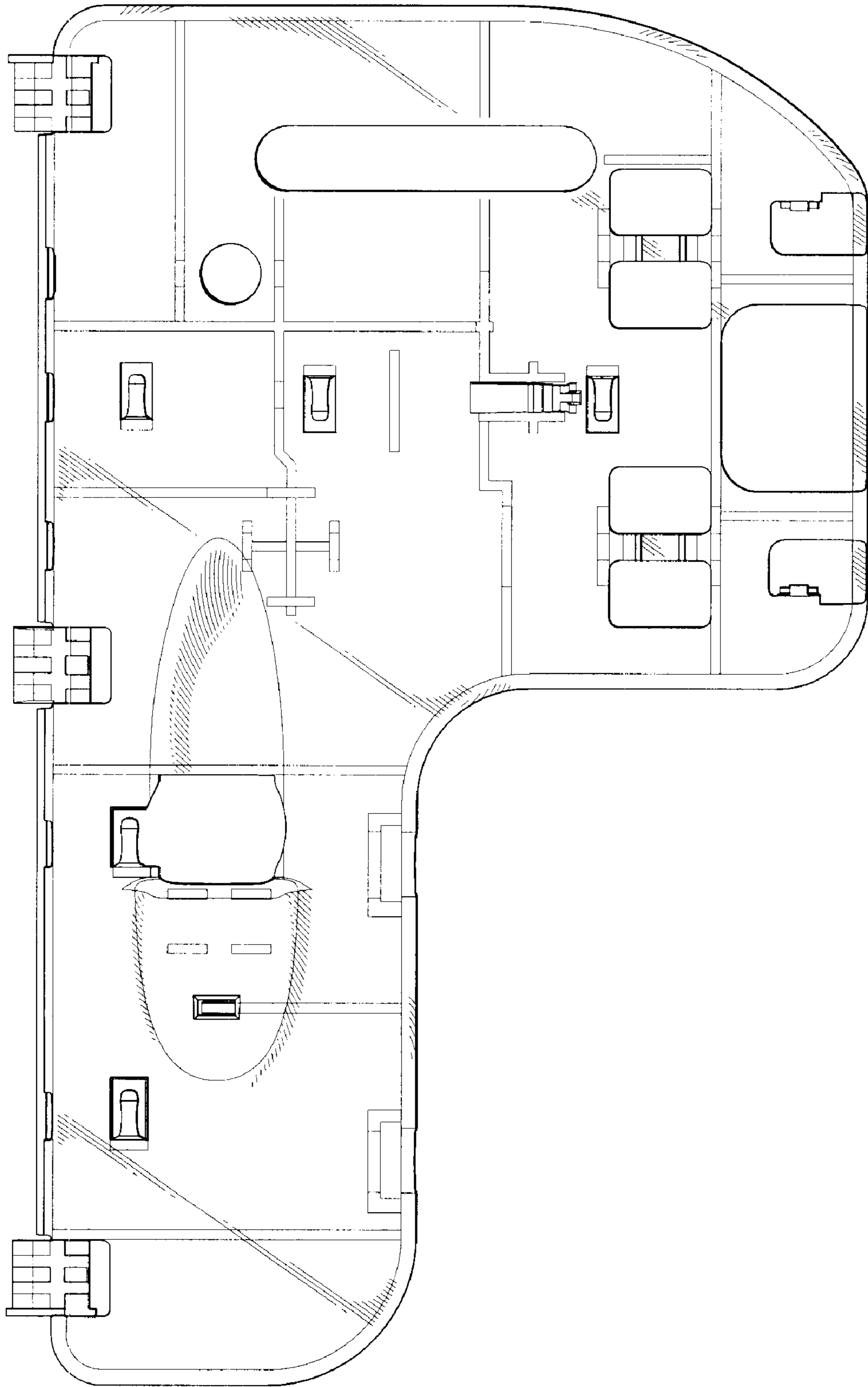

Fig. 9

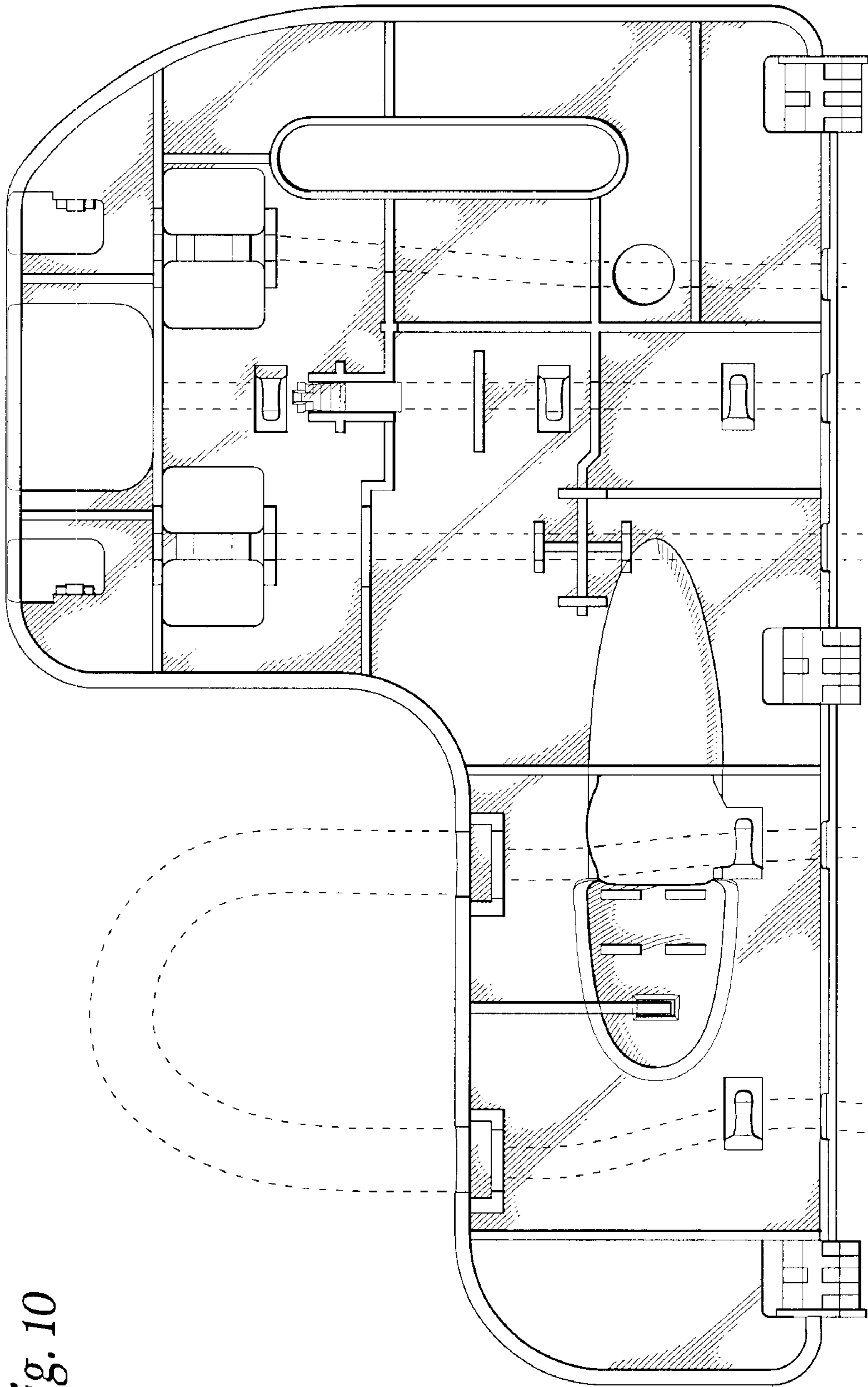

Fig. 10

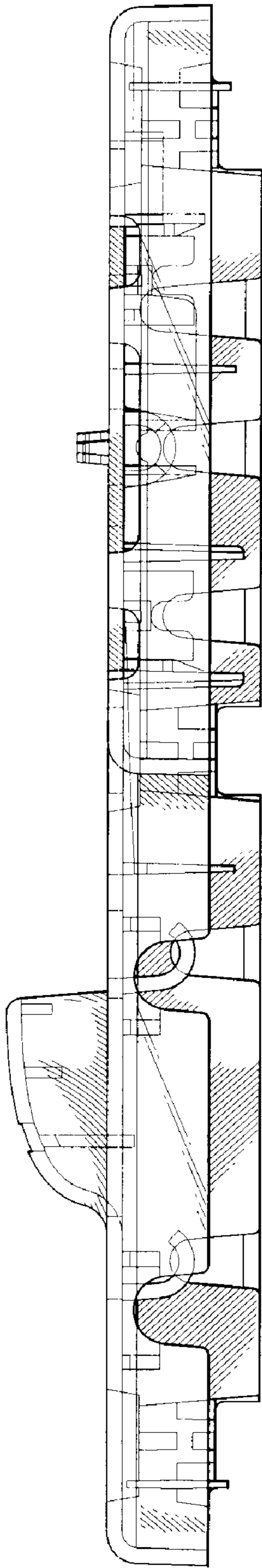

Fig. 11

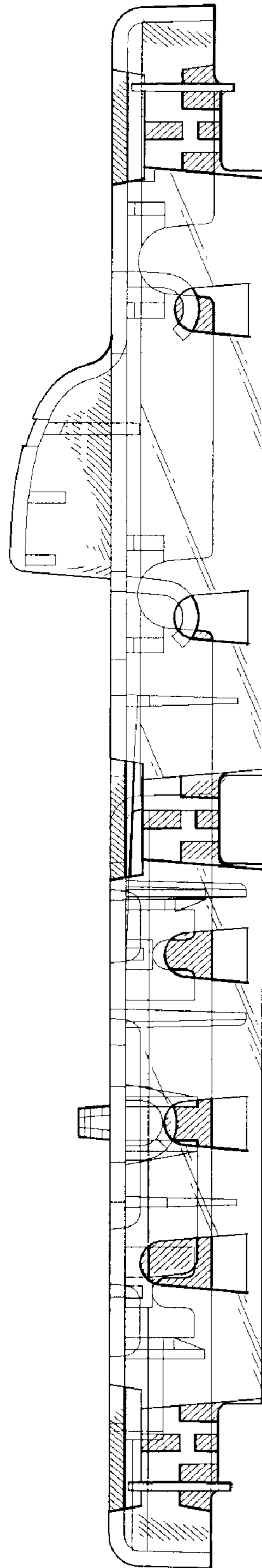

Fig. 12

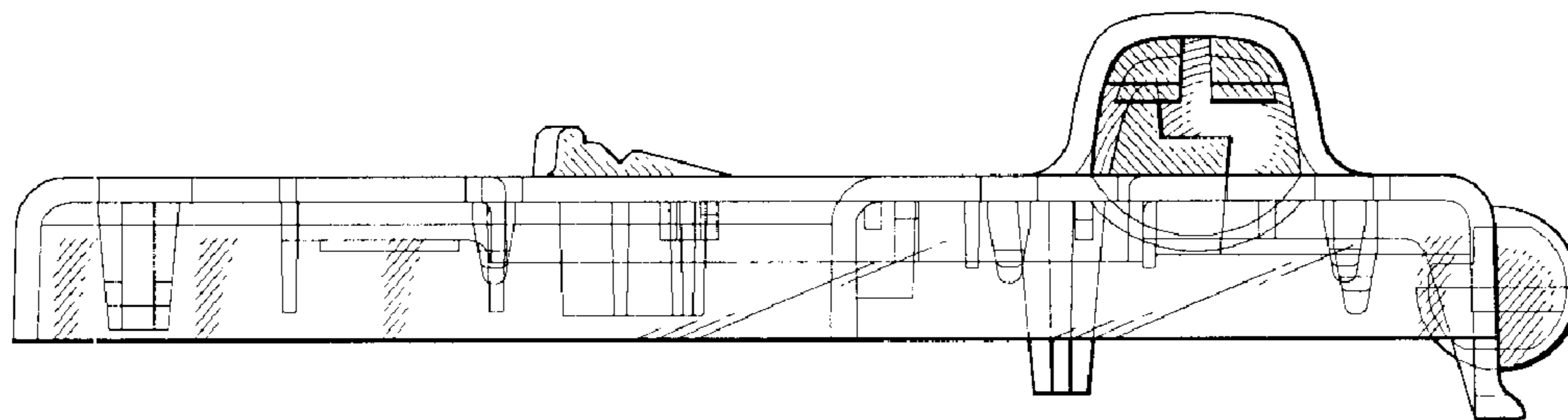

Fig. 13

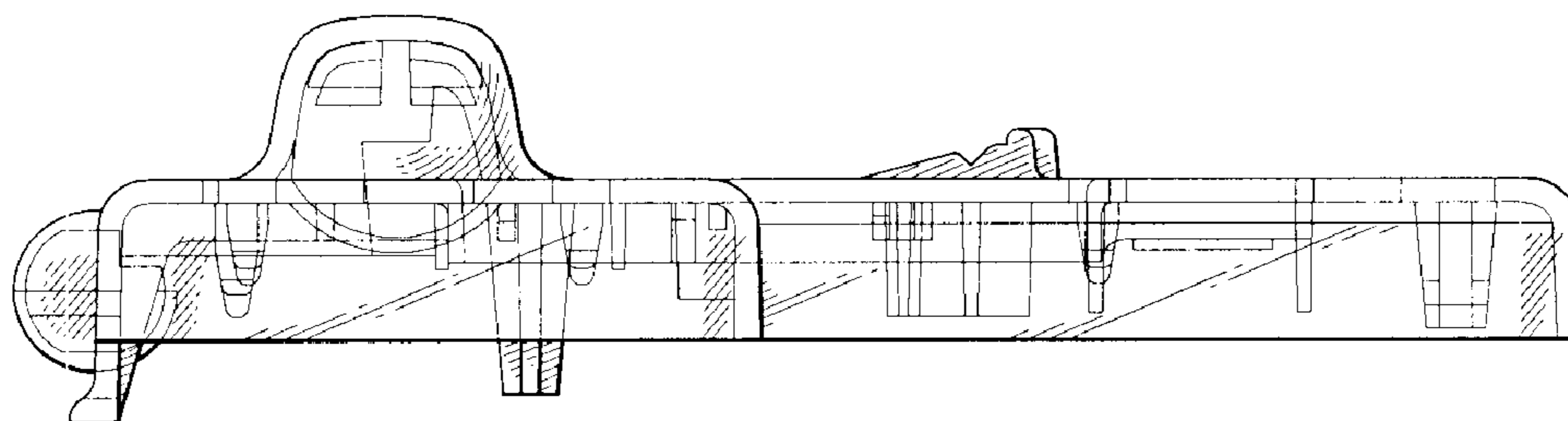

Fig. 14