



US00D531292S

(12) **United States Design Patent**  
**Kim et al.**

(10) **Patent No.:** **US D531,292 S**

(45) **Date of Patent:** **\*\* Oct. 31, 2006**

(54) **AIR-CONDITIONER**

(75) Inventors: **Soo-Hyung Kim**, Yongin (KR);  
**San-Hui Oh**, Seoul (KR); **Shigetada**  
**Mishiro**, Gunma-ken (JP); **Hiroshi**  
**Yamauchi**, Osaka-fu (JP)

(73) Assignees: **Samsung Electronics Co., Ltd.**,  
Gyeonggi-do (KR); **Sanyo Electric Co.,**  
**Ltd.**, Osaka-fu (JP); **Sanyo**  
**Air-Conditioners Co., Ltd.**, Guma-ken  
(JP)

(\*\*) **Term:** **14 Years**

(21) **Appl. No.:** **29/202,109**

(22) **Filed:** **Mar. 25, 2004**

(30) **Foreign Application Priority Data**

Oct. 1, 2003 (JP) ..... 2003-028867

(51) **LOC (8) Cl.** ..... **23-04**

(52) **U.S. Cl.** ..... **D23/351**

(58) **Field of Classification Search** ..... D23/351-354;  
312/236; 62/259.1, 259.4, 262-263, 304;  
454/330-331, 349-350

See application file for complete search history.

(56) **References Cited**

U.S. PATENT DOCUMENTS

4,733,543 A \* 3/1988 Blair ..... 312/236

D321,248 S \* 10/1991 Wilgus et al. .... D23/351  
D322,848 S \* 12/1991 Wilgus et al. .... D23/351  
D417,724 S \* 12/1999 Okamoto et al. .... D23/351  
D448,838 S \* 10/2001 Galeazzi et al. .... D23/354  
D469,525 S \* 1/2003 Giugiaro ..... D23/328

\* cited by examiner

*Primary Examiner*—Brian N Vinson

(74) *Attorney, Agent, or Firm*—Weingarten, Schurgin,  
Gagnebin & Lebovici LLP

(57) **CLAIM**

The ornamental design for an air-conditioner, as shown and described.

**DESCRIPTION**

FIG. 1 is a front elevational view of an air-conditioner showing our new design;

FIG. 2 is a rear elevational view thereof;

FIG. 3 is a top plan view thereof;

FIG. 4 is a bottom plan view thereof;

FIG. 5 is a right-side elevational view thereof;

FIG. 6 is a vertical cross-sectional view thereof, taken through the middle of the unit;

FIG. 7 is an enlarged, fragmentary cross-sectional view thereof, taken along line 7—7 of FIG. 6;

FIG. 8 is a bottom, front and right side perspective view thereof; and,

FIG. 9 is an additional bottom, front and right side perspective view thereof, showing the unit in an operational mode.

**1 Claim, 4 Drawing Sheets**

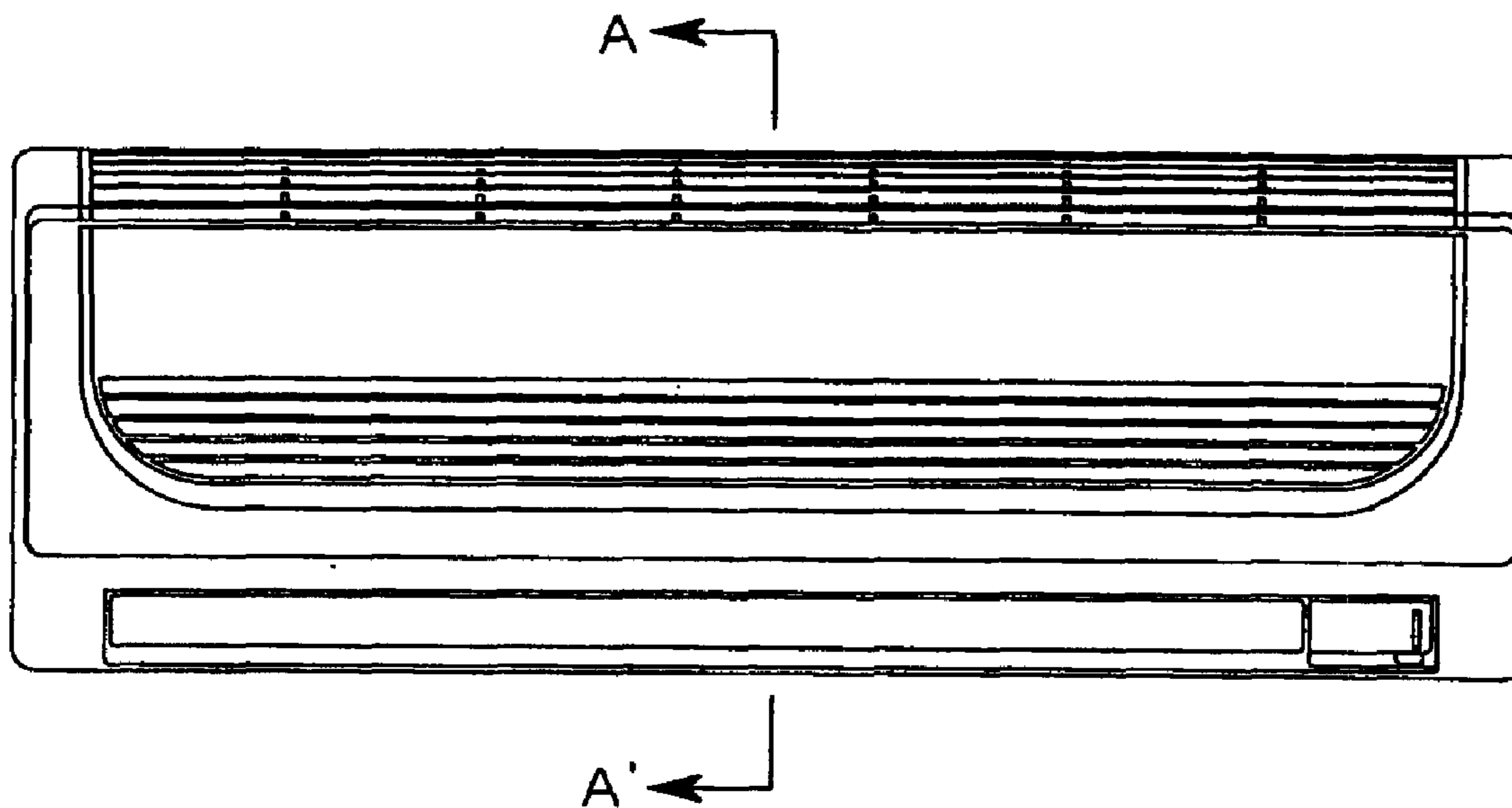

Fig. 1

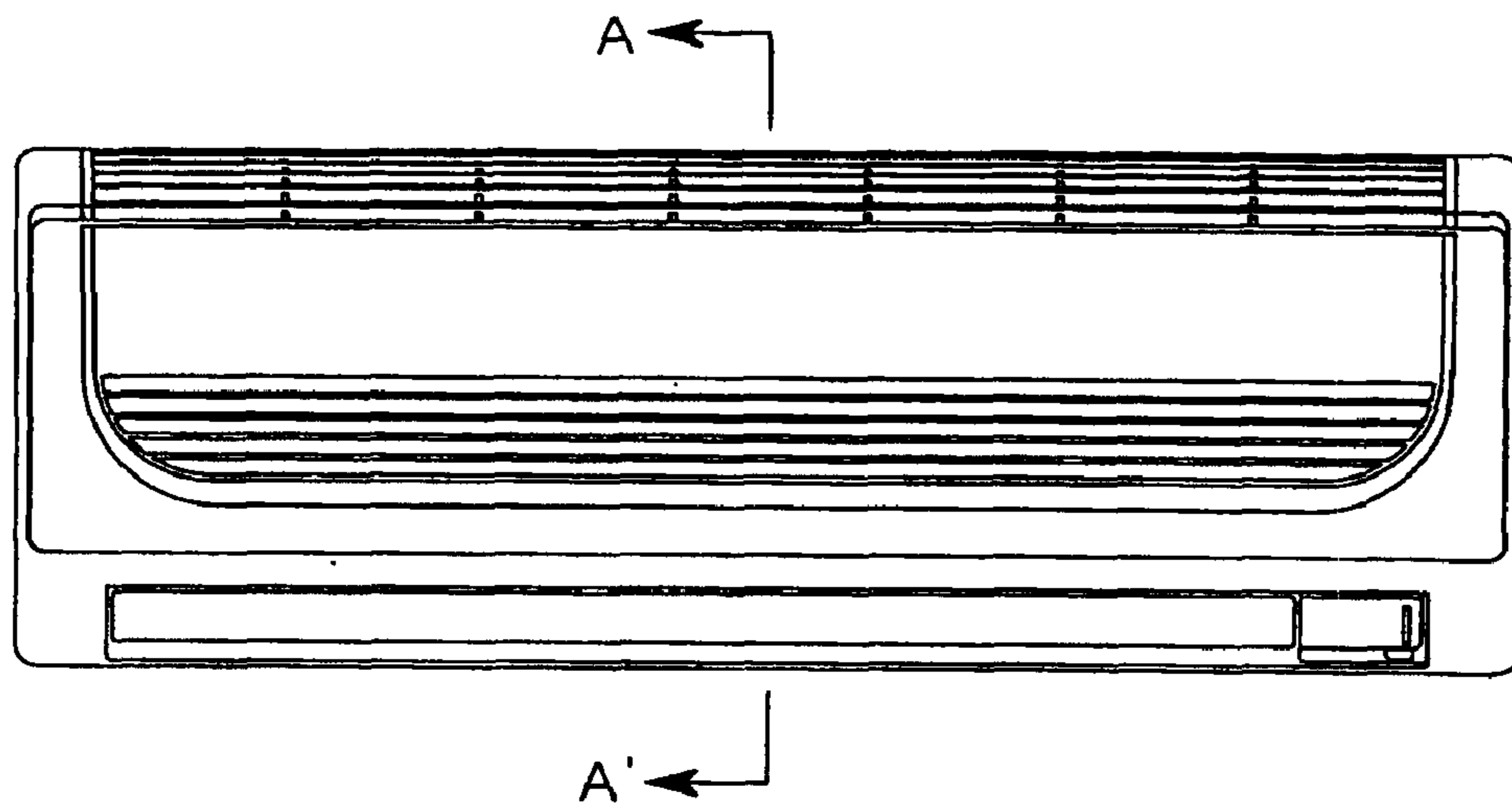

Fig. 2

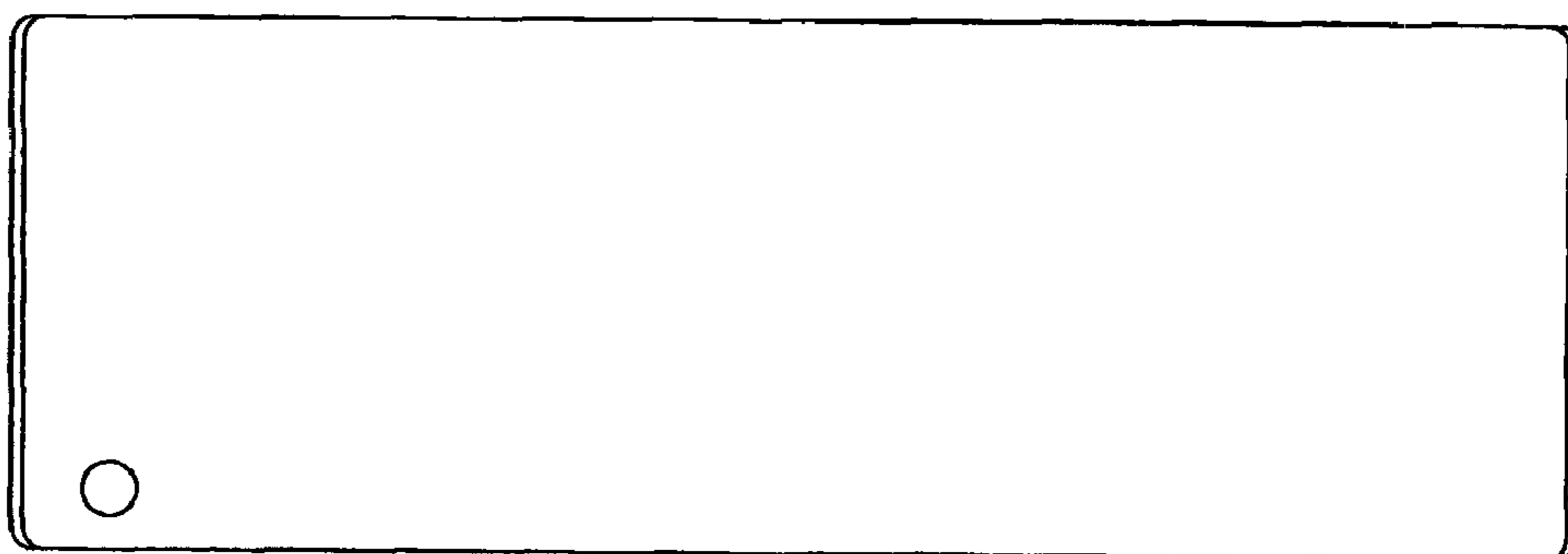

Fig. 3

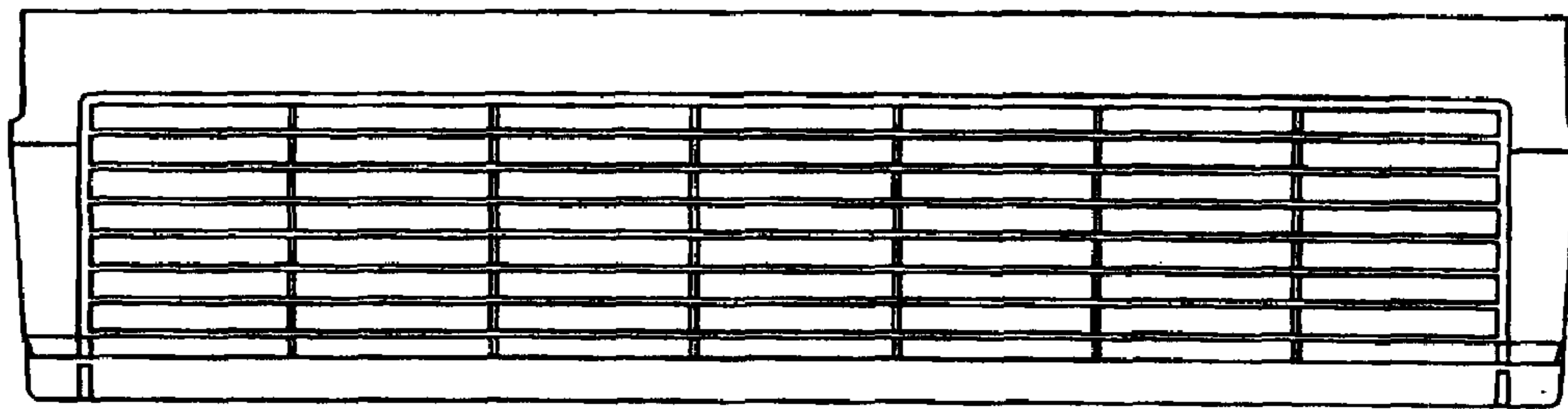
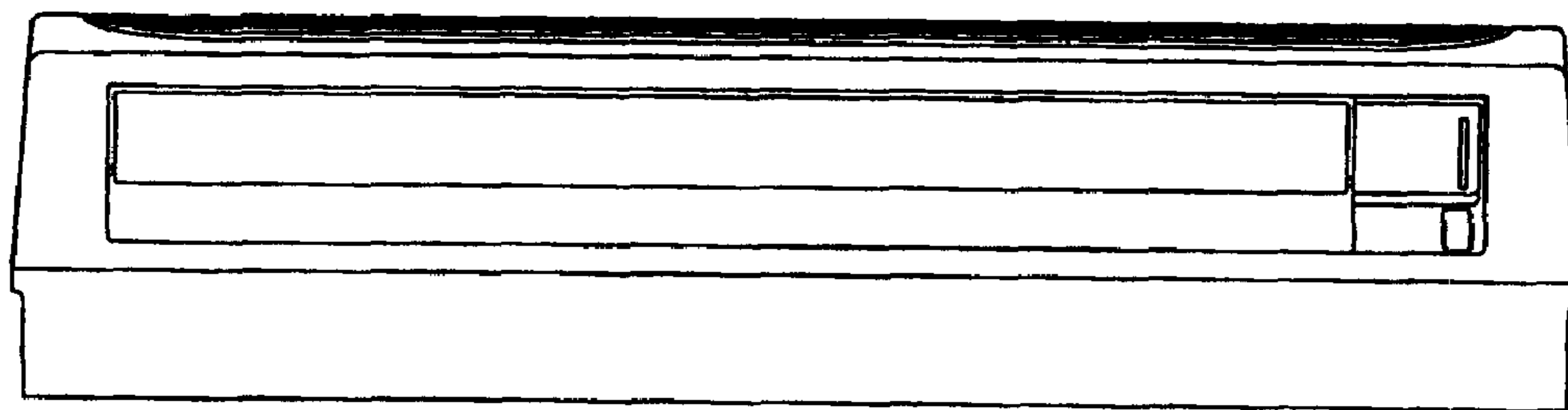

Fig. 4



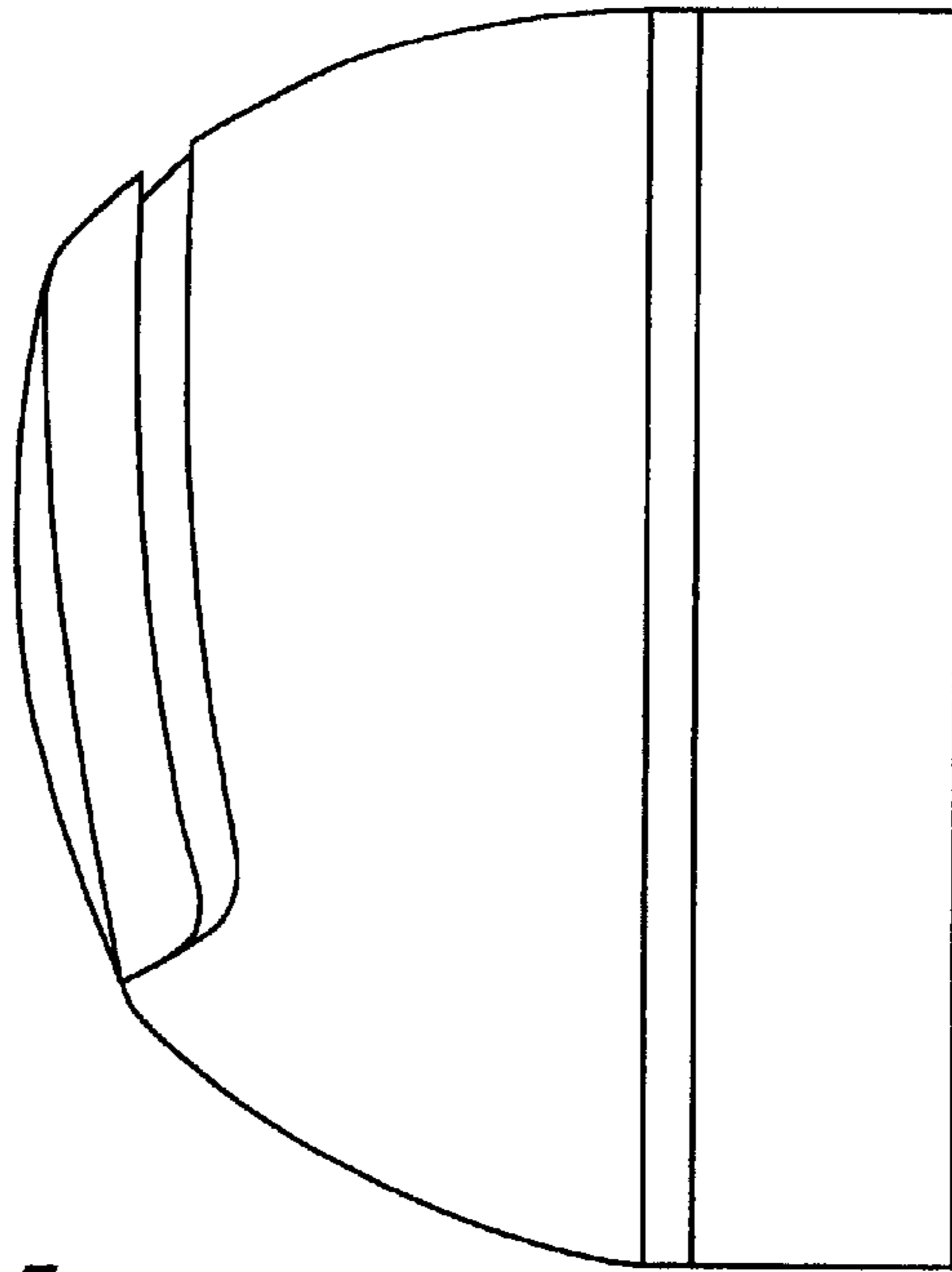

Fig. 5

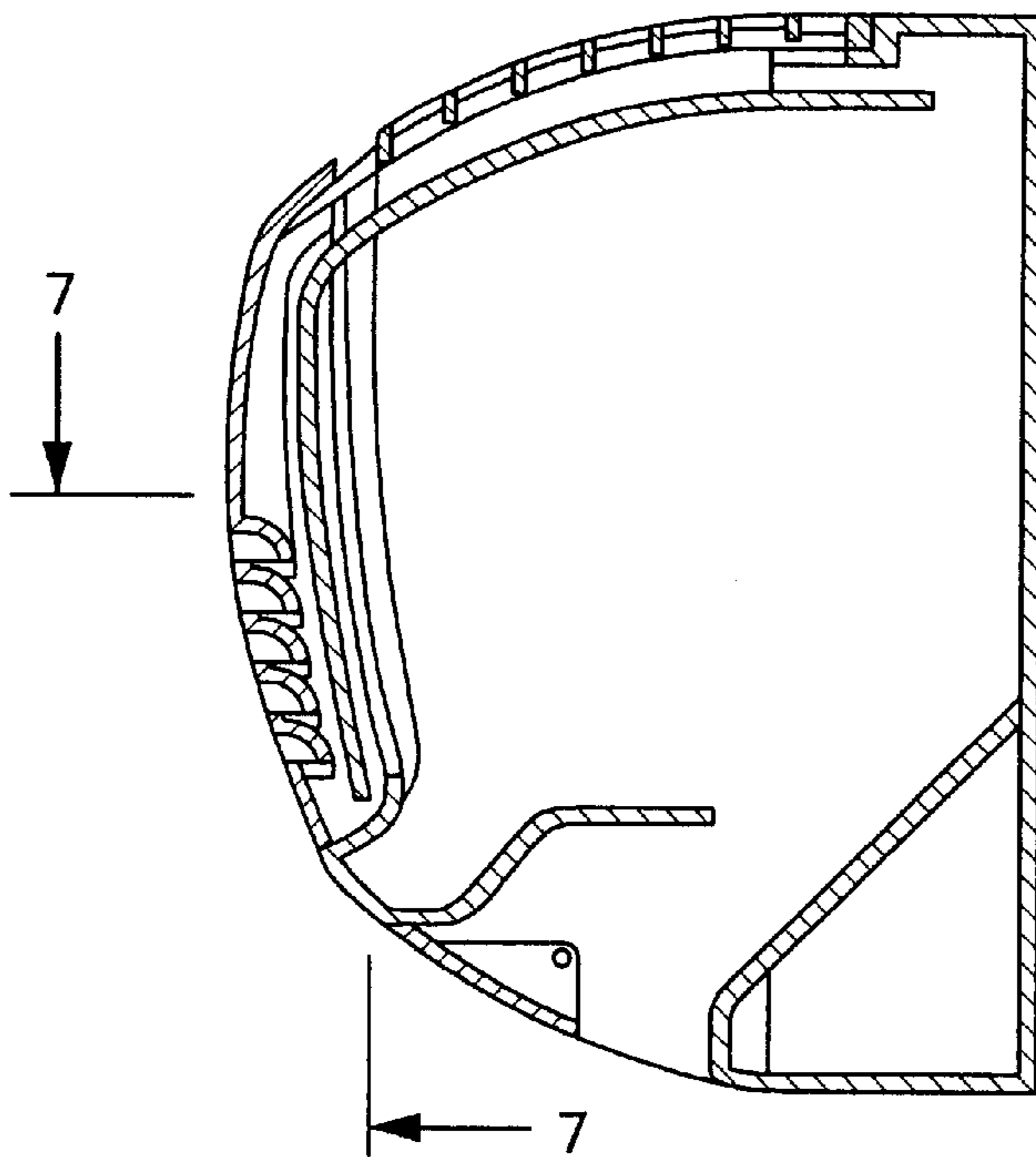

Fig. 6

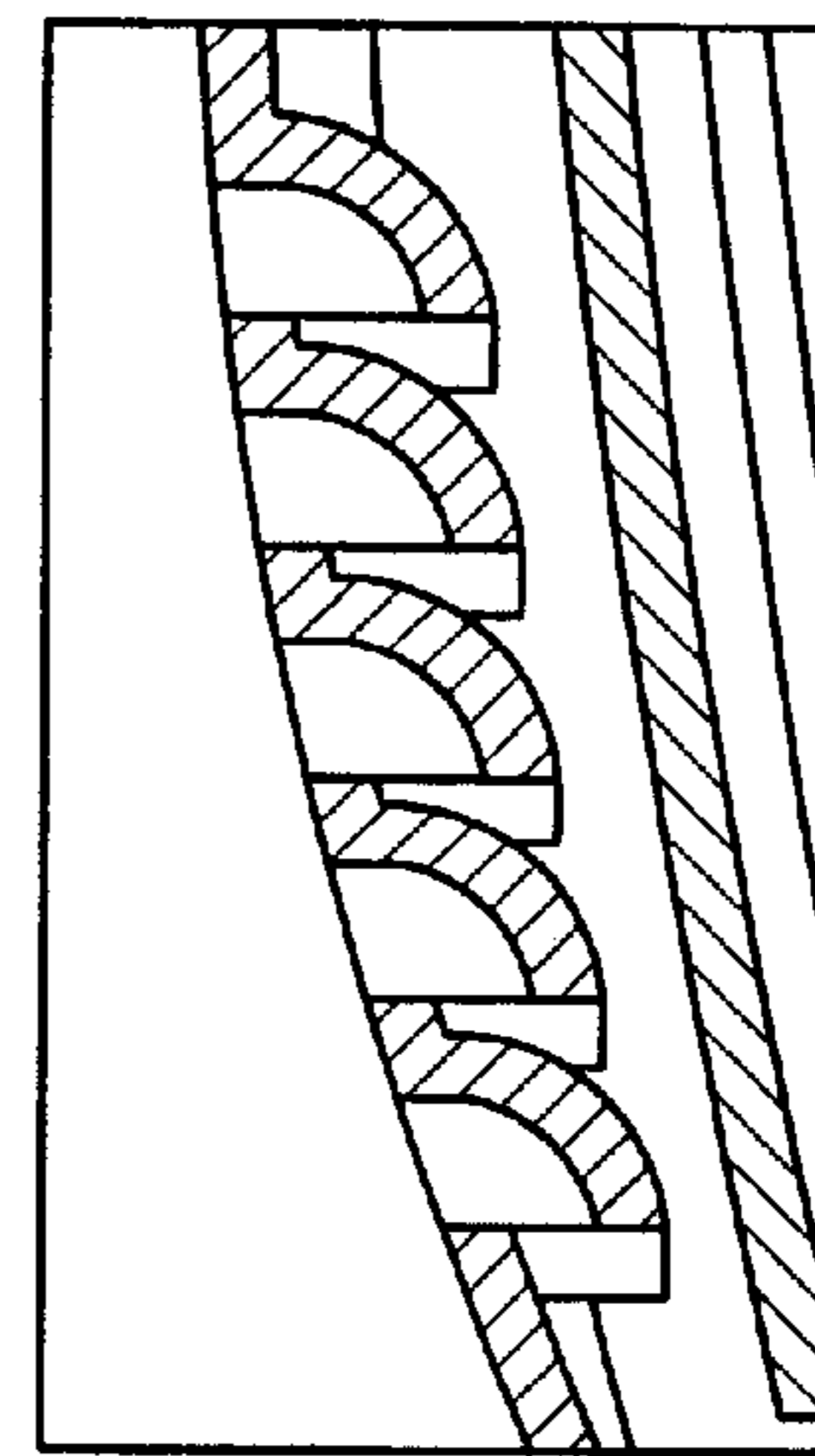

Fig. 7

Fig. 8

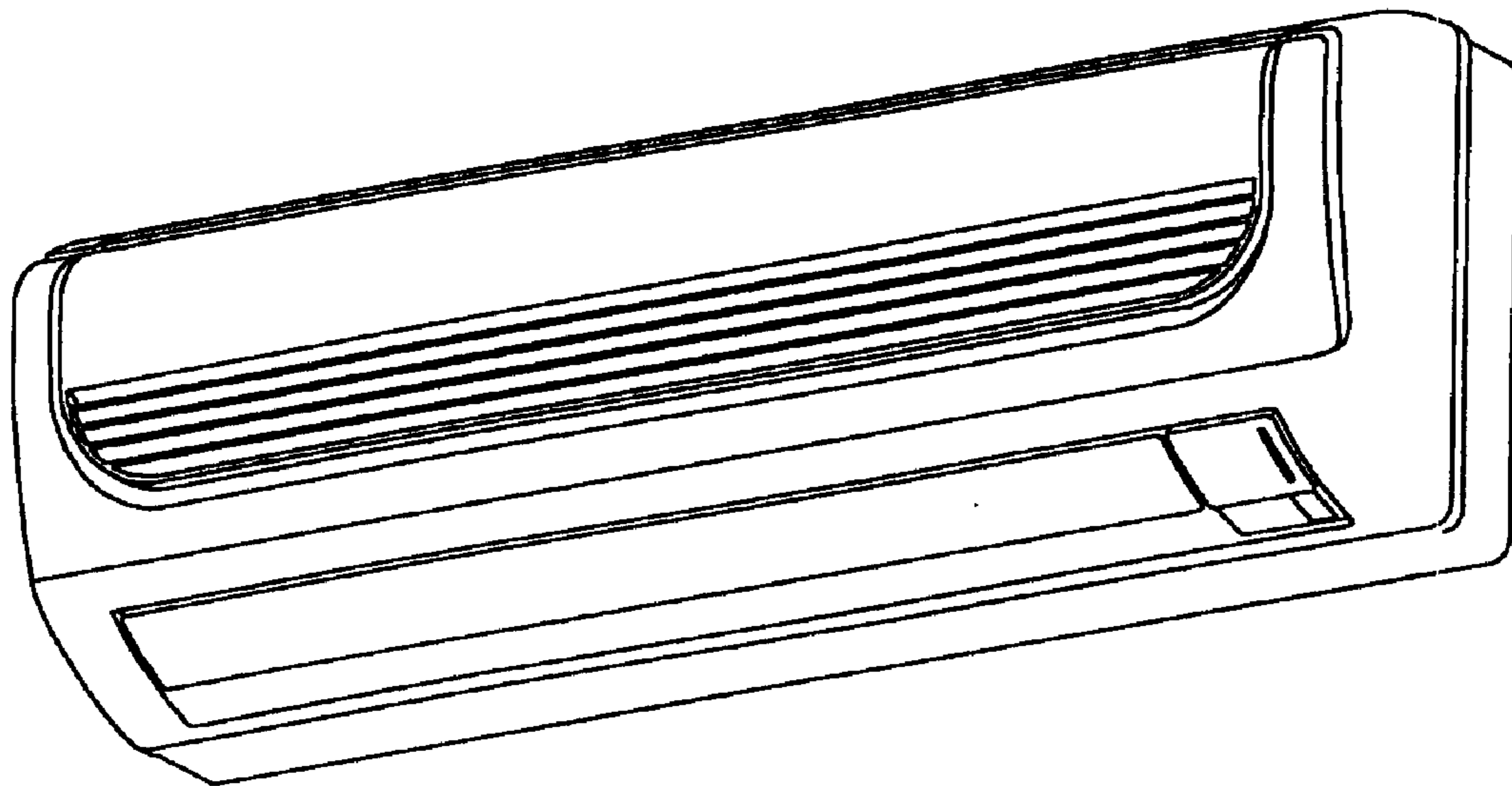

Fig. 9

