



US00D531291S

(12) **United States Design Patent**
Andrews et al.

(10) **Patent No.:** **US D531,291 S**
(45) **Date of Patent:** **** Oct. 31, 2006**

(54) **COMBINED FAN AND NOVELTY ITEM**

D513,798 S * 1/2006 Andrews et al. D23/382

(75) Inventors: **Mark Andrews**, Cary, NC (US); **Mary Andrews**, Cary, NC (US)

* cited by examiner

(73) Assignee: **Upshift Design LLC**, Apex, NC (US)

Primary Examiner—Lisa Lichtenstein
(74) *Attorney, Agent, or Firm*—Epstein Drangel Bazerman & James, LLP; Robert L. Epstein

(**) Term: **14 Years**

(57) **CLAIM**

(21) Appl. No.: **29/214,203**

The ornamental design for a combined fan and novelty item, substantially as shown and described.

(22) Filed: **Sep. 28, 2004**

DESCRIPTION

(51) **LOC (8) Cl.** **23-04**

(52) **U.S. Cl.** **D23/328**

(58) **Field of Classification Search** D23/328,
D23/378, 382, 370; D11/157; D20/29; D18/24,
D18/29; 416/246, 247 R, 63
See application file for complete search history.

FIG. 1 is an isometric view showing the front, top, and one side of our invention.

FIG. 2 is a reduced elevation view of the front of our invention.

FIG. 3 is a reduced elevation view of the first side of our invention.

FIG. 4 is a reduced elevation view of the top of our invention.

FIG. 5 is a reduced elevation view of the rear of our invention.

FIG. 6 is a reduced elevation view of the second side of our invention; and,

FIG. 7 is a reduced plan view of the bottom of our invention.

(56) **References Cited**

U.S. PATENT DOCUMENTS

222,118 A	*	12/1879	Newnham	381/417
D248,936 S	*	8/1978	Lohan	D11/157
D304,458 S	*	11/1989	Mowry, Jr.	D18/24
D315,018 S	*	2/1991	Wang	D23/382
D351,901 S	*	10/1994	Boruch et al.	D23/328
D510,617 S	*	10/2005	Andrews et al.	D23/328

1 Claim, 3 Drawing Sheets

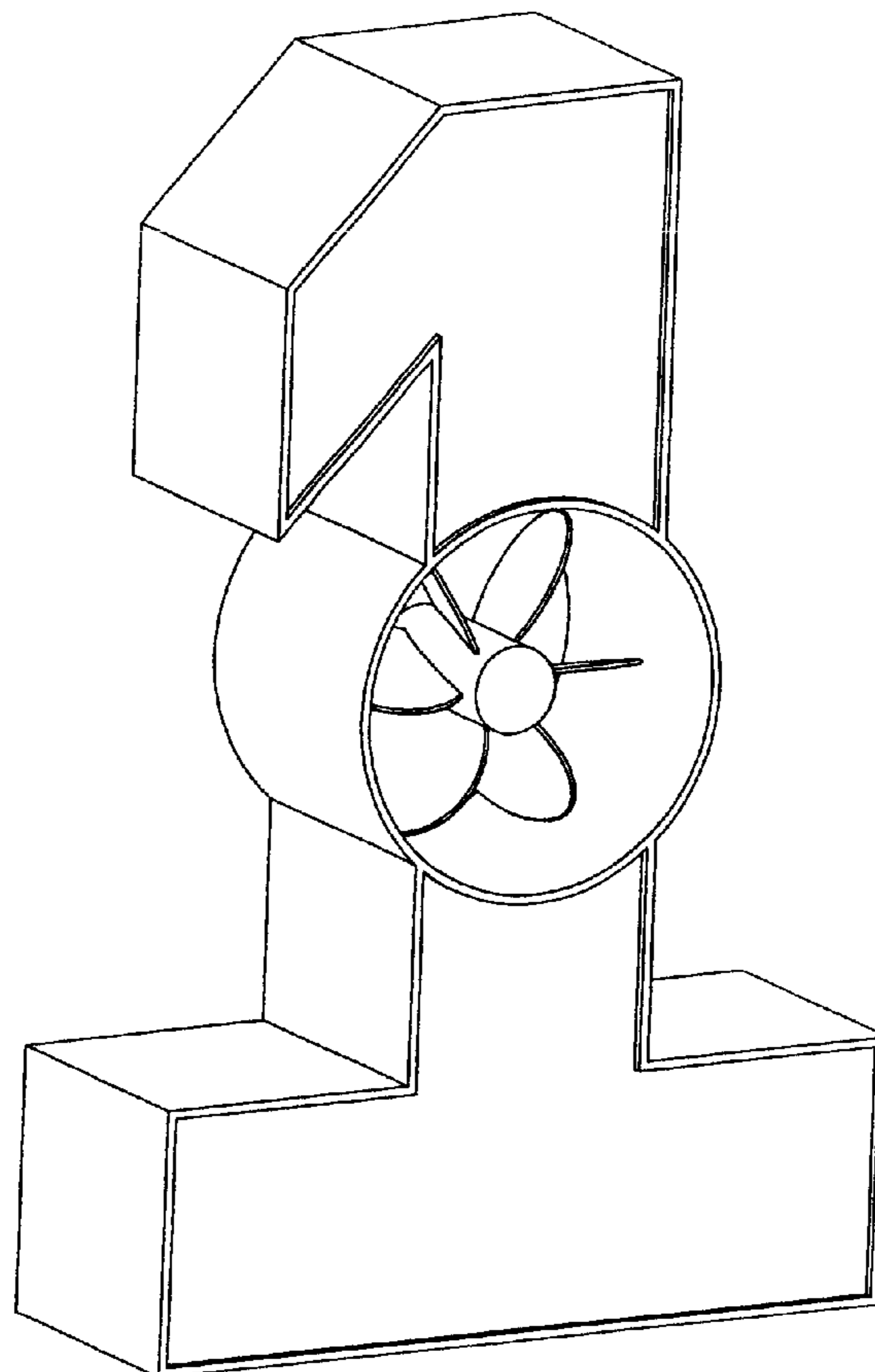

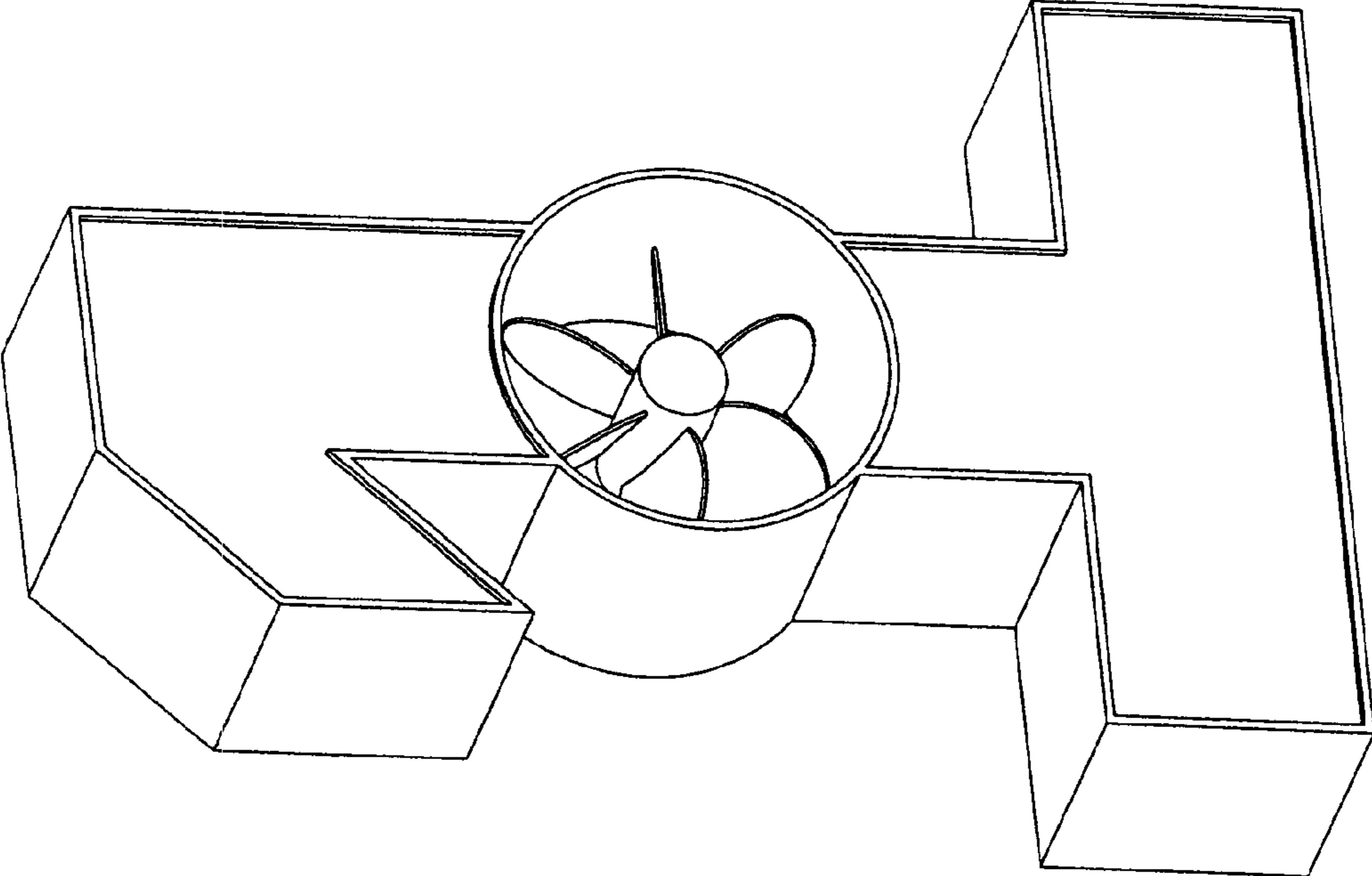

Figure 1

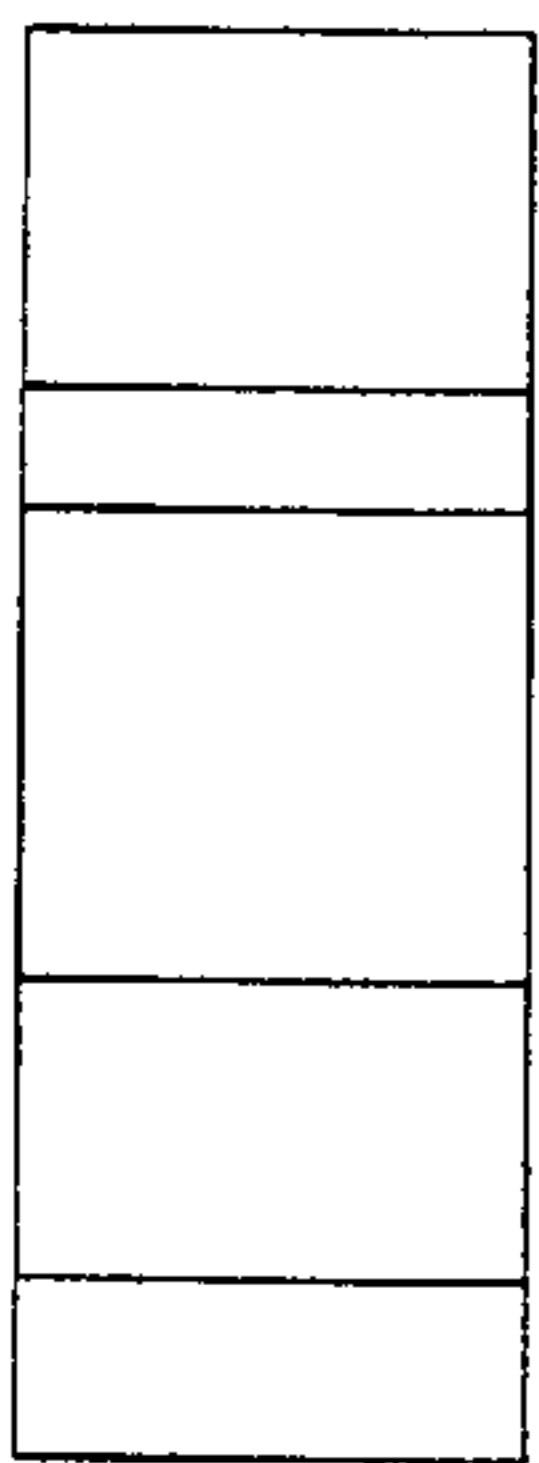

Figure 4

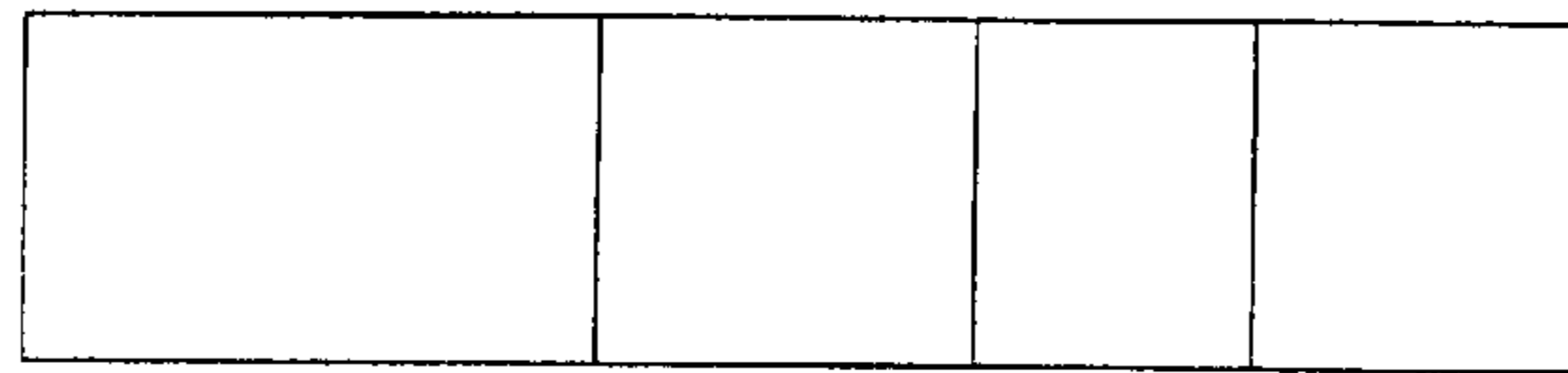

Figure 3

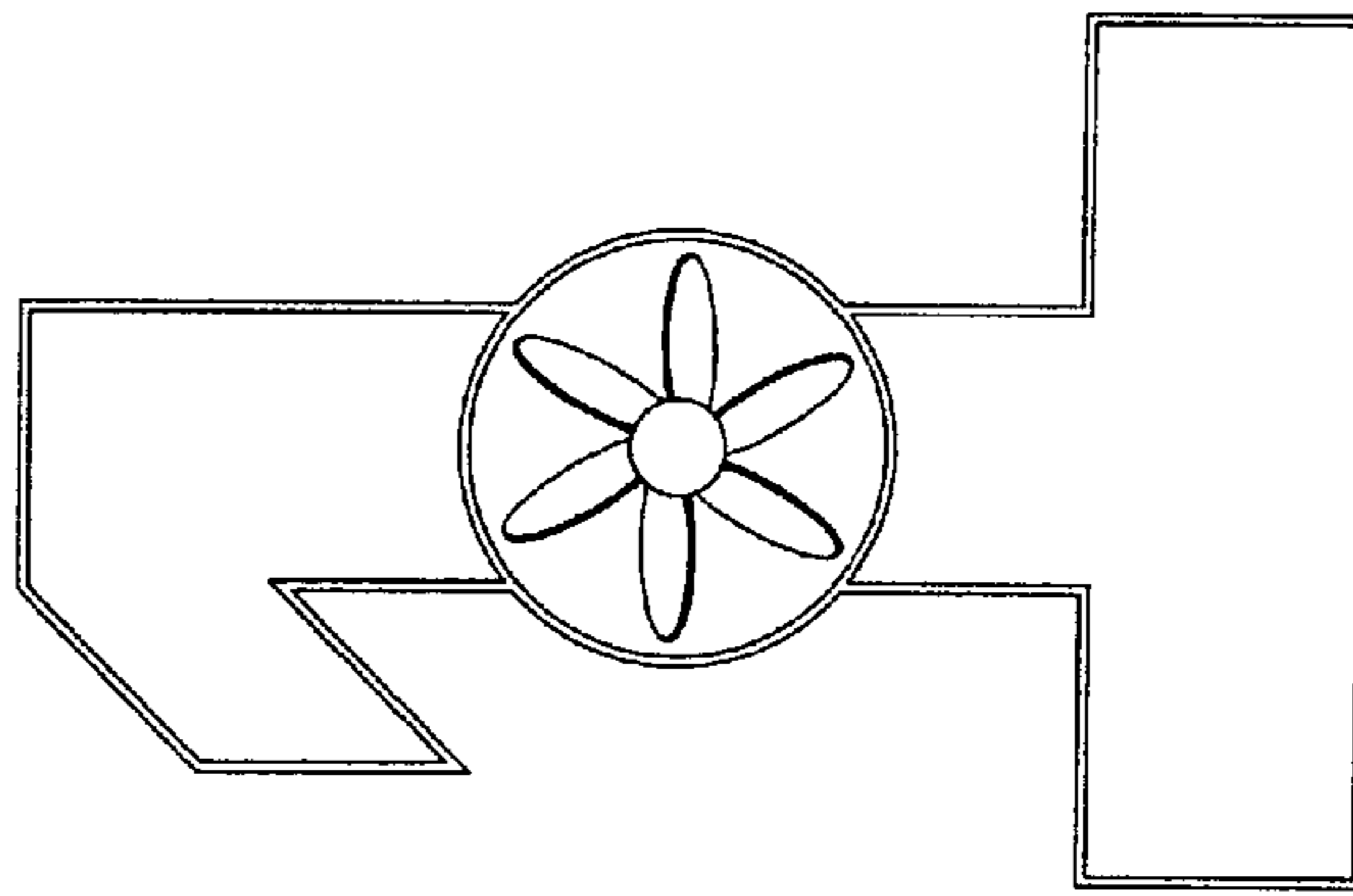

Figure 2

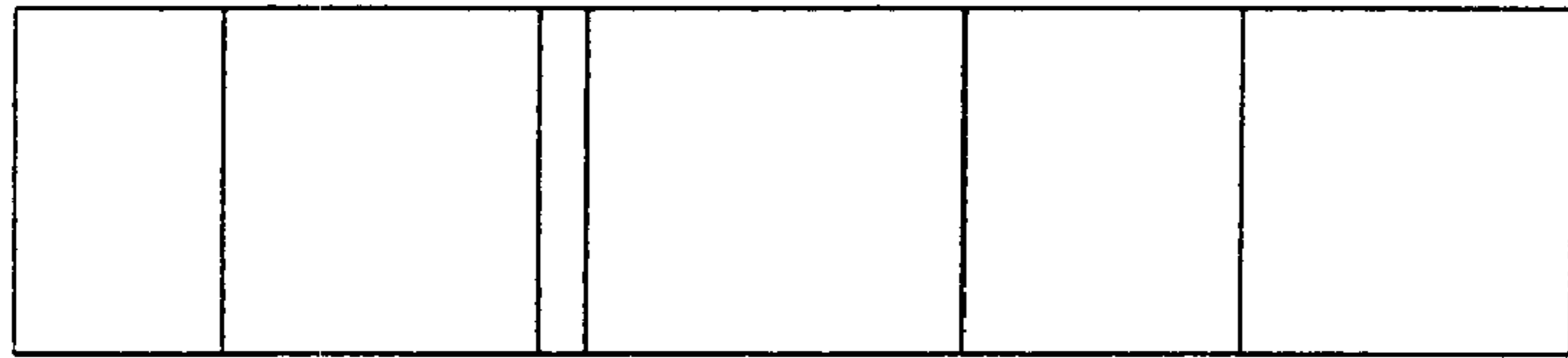

Figure 6

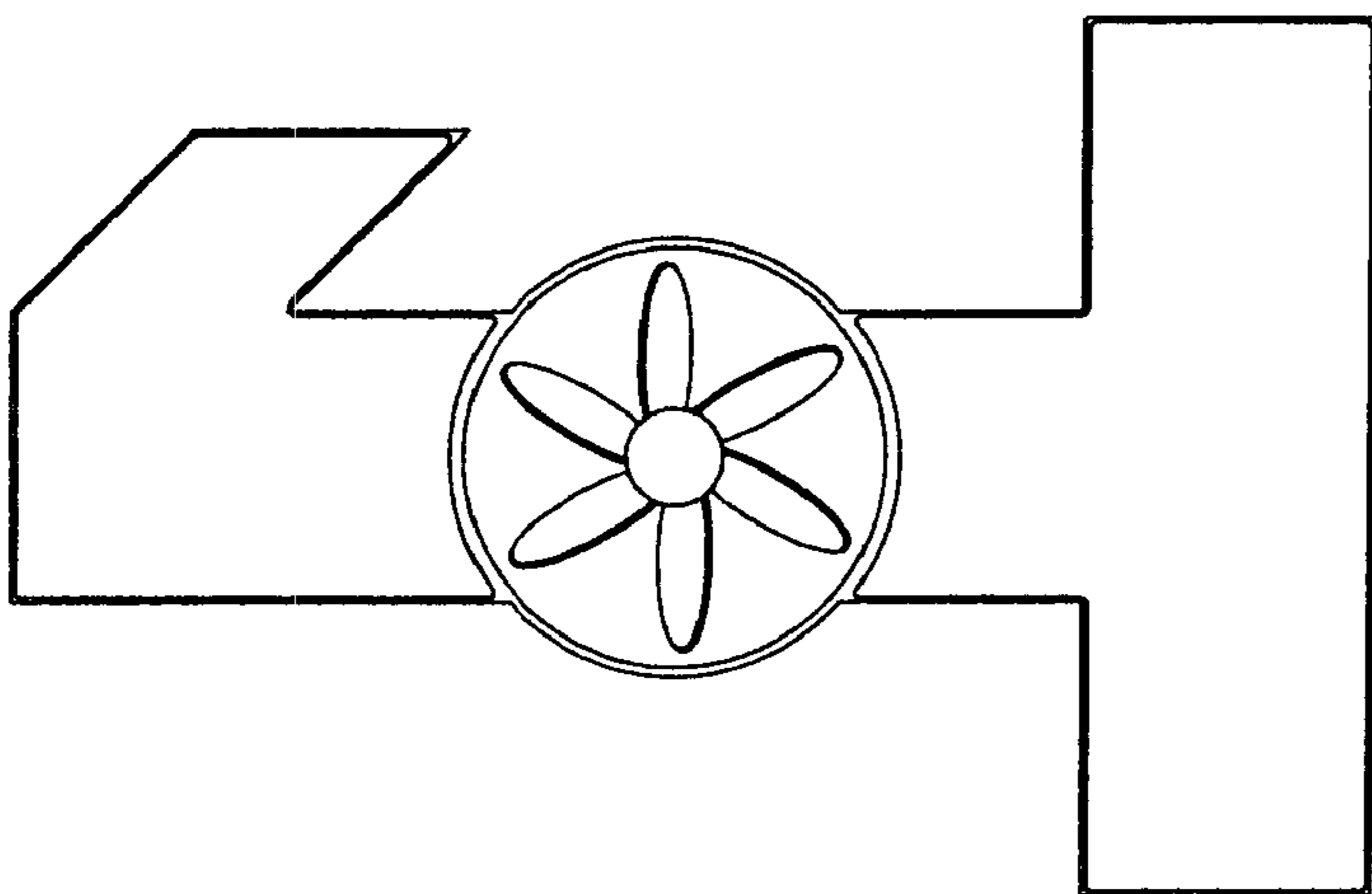

Figure 5

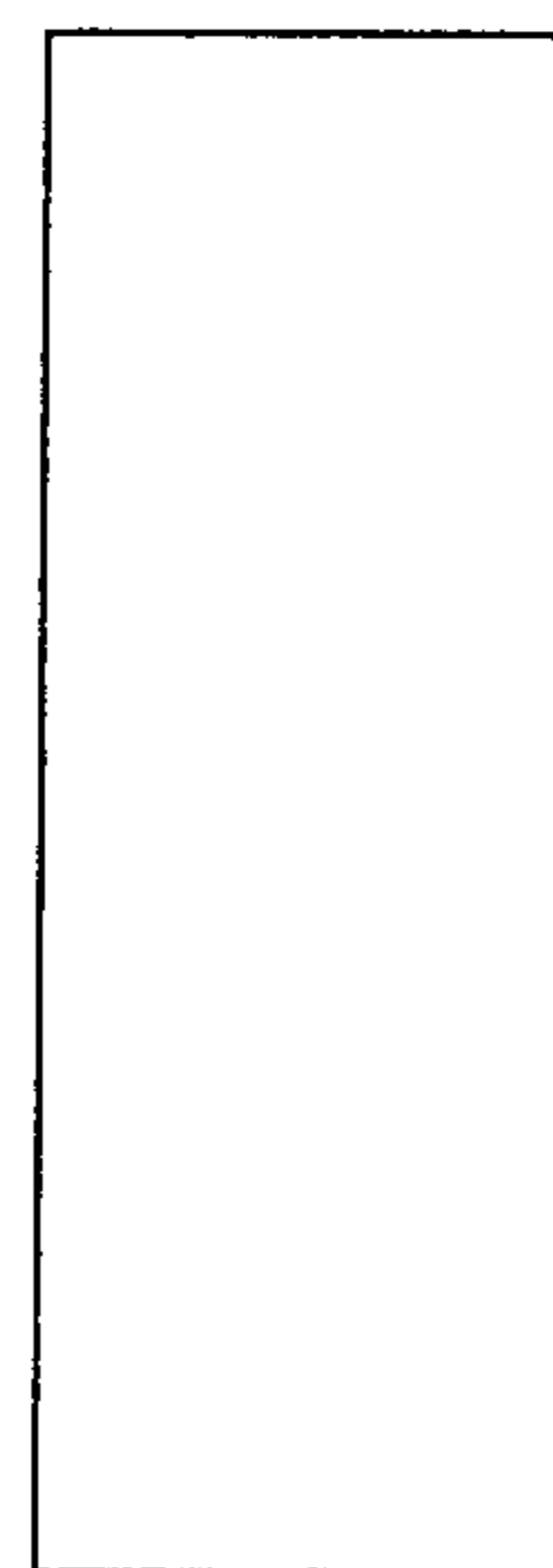

Figure 7