



US00D531145S

(12) **United States Design Patent**  
**Padain**

(10) **Patent No.:** **US D531,145 S**

(45) **Date of Patent:** **\*\* Oct. 31, 2006**

(54) **TELEVISION SET**

D496,042 S \* 9/2004 Borsboom ..... D14/371

(75) Inventor: **Chris Padain**, Bristol (GB)

\* cited by examiner

(73) Assignee: **Hannspree Inc.**, Taipei (TW)

*Primary Examiner*—Raphael Barkai

(\*\*) Term: **14 Years**

(74) *Attorney, Agent, or Firm*—Thomas, Kayden, Horstemeyer & Risley

(21) Appl. No.: **29/242,511**

(57) **CLAIM**

(22) Filed: **Nov. 10, 2005**

The ornamental design for a television set, as shown and described.

(30) **Foreign Application Priority Data**

Sep. 6, 2005 (TW) ..... 94305354

**DESCRIPTION**

(51) **LOC (8) Cl.** ..... **14-03**

FIG. 1 is a front perspective view thereof;

(52) **U.S. Cl.** ..... **D14/126**

FIG. 2 is a front elevational view thereof;

(58) **Field of Classification Search** ..... D14/125–134,  
D14/239, 371, 136, 374–377; 312/7.2; 348/836,  
348/838, 180, 184, 325, 739; 341/12; 248/917–924,  
248/465; 345/104, 133, 156, 168, 87, 173;  
720/605, 669, 600, 655; 369/99, 197; 455/344–347  
See application file for complete search history.

FIG. 3 is a rear elevational view thereof;

FIG. 4 is a left side elevational view thereof;

FIG. 5 is a right side elevational view thereof;

FIG. 6 is a top plan view thereof; and,

FIG. 7 is a bottom plan view thereof.

(56) **References Cited**

**U.S. PATENT DOCUMENTS**

D488,812 S \* 4/2004 Chiu ..... D14/375

**1 Claim, 7 Drawing Sheets**

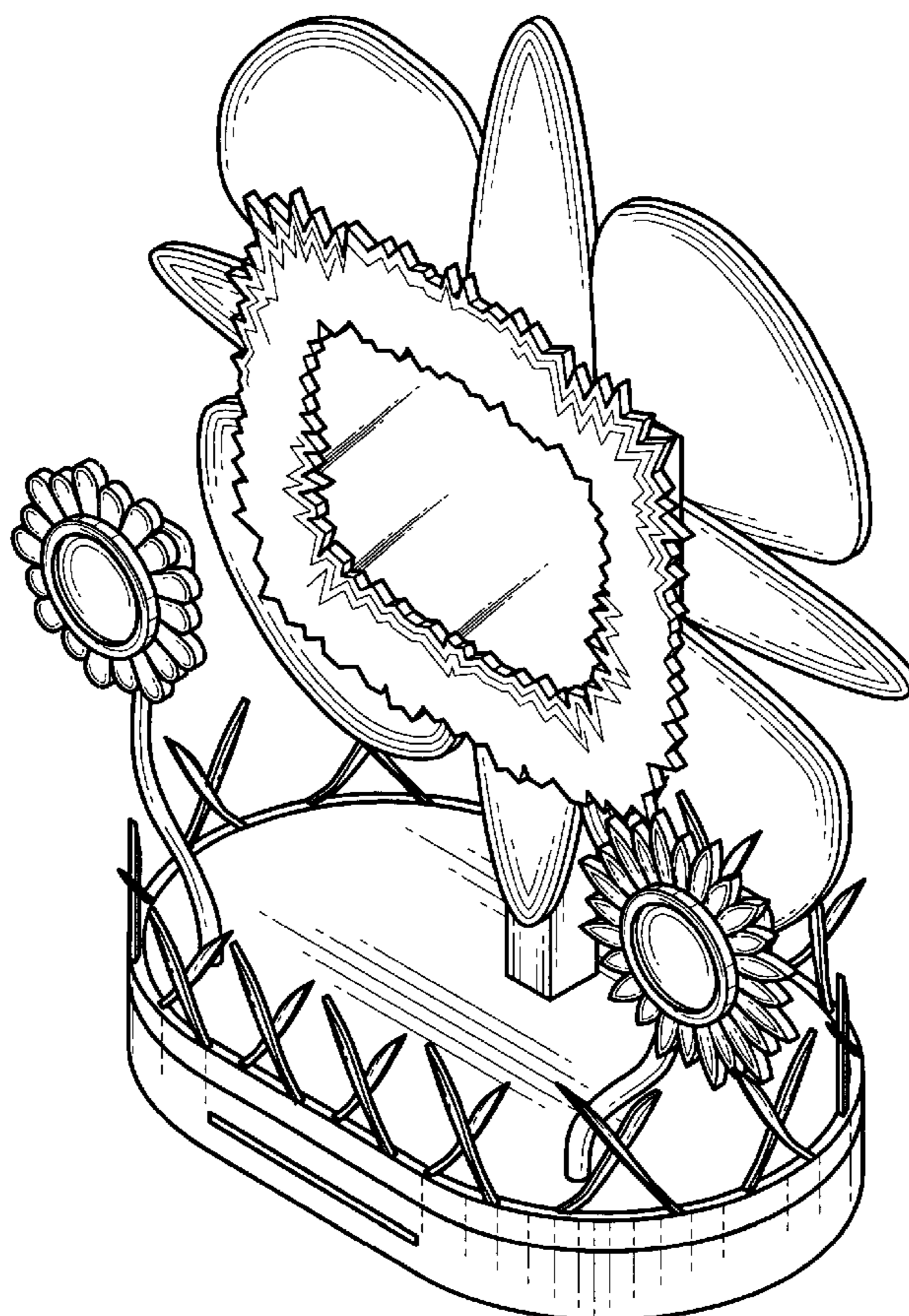

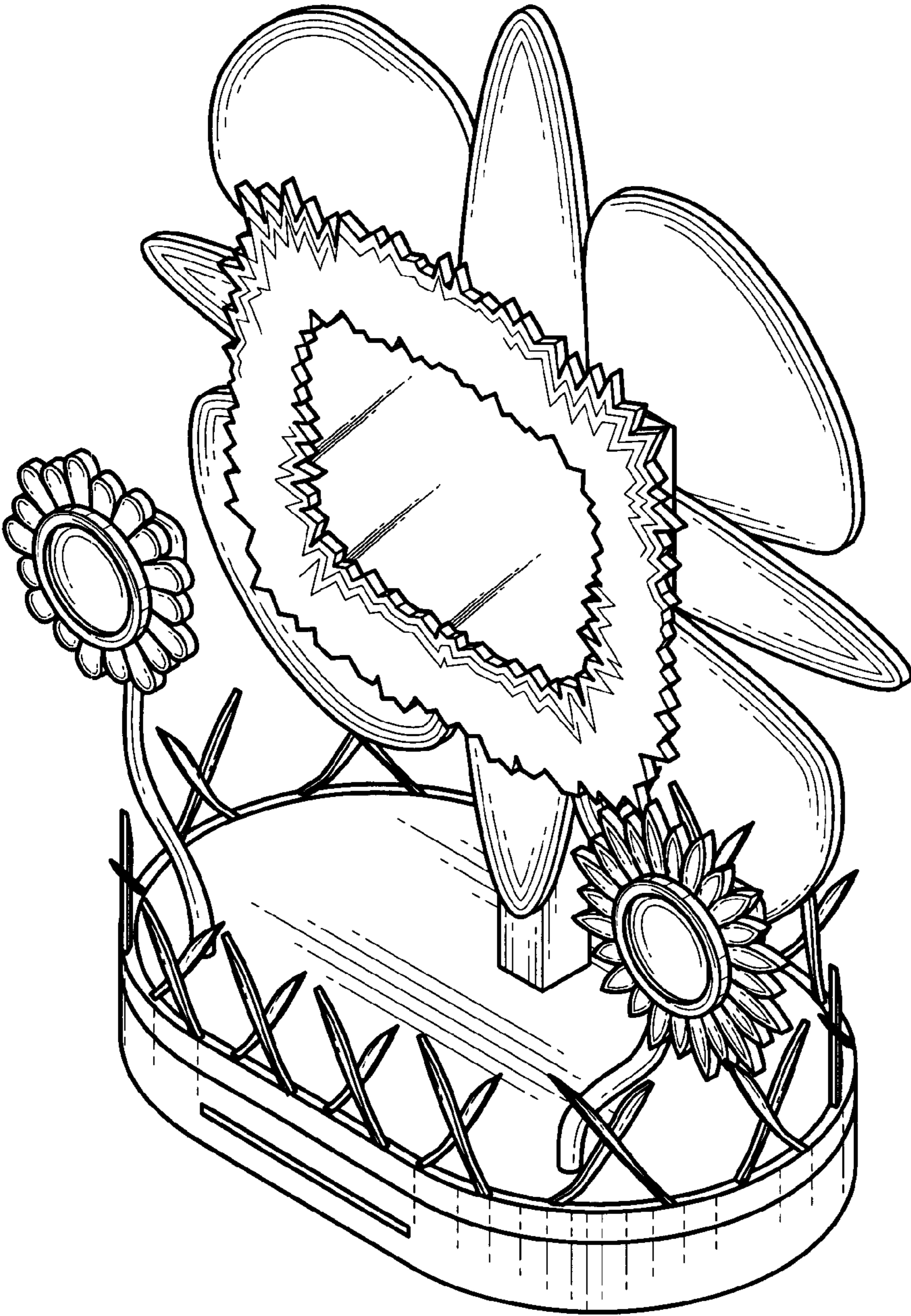

FIG. 1

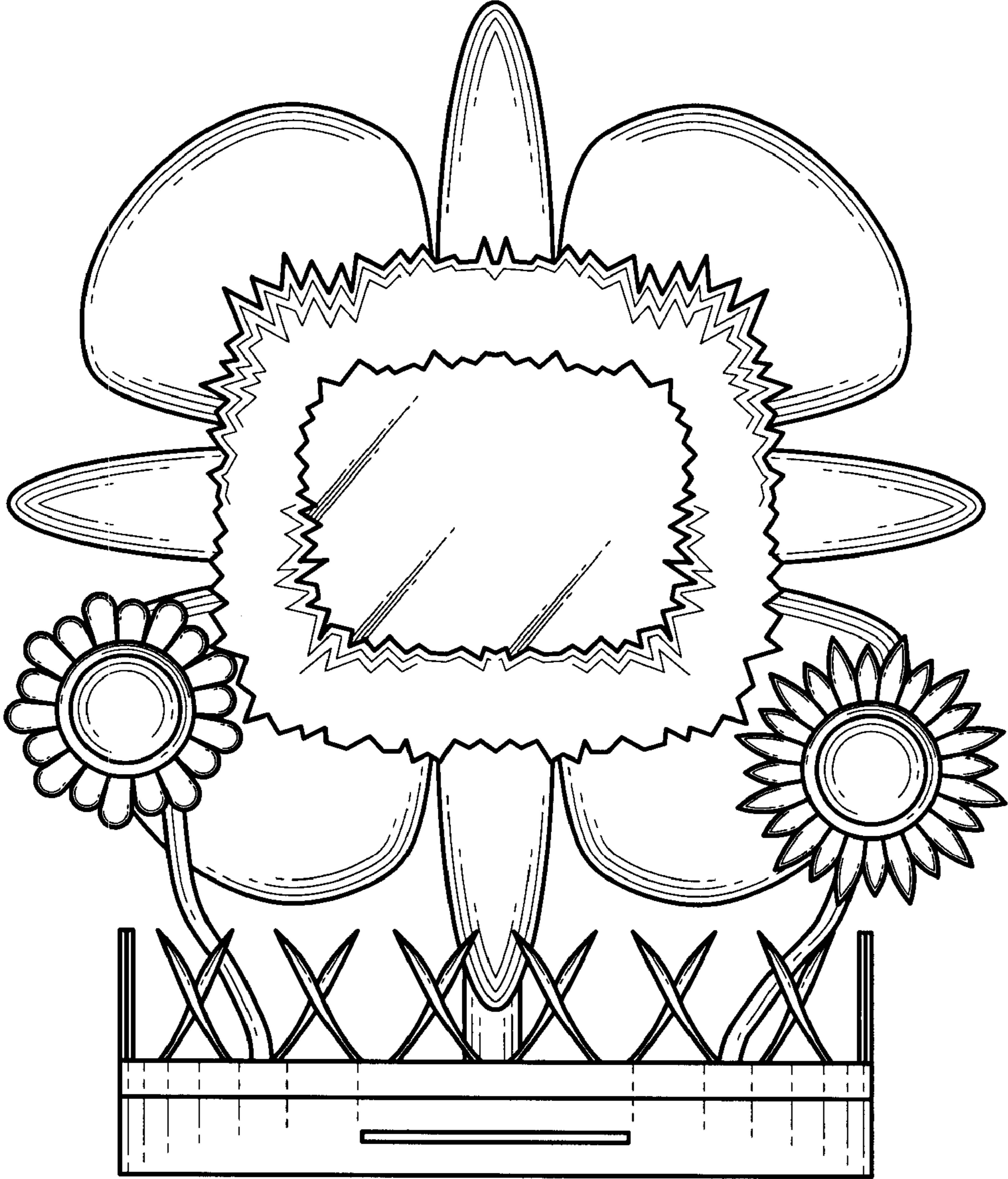

FIG. 2

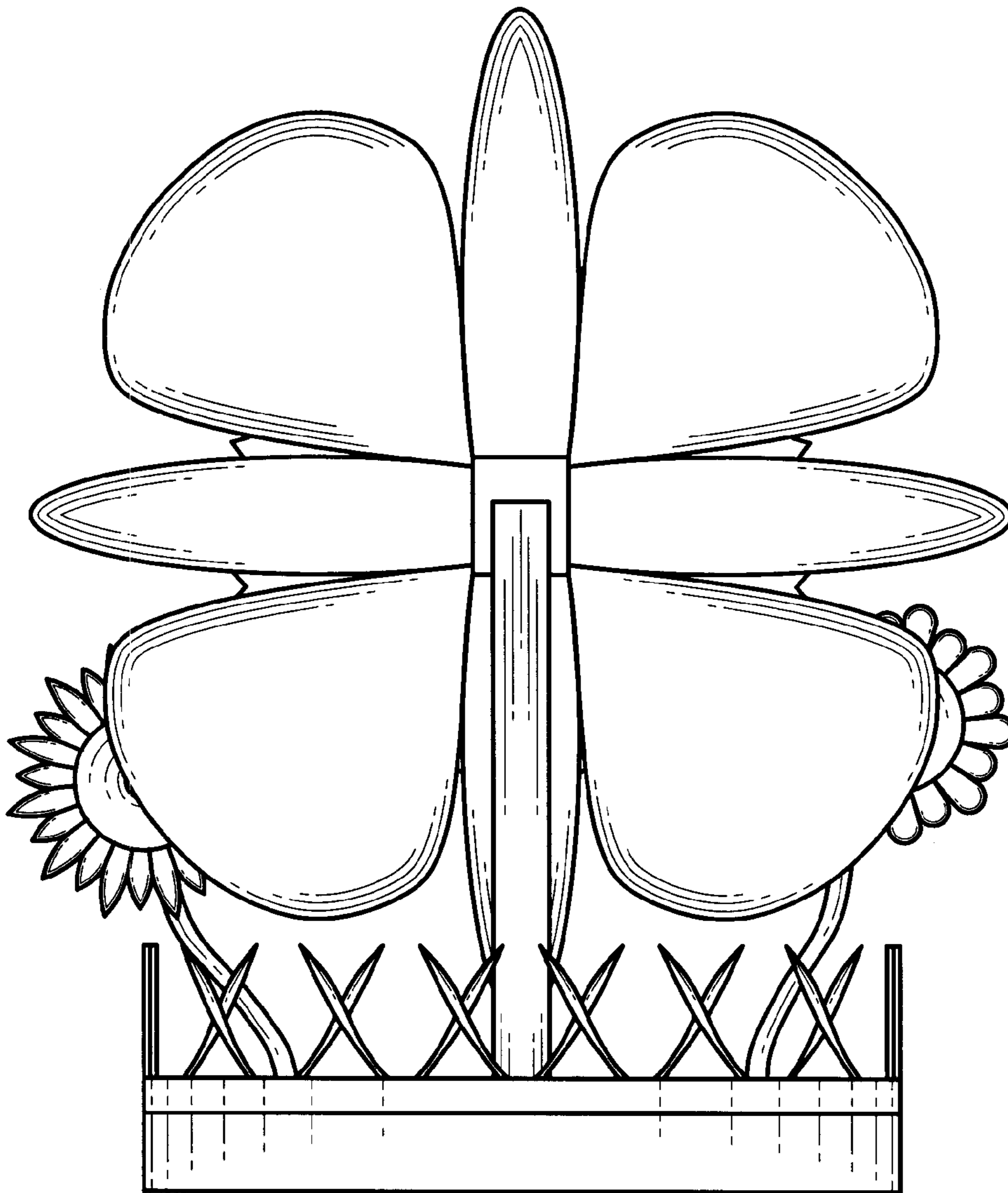

FIG. 3

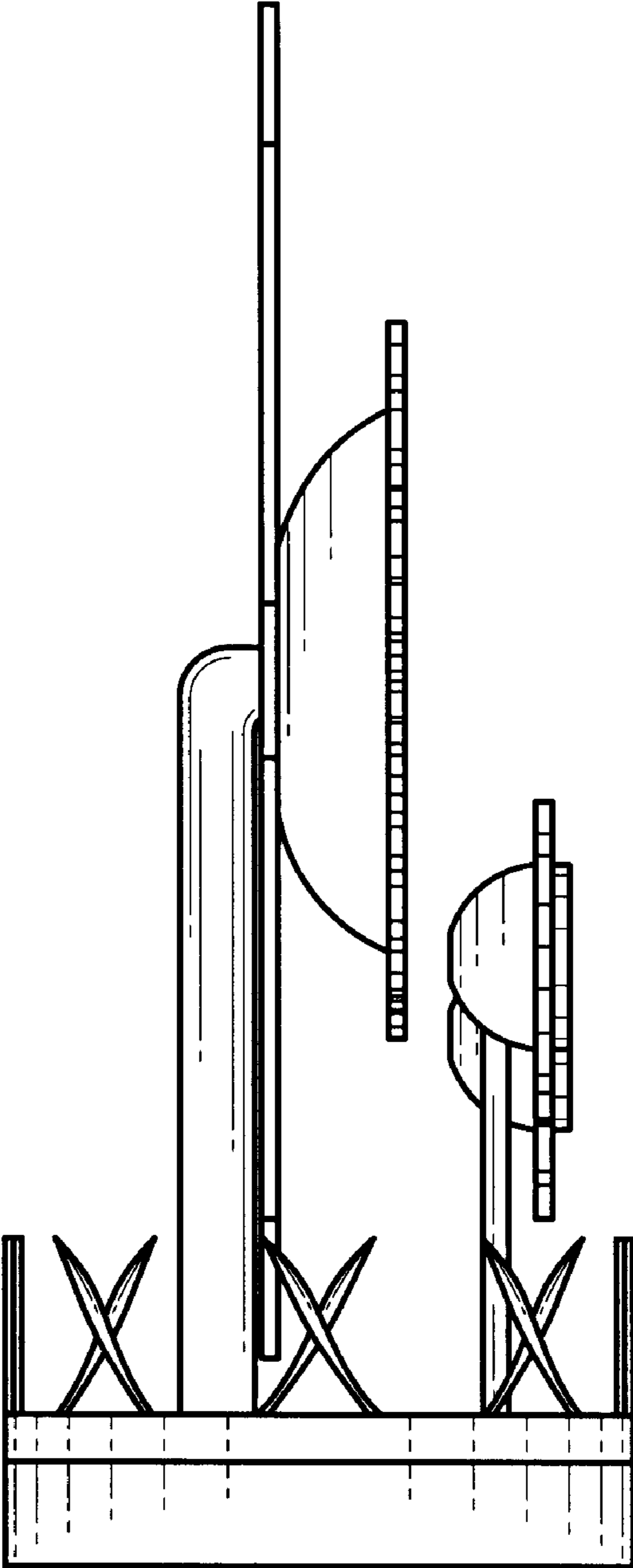

FIG. 4

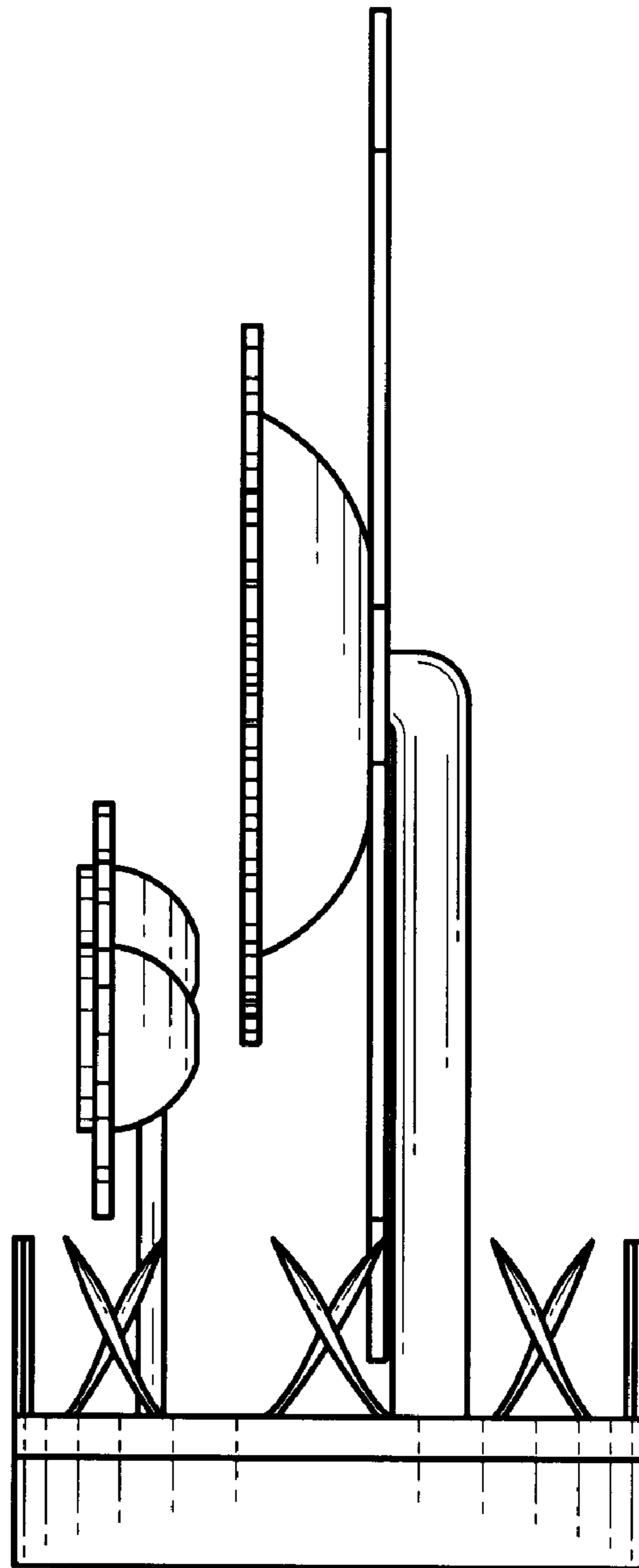

FIG. 5

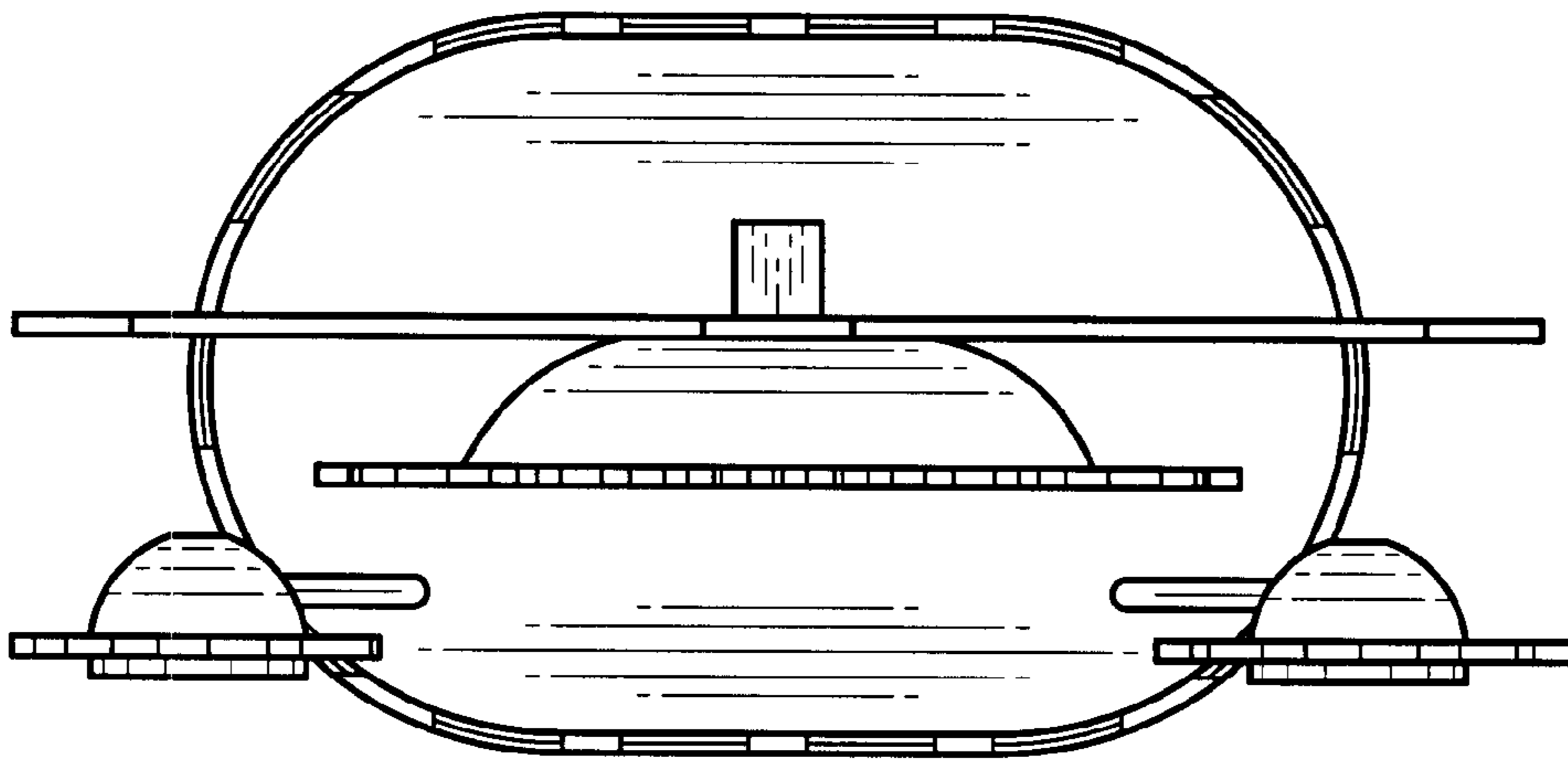

FIG. 6

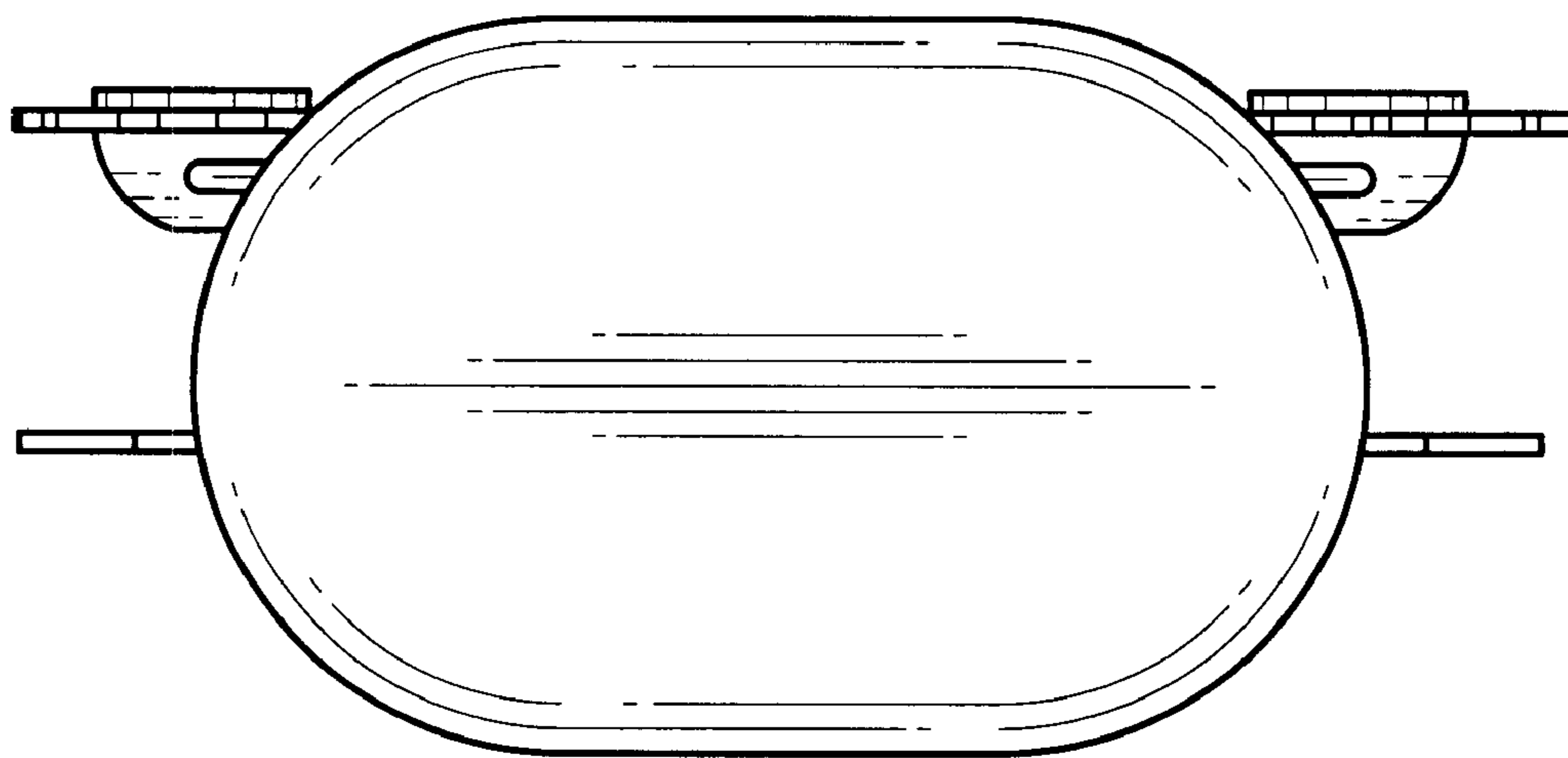

FIG. 7